



## Exchange release

30 August 2024

### 2024 US Annual Report (Form 20-F)<sup>1</sup>

---

BHP has filed its 2024 US Annual Report (Form 20-F) with the United States Securities and Exchange Commission.

The Form 20-F has been prepared in accordance with the requirements of the United States Securities and Exchange Commission and, as a result, does not comply with the reporting requirements under the Australasian Code for Reporting of Exploration Results, Mineral Resources and Ore Reserves (JORC Code, 2012 Edition).

The Form 20-F can be accessed at <https://www.bhp.com/news/media-centre/reports-presentations/2024/08/2024-annual-reporting-suite> or [www.sec.gov](http://www.sec.gov).

American Depositary Receipt holders may receive a hard copy of the company's complete audited financial statements free of charge upon request by telephoning Citibank Shareholder Services (+1 781) 575 4555 (outside US) or +1 877 248 4237 (+1 877 CITIADR) (toll free within US).

Authorised for release by Stefanie Wilkinson, Group Company Secretary.

---

<sup>1</sup> This release was made outside the hours of operation of the ASX market announcements office.

For personal use only



## Contacts

---

### Media

media.relations@bhp.com

### Australia and Asia

Gabrielle Notley  
+61 411 071 715

### Europe, Middle East and Africa

Neil Burrows  
+44 7786 661 683

### Americas

Renata Fernandez  
+56 9 8229 5357  
Megan Hjulfors  
+1 (403) 605-2314

### BHP Group Limited

ABN 49 004 028 077  
LEI WZE1WSENV6JSZFK0JC28  
Registered in Australia  
Level 18, 171 Collins Street  
Melbourne  
Victoria 3000 Australia  
Tel: +61 1300 55 4757 Fax: +61 3 9609 3015  
BHP Group is headquartered in Australia

**bhp.com**

### Investor Relations

investor.relations@bhp.com

### Australia and Asia

John-Paul Santamaria  
+61 499 006 018

### Europe, Middle East and Africa

James Bell  
+44 7961 636 432

### Americas

Monica Nettleton  
+1 (416) 518-6293

UNITED STATES  
SECURITIES AND EXCHANGE COMMISSION  
Washington, D.C. 20549

FORM 20-F

(Mark One)

- REGISTRATION STATEMENT PURSUANT TO SECTION 12(b) OR 12(g) OF THE SECURITIES EXCHANGE ACT OF 1934  
OR  
 ANNUAL REPORT PURSUANT TO SECTION 13 OR 15(d) OF THE SECURITIES EXCHANGE ACT OF 1934  
FOR THE FISCAL YEAR ENDED 30 JUNE 2024  
OR  
 TRANSITION REPORT PURSUANT TO SECTION 13 OR 15(d) OF THE SECURITIES EXCHANGE ACT OF 1934  
OR  
 SHELL COMPANY REPORT PURSUANT TO SECTION 13 OR 15(d) OF THE SECURITIES EXCHANGE ACT OF 1934

Date of event requiring this shell company report \_\_\_\_\_

Commission File No.: 001-09526

**BHP GROUP LIMITED**  
**(ABN 49 004 028 077)**

(Exact name of Registrant as specified in its charter)

N/A

(Translation of Registrant's name into English)

**VICTORIA, AUSTRALIA**

(Jurisdiction of incorporation or organization)

**171 COLLINS STREET**  
**MELBOURNE, VICTORIA 3000**  
**AUSTRALIA**

(Address of principal executive offices)

**STEFANIE WILKINSON**  
**BHP GROUP LIMITED**  
**171 COLLINS STREET**  
**MELBOURNE VIC 3000**  
**AUSTRALIA**

**TELEPHONE AUSTRALIA 1300 55 47 57**  
**TELEPHONE INTERNATIONAL +61 3 9609 3333**  
**FACSIMILE +61 3 9609 3015**  
(Name, telephone, e-mail and/or facsimile number and  
address of company contact person)

Securities registered or to be registered pursuant to Section 12(b) of the Act.

Title of each class	Trading symbol	Name of each exchange on which registered
American Depositary Shares*	BHP	New York Stock Exchange
Ordinary Shares**	BHP	New York Stock Exchange

\* Evidenced by American Depositary Receipts. Each American Depositary Receipt represents two ordinary shares of BHP Group Limited.  
\*\* Not for trading, but only in connection with the listing of the American Depositary Shares.

Securities registered or to be registered pursuant to Section 12(g) of the Act.

None  
(Title of Class)

Securities for which there is a reporting obligation pursuant to Section 15(d) of the Act.

None  
(Title of Class)

Indicate the number of outstanding shares of each of the issuer's classes of capital or common stock as of the close of the period covered by the annual report.

Ordinary Shares:

**BHP Group Limited**  
5,071,530,817

Indicate by check mark if the registrant is a well-known seasoned issuer, as defined in Rule 405 of the Securities Act. Yes  No

If this report is an annual or transition report, indicate by check mark if the registrant is not required to file reports pursuant to Section 13 or 15(d) of the Securities Exchange Act of 1934.  
Yes  No

Indicate by check mark whether the registrant (1) has filed all reports required to be filed by Section 13 or 15(d) of the Securities Exchange Act of 1934 during the preceding 12 months (or for such shorter period that the registrant was required to file such reports), and (2) has been subject to such filing requirements for the past 90 days. Yes  No

Indicate by check mark whether the registrant has submitted electronically every Interactive Data File required to be submitted pursuant to Rule 405 of Regulation S-T (§232.405 of this chapter) during the preceding 12 months (or for such shorter period that the registrant was required to submit such files). Yes  No

Indicate by check mark whether the registrant is a large accelerated filer, an accelerated filer, a non-accelerated filer, or an emerging growth company. See definition of "large accelerated filer," "accelerated filer," and "emerging growth company" in Rule 12b-2 of the Exchange Act.

Large accelerated filer  Accelerated filer   
Non-accelerated filer  Emerging growth company

If an emerging growth company that prepares its financial statements in accordance with U.S. GAAP, indicate by check mark if the registrant has elected not to use the extended transition period for complying with any new or revised financial accounting standards† provided pursuant to Section 13(a) of the Exchange Act.

† The term "new or revised financial accounting standard" refers to any update issued by the Financial Accounting Standards Board to its Accounting Standards Codification after April 5, 2012.

Indicate by check mark whether the registrant has filed a report on and attestation to its management's assessment of the effectiveness of its internal control over financial reporting under Section 404(b) of the Sarbanes-Oxley Act (15 U.S.C. 762(b)) by the registered public accounting firm that prepared or issued its audit report.

If securities are registered pursuant to Section 12(b) of the Act, indicate by check mark whether the financial statements of the registrant included in the filing reflect the correction of an error to previously issued financial statements.

Indicate by check mark whether any of those error corrections are restatements that required a recovery analysis of incentive-based compensation received by any of the registrant's executive officers during the relevant recovery period pursuant to §240.10D-1(b).

Indicate by check mark which basis of accounting the registrant has used to prepare the financial statements included in this filing:

U.S. GAAP  International Financial Reporting Standards as issued by the International Accounting Standards Board  Other

If "Other" has been checked in response to the previous question, indicate by check mark which financial statement item the registrant has elected to follow. Item 17  Item 18

If this is an annual report, indicate by check mark whether the registrant is a shell company (as defined in Rule 12b-2 of the Exchange Act). Yes  No

(APPLICABLE ONLY TO ISSUERS INVOLVED IN BANKRUPTCY PROCEEDINGS DURING THE PAST FIVE YEARS)

Indicate by check mark whether the registrant has filed all documents and reports required to be filed by Section 12, 13 or 15(d) of the Securities Exchange Act of 1934 subsequent to the distribution of securities under a plan confirmed by a court. Yes  No

## Company details

BHP Group Limited's registered office and global headquarters are at 171 Collins Street, Melbourne, Victoria 3000, Australia.

'BHP', the 'Company', the 'Group', 'BHP Group', 'our business', 'organisation', 'we', 'us', 'our' and 'ourselves' refer to BHP Group Limited, and except where the context otherwise requires, our subsidiaries.

Refer to Financial Statements note 30 'Subsidiaries' for a list of our significant subsidiaries and to Exhibit 8.1 – List of Subsidiaries for a list of our subsidiaries. Those terms do not include non-operated assets.

This Report covers functions and assets (including those under exploration, projects in development or execution phases, sites and operations that are closed or in the closure phase) that have been wholly owned and operated by BHP or that have been owned as a joint venture<sup>(1)</sup> operated by BHP (referred to in this Report as 'operated assets' or 'operations') from 1 July 2023 to 30 June 2024, unless otherwise stated. Certain sections of this Report include data in relation to the Daunia and Blackwater mines, which were divested during the year. Data in relation to the Daunia and Blackwater mines is shown for the period up to completion on 2 April 2024, unless stated otherwise. Some of the land and tenements related to the Daunia and Blackwater mines are pending transfer following completion, however given that the assets are no longer under BMA's control or operated for BMA's benefit (except for periods prior to completion or where specifically stated) data related to the land and tenements has been excluded from this Report.

BHP also holds interests in assets that are owned as a joint venture but not operated by BHP (referred to in this Report as 'non-operated joint ventures' or 'non-operated assets'). Notwithstanding that this Report may include production, financial and other information from non-operated assets, non-operated assets are not included in the BHP Group and, as a result, statements regarding our operations, assets and values apply only to our operated assets unless stated otherwise.

BHP Group Limited has a primary listing on the Australian Securities Exchange. BHP holds an international secondary listing on the London Stock Exchange, a secondary listing on the Johannesburg Stock Exchange and an ADR program listed on the New York Stock Exchange.

## Introduction

This document is our annual report on Form 20-F for the year ended 30 June 2024 (this "Annual Report"). Reference is made to our Australian Annual Report for the year ended 30 June 2024, which has been furnished to the U.S. Securities and Exchange Commission (the "SEC") on a Report on Form 6-K on 27 August 2024, which includes information that has been omitted from this Form 20-F. Only information that is included in, or expressly incorporated by reference into, this Form 20-F shall be deemed to form a part of this Annual Report.

The SEC maintains an Internet website that contains reports and other information regarding issuers that file electronically with the SEC. Our filings with the SEC are available to the public through the SEC's website at <http://www.sec.gov>.

Materiality, as used in the context of climate and sustainability-related disclosures, may differ from the materiality standards applied by other reporting regimes, including as defined for SEC reporting purposes. Any issues identified as material for purposes of sustainability in this document are therefore not necessarily material for SEC reporting purposes.

All references to websites in this Annual Report are intended to be inactive textual references for information only and any information contained in or accessible through any such website does not form a part of this Annual Report.

## Forward-looking statements

This Report contains forward-looking statements, which involve risks and uncertainties. Forward-looking statements include all statements, other than statements of historical or present facts, including: statements regarding trends in commodity prices and currency exchange rates; demand for commodities; global market conditions, reserves and resources estimates; development and production forecasts; guidance; expectations, plans, strategies and objectives of management; climate scenarios; approval of projects and consummation of transactions; closure, divestment, acquisition or integration of certain assets, operations or facilities (including associated costs or benefits); anticipated production or construction commencement dates; capital costs and scheduling; operating costs and availability of materials and skilled employees; anticipated productive lives of projects, mines and facilities; the availability, implementation and adoption of new technologies, including artificial intelligence; provisions and contingent liabilities; and tax, legal and other regulatory developments.

Forward-looking statements may be identified by the use of terminology, including, but not limited to, 'aim', 'ambition', 'anticipate', 'aspiration', 'believe', 'commit', 'continue', 'could', 'ensure', 'estimate', 'expect', 'forecast', 'goal', 'guidance', 'intend', 'likely', 'may', 'milestone', 'must', 'need', 'objective', 'outlook', 'pathways', 'plan', 'project', 'schedule', 'seek', 'should', 'target', 'trend', 'will', 'would', or similar words. These statements discuss future expectations or performance, or provide other forward-looking information.

(1) References in this Annual Report to a 'joint venture' are used for convenience to collectively describe assets that are not wholly owned by BHP. Such references are not intended to characterise the legal relationship between the owners of the asset.

Examples of forward-looking statements contained in this Report include, without limitation, statements describing (i) our strategy, our values and how we define our success; (ii) our expectations regarding future demand for certain commodities, in particular copper, nickel, iron ore, steelmaking coal, potash and steel, and our intentions, commitments or expectations with respect to our supply of certain commodities, including copper, nickel, iron ore, potash, uranium and gold; (iii) our future exploration and partnership plans and perceived benefits and opportunities, including our focus to grow our copper and potash assets; (iv) our business outlook, including our outlook for long-term economic growth and other macroeconomic and industry trends; (v) our projected and expected production and performance levels and development projects; (vi) our expectations regarding our investments, including in potential growth options and technology and innovation, and perceived benefits and opportunities; (vii) our reserves and resources estimates; (ix) our plans for our major projects and related budget and capital allocations; (x) our expectations, commitments and objectives with respect to sustainability, decarbonisation, natural resource management, climate change and portfolio resilience and timelines and plans to seek to achieve or implement such objectives, including our approach to equitable change and transitions, our Climate Transition Action Plan, climate change adaptation strategy and goals, targets, pathways and strategies to seek to reduce or support the reduction of greenhouse gas emissions, and related perceived costs, benefits and opportunities for BHP; (xi) the assumptions, beliefs and conclusions in our climate change related statements and strategies, including in our Climate Change Report 2020, for example, in respect of future temperatures, energy consumption and greenhouse gas emissions, and climate-related impacts; (xii) our commitment to social value; (xiii) our commitments to sustainability reporting, frameworks, standards and initiatives; (xiv) our commitments to improve or maintain safe tailings storage management; (xv) our commitments to achieve certain inclusion and diversity targets, aspirations and outcomes; (xvi) our commitments to achieve certain targets and outcomes with respect to Indigenous peoples and the communities where we operate; and (xvii) our commitments to achieve certain health and safety targets and outcomes.

Forward-looking statements are based on management's expectations and reflect judgements, assumptions, estimates and other information available, as at the date of this Report. These statements do not represent guarantees or predictions of future financial or operational performance and involve known and unknown risks, uncertainties and other factors, many of which are beyond our control and which may cause actual results to differ materially from those expressed in the statements contained in this Report. BHP cautions against reliance on any forward-looking statements.

For example, our future revenues from our assets, projects or mines described in this Report will be based, in part, on the market price of the commodities produced, which may vary significantly from current levels or those reflected in our reserves and resources estimates. These variations, if materially adverse, may affect the timing or the feasibility of the development of a particular project, the expansion of certain facilities or mines, or the continuation of existing assets.

Other factors that may affect our future operations and performance, including the actual construction or production commencement dates, revenues, costs or production output and anticipated lives of assets, mines or facilities include: (i) our ability to profitably produce and deliver the products extracted to applicable markets; (ii) the impact of economic and geopolitical factors, including foreign currency exchange rates on the market prices of the commodities we produce and competition in the markets in which we operate; (iii) activities of government authorities in the countries where we sell our products and in the countries where we are exploring or developing projects, facilities or mines, including increases in taxes and royalties or implementation of trade or export restrictions; (iv) changes in environmental and other regulations; (v) political or geopolitical uncertainty; (vi) labour unrest; (vii) weather, climate variability or other manifestations of climate change; and (viii) other factors identified in the risk factors set out in OFR 3.1.

In addition, there are limitations with respect to scenario analysis, including any climate-related scenario analysis, and it is difficult to predict which, if any, of the scenarios might eventuate. Scenario analysis is not an indication of probable outcomes and relies on assumptions that may or may not prove to be correct or eventuate.

Except as required by applicable regulations or by law, BHP does not undertake to publicly update or review any forward-looking statements, whether as a result of new information or future events.

Past performance cannot be relied on as a guide to future performance.

### **Emissions and energy consumption data**

Due to the inherent uncertainty and limitations in measuring GHG emissions and operational energy consumption under the calculation methodologies used in the preparation of such data, all GHG emissions and operational energy consumption data or references to GHG emissions and operational energy consumption volumes (including ratios or percentages) in this Report are estimates. There may also be differences in the manner that third parties calculate or report GHG emissions or operational energy consumption data compared to BHP, which means third-party data may not be comparable to our data. For information on how we calculate our GHG emissions and operational energy consumption, refer to the BHP GHG Emissions Calculation Methodology 2024, available at [bhp.com/climate](http://bhp.com/climate)

Form 20-F Cross Reference Table

Item Number	Description	Report section reference
1.	<b>Identity of Directors, Senior Management and Advisors</b>	Not applicable
2.	<b>Offer Statistics and Expected Timetable</b>	Not applicable
3.	<b>Key Information</b>	
A	[Reserved]	Not applicable
B	Capitalization and indebtedness	Not applicable
C	Reasons for the offer and use of proceeds	Not applicable
D	Risk factors	8.1
4.	<b>Information on the Company</b>	
A	History and development of the company	Cover page, Company details, Chair's review, Chief Executive Officer's review, Operating and Financial Review 1 to 9, Additional information 1, 2, 4 to 9.4
B	Business overview	Operating and Financial Review 1 to 5, 9, Additional information 1, 4 to 8, 9.3, 9.9 and Note 1 to the Financial Statements
C	Organizational structure	Additional information 9.3 and Note 30 to the Financial Statements
D	Property, plants and equipment	Operating and Financial Review 3, 5.1, 5.2, 5.3, 6 to 9, Additional information 1, 4 to 6 and Notes 11, 15 and 22 to the Financial Statements
4A.	<b>Unresolved Staff Comments</b>	None
5.	<b>Operating and Financial Review and Prospects</b>	
A	Operating results	Operating and Financial Review 4, 5, 9, Additional information 2 to 4
B	Liquidity and capital resources	Operating and Financial Review 4, Financial Statements 1.4, Notes 11 and 21 to 24 to the Financial Statements
C	Research and development, patents and licenses, etc.	Operating and Financial Review 3, 5, 8 and 9, Directors' Report 10, Additional information 1, 5, 6 and Notes 11 and 15 to the Financial Statements
D	Trend information	Chair's review, Chief Executive Officer's review, Operating and Financial Review 1 to 6, 8, 9, Additional information 1 to 7
E	Critical Accounting Estimates	IFRS is applied in the Financial Statements as issued by the IASB
6.	<b>Directors, Senior Management and Employees</b>	
A	Directors and senior management	Corporate Governance Statement 4.1, 6.1, Directors' Report 2
B	Compensation	Remuneration Report
C	Board practices	Corporate Governance Statement 4.1, 4.7, 5.2, 5.4, Remuneration Report
D	Employees	Operating and Financial Review 6.6, Additional information 7
E	Share ownership	Remuneration Report, Directors' Report 3, 4 and Notes 17, 18, 25 and 26 to the Financial Statements
F	Erroneously Awarded Compensation	Not applicable
7.	<b>Major Shareholders and Related Party Transactions</b>	
A	Major shareholders	Additional information 9.5
B	Related party transactions	Remuneration Report and Notes 25 and 33 to the Financial Statements
C	Interests of experts and counsel	Not applicable
8.	<b>Financial Information</b>	

A	Consolidated Statements and Other Financial Information	Operating and Financial Review 7, Additional information 8, 9.6, Financial Statements beginning on page F-1 in this Annual Report and Financial Statements 1A
B	Significant Changes	Note 35 to the Financial Statements
9.	<b>The Offer and Listing</b>	
A	Offer and listing details	Additional information 9.2
B	Plan of distribution	Not applicable
C	Markets	Additional information 9.2
D	Selling shareholders	Not applicable
E	Dilution	Not applicable
F	Expenses of the issue	Not applicable
10.	<b>Additional Information</b>	
A	Share capital	Not applicable
B	Memorandum and articles of association	Additional information 9.3, 9.4
C	Material contracts	Additional Information 8 (regarding the Framework Agreement)
D	Exchange controls	Additional information 9.9
E	Taxation	Additional information 9.10
F	Dividends and paying agents	Not applicable
G	Statement by experts	Not applicable
H	Documents on display	Additional information 9.4
I	Subsidiary information	Note 30 to the Financial Statements and Exhibit 8.1
J	Annual Report to Security Holders	Not applicable
11.	<b>Quantitative and Qualitative Disclosures About Market Risk</b>	Note 24 to the Financial Statements
12.	<b>Description of Securities Other than Equity Securities</b>	
A	Debt Securities	Not applicable
B	Warrants and Rights	Not applicable
C	Other Securities	Not applicable
D	American Depositary Shares	Additional information 9.7 and Exhibit 2.1
13.	<b>Defaults, Dividend Arrearages and Delinquencies</b>	Not applicable
14.	<b>Material Modifications to the Rights of Security Holders and Use of Proceeds</b>	Not applicable
15.	<b>Controls and Procedures</b>	Corporate Governance Statement 9.2 and Financial Statements 1A
16A.	<b>Audit committee financial expert</b>	Corporate Governance Statement 5.2
16B.	<b>Code of Ethics</b>	Corporate Governance Statement 8
16C.	<b>Principal Accountant Fees and Services</b>	Corporate Governance Statement 9.2 and Note 36 to the Financial Statements
16D.	<b>Exemptions from the Listing Standards for Audit Committees</b>	Not applicable
16E.	<b>Purchases of Equity Securities by the Issuer and Affiliated Purchasers</b>	Directors' Report 4
16F.	<b>Change in Registrant's Certifying Accountant</b>	Not applicable
16G.	<b>Corporate Governance</b>	Corporate Governance Statement
16H.	<b>Mine Safety Disclosure</b>	Not applicable
16I.	<b>Disclosure Regarding Foreign Jurisdictions that Prevent Inspections</b>	Not applicable
16J.	<b>Insider Trading Policies</b>	Exhibit 11.1
16K.	<b>Cybersecurity</b>	Operating and Financial Review 8.1, Additional information 9.8
17.	<b>Financial Statements</b>	Not applicable
18.	<b>Financial Statements</b>	Financial Statements begin on page F-1 in this Annual Report
19.	<b>Exhibits</b>	Exhibits



**Bringing people and resources together to build a better world.**

“A resource mix for today. Critical for the future. Our project pipeline and focus on continuous improvement in existing operations leave us well poised for growth across our four commodity pillars of copper, potash, iron ore and steelmaking coal in the decades ahead.”

Mike Henry

Chief Executive Officer

For personal use only



## Contents

<a href="#">Chair's review</a>	1
<a href="#">Chief Executive Officer's review</a>	3
<b>Operating and Financial Review</b>	
1 <a href="#">Why BHP</a>	5
1.1 <a href="#">Where we operate</a>	7
1.2 <a href="#">Our portfolio</a>	8
2 <a href="#">What differentiates us</a>	10
3 <a href="#">Positioning for growth</a>	15
4 <a href="#">Financial review</a>	18
4.1 <a href="#">Group overview</a>	18
4.2 <a href="#">Key performance indicators</a>	18
4.3 <a href="#">Financial results</a>	20
4.4 <a href="#">Debt and sources of liquidity</a>	22
5 <a href="#">Our assets</a>	25
5.1 <a href="#">Minerals Australia</a>	25
5.2 <a href="#">Copper South Australia</a>	28
5.3 <a href="#">Minerals Americas</a>	29
5.4 <a href="#">Commercial</a>	32
6 <a href="#">Sustainability</a>	34
6.1 <a href="#">Safety</a>	34
6.2 <a href="#">Our sustainability approach</a>	37
6.3 <a href="#">Sustainability governance</a>	37
6.4 <a href="#">Material sustainability topics for reporting</a>	38
6.5 <a href="#">2030 goals</a>	40
6.6 <a href="#">People</a>	43
6.7 <a href="#">Health</a>	50
6.8 <a href="#">Ethics and business conduct</a>	53
6.9 <a href="#">Climate change</a>	55
6.10 <a href="#">Environment and nature</a>	70
6.11 <a href="#">Community</a>	77
6.12 <a href="#">Indigenous peoples</a>	79
6.13 <a href="#">Independent limited assurance report</a>	83
7 <a href="#">Samarco</a>	84
8 <a href="#">How we manage risk</a>	85
8.1 <a href="#">Risk factors</a>	87
8.2 <a href="#">Management of risks</a>	92
9 <a href="#">Performance by commodity</a>	99

9.1	<a href="#">Copper</a>	99
9.2	<a href="#">Iron ore</a>	100
9.3	<a href="#">Coal</a>	101
9.4	<a href="#">Other assets</a>	102
9.5	<a href="#">Impact of changes to commodity prices</a>	103
10	<a href="#">Non-IFRS financial information</a>	104
10.1	<a href="#">Definition and calculation of non-IFRS financial information</a>	116
10.2	<a href="#">Definition and calculation of principal factors</a>	119
11	<a href="#">Other information</a>	120
11.1	<a href="#">Company details</a>	120
11.2	<a href="#">Forward-looking statements</a>	120
<b>Governance</b>		
	<a href="#">Corporate Governance Statement</a>	121
1	<a href="#">Corporate governance at BHP</a>	121
2	<a href="#">FY2024 corporate governance highlights</a>	121
3	<a href="#">BHP's governance structure</a>	122
4	<a href="#">Board composition and succession</a>	123
5	<a href="#">Board Committees</a>	132
6	<a href="#">Management</a>	135
7	<a href="#">Shareholders and reporting</a>	136
8	<a href="#">Culture and conduct</a>	138
9	<a href="#">Risk management and assurance</a>	139
10	<a href="#">US requirements</a>	142
	<a href="#">Directors' Report</a>	143
1	<a href="#">Review of operations, principal activities and state of affairs</a>	143
2	<a href="#">Directors</a>	143
3	<a href="#">Share interests</a>	144
4	<a href="#">Share capital and buy-back programs</a>	145
5	<a href="#">Group Company Secretary</a>	145
6	<a href="#">Indemnities and insurance</a>	145
7	<a href="#">Dividends</a>	145
8	<a href="#">Auditors</a>	145
9	<a href="#">Non-audit services</a>	145
10	<a href="#">Exploration, research and development</a>	146
11	<a href="#">ASIC Instrument 2016/191</a>	146
12	<a href="#">Proceedings on behalf of BHP Group Limited</a>	146
13	<a href="#">Performance in relation to environmental regulation</a>	146
14	<a href="#">Additional information</a>	146

<a href="#">Remuneration Report</a>	147
<a href="#">People and Remuneration Committee Chair letter to shareholders</a>	148
1 <a href="#">Remuneration governance</a>	151
2 <a href="#">Executive KMP remuneration framework</a>	152
3 <a href="#">Remuneration for the CEO and other Executive KMP</a>	155
4 <a href="#">Remuneration for Non-executive Directors</a>	162
5 <a href="#">Statutory KMP remuneration and other disclosures</a>	164
<b><a href="#">Financial Statements</a></b>	171
<b>Additional information</b>	
1 <a href="#">Information on mining operations</a>	172
2 <a href="#">Financial information summary</a>	195
3 <a href="#">Financial information by commodity</a>	196
4 <a href="#">Production</a>	198
5 <a href="#">Major projects</a>	201
6 <a href="#">Mineral resources and mineral reserves</a>	202
7 <a href="#">People - performance data</a>	225
8 <a href="#">Legal proceedings</a>	227
9 <a href="#">Shareholder information</a>	231
9.1 <a href="#">History and development</a>	231
9.2 <a href="#">Markets</a>	231
9.3 <a href="#">Organisational structure</a>	232
9.4 <a href="#">Constitution</a>	232
9.5 <a href="#">Share ownership</a>	235
9.6 <a href="#">Dividends</a>	238
9.7 <a href="#">American Depositary Receipts fees and charges</a>	238
9.8 <a href="#">Supplemental cybersecurity disclosures for US reporting</a>	239
9.9 <a href="#">Government regulations</a>	240
9.10 <a href="#">Taxation</a>	243
10 <a href="#">Glossary</a>	247
<b><a href="#">Exhibits</a></b>	263

## Our performance highlights

### Operational



#### Highest copper production in over 15 years

Highest production in four years at Escondido, record production at Spence and Carrapateena, and successful integration at Copper South Australia.



#### Production record at WAIQ

Second consecutive year of record iron ore production at WAIQ, through ongoing incremental supply chain improvements.



#### Refining our steelmaking coal portfolio

Successfully completed the sale of Blackwater and Duma, further focusing our portfolio on higher-quality steelmaking coal.



#### Jansen potash project tracking to plan

Jansen Stage 1 more than 50 per cent complete. We are on track to be a major global producer of potash by the end of the decade.

### Financial



#### Dividend per share

**146USc**  
FY2023 170c



#### Profit from operations

**US\$17.5bn**  
FY2023 16.2bn

### Social value



#### Decarbonisation

Operational greenhouse gas (GHG) emissions (Scopes 1 and 2 emissions)  
**↑1% on FY2023**  
but remain on track to meet our medium-term target by FY2032



#### Indigenous partnerships

Record Indigenous procurement spend  
**US\$609m**  
up 82% on FY2022



#### Healthy environment

Area under nature-positive management practices<sup>1</sup>  
**83k hectares**  
up 3,295 hectares since FY2022



#### Thriving, empowered communities

Total economic contribution<sup>2</sup>  
**US\$49.2bn**  
We contributed US\$41.5 bn to suppliers, community and social investments, employees and governments during the year. This was 84% of our total economic contribution.

1. For more information on the metrics and our nature-related goals and targets refer to CDP 10.10

2. For more information on the metrics and our nature-related goals and targets refer to CDP 10.10

3. For more information on our total economic contribution, refer to the 2023 Investor Presentation Report slide

For personal use only

For personal use only



## Chair's review

Dear Shareholders,

I am pleased to provide BHP's Annual Report for FY2024.

Our operational and financial performance was strong in FY2024, and we made solid progress against our social value and sustainability commitments. It is more than four years since we began the strategic transformation of BHP's portfolio towards future-facing commodities and the world has changed markedly in that time. Thank you for the trust you have given us through this period.

Today, BHP has a portfolio of world-class assets focused on products that are critical to the future. A portfolio positioned for growth, yet resilient and able to withstand volatility. A product mix that can continue to deliver financial and social value over the long term.

However, FY2024 was overshadowed by a fatality. We are deeply saddened that Luke O'Brien, a team member working with one of our contracting partners at BHP Mitsubishi Alliance (BMA), was fatally injured in January in a vehicle incident at the Saraji mine in Queensland. Our heartfelt thoughts and condolences go to Luke's family and friends. Safety is our top priority and our commitment to zero fatalities and serious injuries at BHP is unwavering.

### Our strategic priorities

During FY2024 I had the pleasure of meeting with our people, Indigenous partners, suppliers and other stakeholders at our global sites and offices. These discussions reinforced that our ongoing commitment to the priorities of safety, culture and capability, capital discipline, the continued development of our world-class portfolio and social value continue to be the right focus areas for BHP.

#### Safe, inclusive and productive workplaces

Our commitment to safety includes eliminating sexual harassment, racism and bullying in our workplaces. We are determined to eliminate these unequivocally unacceptable behaviours.

We know diverse and inclusive teams are safer and more productive. We achieved a 1.9 percentage point year-on-year increase in female employee participation in FY2024 to 37.1 per cent by year end. We also made progress towards our Indigenous employment targets, including Indigenous employee participation reaching 10.1 per cent in Chile and 11.2 per cent in Canada by year end. We have more work to do, but we are making progress on our commitment to provide a safe and inclusive workplace culture.

### Positioned for success

BHP, and mining, have a clear and undeniable role to provide the metals and minerals the world needs for more sustainable development.

The global trends shaping our future are interconnected, unstoppable and bring with them new challenges and opportunities for our sector. A growing and increasingly urbanised population seeking a higher standard of living will require vast amounts of metals and minerals. That demand will only be amplified by the energy transition.

We are continuing to position our portfolio to align with these trends. Iron ore for steel to build cities and renewables infrastructure, steelmaking coal for the blast furnace process for making steel, copper for electrification, nickel for electric vehicle batteries and potash for food security and more sustainable land.

### Delivering value

BHP's strong operational performance and disciplined approach to capital allocation has seen the Board determine dividends totaling US\$7.4 billion to shareholders for the year. This will take the total amount of cash dividends returned to you since 1 July 2021 to over US\$42 billion including the FY2024 final dividend.

We continued to make significant contributions to the communities where we operate through employment, community partnerships, payments to local suppliers, and taxes and royalties paid to governments. Our total global economic contribution was US\$49.2 billion in FY2024.

Creating social value is vital to our business and goes hand in hand with long-term sustainable shareholder value. In FY2024, we delivered tangible progress in each of the six pillars of our social framework which are focused on decarbonisation, the environment, Indigenous partnerships, workforce, communities, and supply chains. Social value is interwoven into our strategic decision-making through our social value framework, which helps us to meet the world's demand for resources more sustainably, with more renewable energy, less fresh water use and less disruption.

Our social value highlights in FY2024 included the completion of all our FY2024 Australian Reconciliation Action Plan targets and reforms, US\$137 million in voluntary social investment including community and environmental initiatives and continued progress towards reducing our operational greenhouse gas emissions.

Our Climate Transition Action Plan 2024 provides an update on our climate change strategy and our progress and plans in relation to our greenhouse gas emissions goals and targets. Our plan shows we are serious about addressing the impacts of climate change from our business while continuing to provide strong shareholder returns. At the Annual General Meeting this year there will be a ‘Say on climate’ vote and I recommend you vote in favour of our Climate Transition Action Plan 2024.

### **Board updates**

Our structured Board renewal process continued in FY2024. Ross McEwan joined the Board as a Non-executive Director on 3 April 2024. Ross has significant experience in the financial services industry with deep expertise in capital allocation, risk management and value creation in complex regulatory environments. Don Lindsay also joined the Board as a Non-executive Director on 1 May 2024 and brings over 40 years of global experience in the resources sector and investment banking, including in mining and resource development, financial markets, growth and value creation. In April 2024, Ian Cockerill retired from the Board and in October 2023, Terry Bowen also retired from the Board. We benefited greatly from Ian’s and Terry’s extensive experience and I would like to thank them for their contribution and commitment to BHP during their time with us.

### **Outlook**

In recent decades, we have seen global economies and supply chains come together and support sustained economic development. Today, we are seeing more turbulence, tension and polarisation in the geopolitical landscape. We expect economic conditions to remain challenging in FY2025 as geopolitical issues continue to create volatility and impact global markets, security and trade.

Despite these challenges, I am optimistic about our future.

We have a world-class portfolio of large, long-life and high-quality assets which stands to benefit from the global changes shaping our world. We have a clear focus on being the best operator in the resources sector, being disciplined in capital management through our Capital Allocation Framework and having a differentiated approach to creating social value. We have a culture that is committed to safety, productivity and continuous improvement and we are working to make our workforce more inclusive and diverse.

I am confident BHP is well positioned to continue to create sustainable long-term value for shareholders and for our partners and stakeholders in the year ahead.

Thank you for your continued support.

/s/ Ken MacKenzie

**Ken MacKenzie**

Chair

## Chief Executive Officer's review

Dear Shareholders,

At BHP, we work to bring people and resources together to build a better world, and we continued to make solid progress on this in FY2024.

The tragic loss of a coworker at Saraji in January in a light vehicle incident underscored why safety must remain our first priority. Following an investigation, we have identified improvement areas for Saraji and BMA and work is underway to implement these. We must eliminate fatalities and serious injuries at our operations.

It was a year of strong overall business performance at BHP. By executing our strategy, we outperformed our competitors in key areas. We achieved an annual production record at Western Australia Iron Ore (WAIO), where we also widened our lead as the world's lowest-cost iron ore producer. We delivered record production at copper assets Spence and Carrapateena, and the highest copper production in four years at Escondida – the world's largest copper mine. We will distribute dividends totaling 146 US cents per share for the year.

### Poised for growth

We continued to advance growth options in the commodities the world needs to meet the demands of the energy transition and population growth. We believe we have the balance sheet, technical and operational capability that will be needed to unlock new supply for the decades to come.

Construction of our Jansen potash project in Canada is ahead of the original schedule and first production is expected in just over two years. We have approved Jansen Stage 2, which will make BHP one of the leading players in the global potash industry by the end of the decade.

We have strengthened our position in copper. The integration of Prominent Hill and Carrapateena with Olympic Dam has delivered greater-than-expected synergies. We are exploring options to grow Copper South Australia's production beyond 500 kilotonnes per annum (ktpa) of copper, with further potential up to 650 ktpa. In July 2024, we increased our early-stage copper options by agreeing to acquire a 50 per cent interest in the Filo del Sol and Josemaria projects with Lundin Mining in Argentina and Chile. If approved, this will give us the opportunity to advance one of the most significant copper discoveries globally in recent decades.

Our project pipeline and focus on continuous improvement in existing operations leave us well poised for growth across our four commodity pillars of copper, potash, iron ore and steelmaking coal in the decades ahead.

### Winning strategy

Our actions in FY2024 are consistent with our winning strategy, founded on the three strategic pillars of safety and sustainability, exceptional performance and winning portfolio. In a cyclical industry, the stability of our operations and financial performance reflects the resilience and durability of our business.

The creation of social value is integral to our strategy and the delivery of long-term shareholder value. When we create social value, we build our case as the preferred partner for communities, we gain access to more opportunities, and we attract the best talent.

In the financial year, we increased Indigenous employment globally and boosted supplier spend with Indigenous businesses by 83 per cent to more than US\$600 million. This was part of a broader 9 per cent increase to US\$3.3 billion in supplier spend by BHP-operated businesses to more than 2,600 small, local and Indigenous businesses. This not only benefits our operations, but provides crucial support for jobs, businesses and families in regional communities surrounding them.

We made further progress on our operational decarbonisation plans and remain on track to meet our operational GHG emissions target of at least a 30 per cent reduction by FY2030 against an FY2020 baseline.

### Refining our portfolio

We continue to focus on building a portfolio of world-class assets in attractive commodities in stable jurisdictions.

We refined our steelmaking coal portfolio in Queensland with the sale of the Daunia and Blackwater mines by our joint venture BMA. This strategic shift positions BMA well for the forecasted strong demand for higher-quality steelmaking coal. Following the transaction, around 90 per cent of our steelmaking coals are high-grade products attracting premium pricing.

In July 2024, we made the difficult but necessary decision to transition Western Australia Nickel into a period of temporary suspension. This reflected significant global oversupply of nickel, which we expect will continue until the end of the decade. We have offered redeployment to all frontline workers in other parts of BHP and will continue to support impacted host communities in a range of ways, including through our A\$20 million Community Fund. We will continue to invest approximately US\$300 million per annum in our Western Australia Nickel facilities to enable a potential re-start if the global nickel market outlook improves. We will review the decision by February 2027.

### Our people and culture differentiate us

Our strong performance in FY2024 is a testament to our more than 90,000 employees and contractors who work hard to build a better BHP every day. They are empowered to do so by the BHP Operating System and we continue to build an inclusive and diverse culture with a performance edge.



During the year we refreshed Our Values, which set the tone for our culture. Our Values comprise three simple statements. First and foremost, we must always ‘Do what’s right’ – operating safely and with integrity are non-negotiable. We also need to constantly ‘Seek better ways’ – listening to others, seeking out new ideas, and improving on today. And finally, we must always strive to ‘Make a difference’, which applies not only to the company and the team, but also to the individual. Every day we have the opportunity to have a positive impact on performance, those around us, and the world. Our Values help guide everything we do at BHP. They reflect both what we stand for and who we aspire to be.

### **Innovation and technology**

BHP is well placed to capitalise on the opportunities afforded by artificial intelligence (AI) and advanced data analytics given our large-scale, repeatable operations and processes, and vast amounts of data. We are already starting to see benefits. The application of AI at our Escondida processing plants has helped save more than three gigalitres of water – and 118-gigawatt hours of energy – since FY2022. Machine learning has assisted in the discovery of new copper deposits in Australia and the United States.

Through our Xplor and BHP Ventures programs we continue to seek new partnerships and access to game-changing technologies and insight to help drive sustainable growth for the decades ahead.

### **In great shape**

BHP finished FY2024 in an excellent position. We are well placed to benefit from the significant global changes happening around us. We have strategic clarity and exposure to the right commodities. We continue to build on our excellence in operations and discipline in our capital allocation.

We hold resilient, long-term assets with substantial optionality. This allows us to make smart choices about how and where we use our balance sheet to fund growth and generate value.

As we look to FY2025, we will continue to execute our strategy to create value for our shareholders, community partners and stakeholders, now and into the future.

Thank you for your continued support.

/s/ Mike Henry

**Mike Henry**

Chief Executive Officer

# 1 Why BHP

## Our strategy

We will responsibly manage the most resilient long-term portfolio of assets, in highly attractive commodities, and will grow value through being excellent at operations, discovering and developing resources, acquiring the right assets and options, and capital allocation.

Through our differentiated approach to social value, we will be a trusted partner who creates value for all stakeholders.

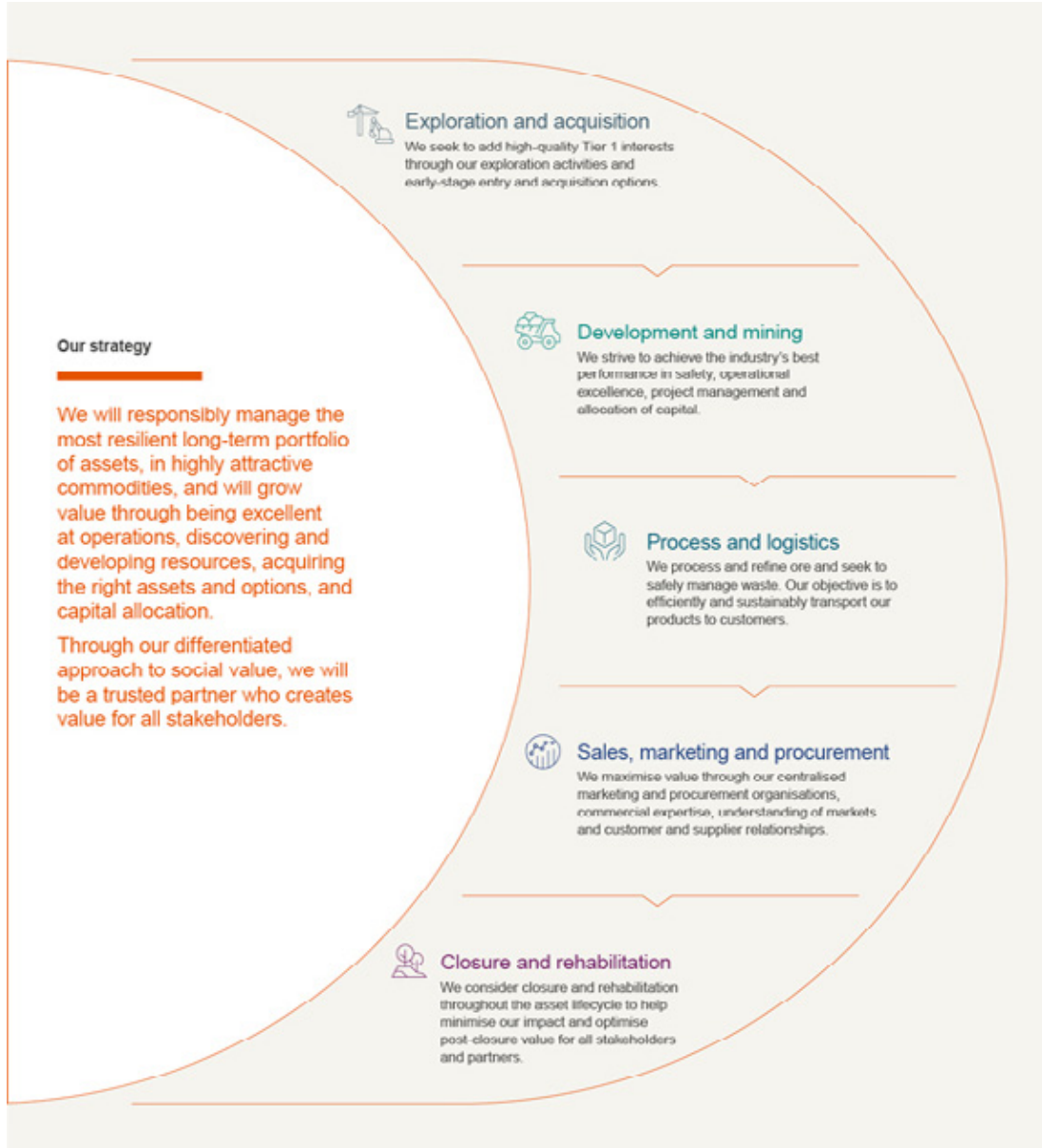

The world needs essential metals and minerals to be produced by companies who set and uphold high ESG standards, who run their operations safely and efficiently, and who allocate capital in a consistent and disciplined way. These are the companies that will succeed. This is BHP.

Our capabilities, track record, scale and the unique way we work through the BHP Operating System enable a culture of continuous improvement.

We aim to grow value for our shareholders, partners and stakeholders through our portfolio of large long-life quality assets in attractive commodities and through our focus on social value, which is integral to how we operate.

BHP is positioned to benefit from the changes shaping our planet now and for decades to come as demand for our commodities grows.

## Our products are vital

Population growth, urbanisation and improving living standards are global trends that underpin strong demand for the commodities we produce.

Demand for essential commodities is expected to increase as the world seeks to decarbonise.

Iron ore is needed for making steel to build cities and renewables infrastructure. Steelmaking coal is needed for the blast furnace process for making steel. Copper is vital for electrification. Nickel can be used in electric vehicle batteries. Potash can help with food security and more sustainable land use.

## Scale is important

As new large low-cost ore bodies become harder to find and develop, the scale and quality of our assets set us apart. We have some of the largest resources and lowest-cost assets in the world.

One of our biggest growth levers is productivity and unlocking more value from our existing assets. We seek to improve productivity through the capabilities of our people and culture of continuous improvement driven through the BHP Operating System, and the use of technology and innovation to extract more from what we do every day and more from our resources.

The scale of our assets provides multiple growth options. We are seeking to produce more iron ore in Western Australia. We are working to improve productivity at our steelmaking coal operations in Queensland. We are advancing multiple growth options in copper in Chile and our recently established copper province in South Australia. We have sanctioned the second stage of our Jansen potash project in Canada, which will eventually double its expected annual production.

>[For more information refer to OFR 5](#)

### **Social value is embedded in everything we do**

We are committed to social value: our positive contribution to society. It is vital for our future and a consideration in the strategic decisions we make.

Social value underpins stable operations, reduces risk and opens doors to opportunities, partnerships, talent and capital. Delivering social value will help us to continue to generate long-term value for all partners and stakeholders, including shareholders.

>[For more information refer to OFR 6.2 to 6.5](#)

### **We do what we say**

BHP has a track record of doing what we say we will do. We continue to plan strategically, responsibly, consistently, with a clear focus on being the best operator, being disciplined in capital allocation and continuing to generate value and returns for stakeholders.

We have generated net operating cash flows of over US\$15 billion for all but one of the past 15 years. This stability is our hallmark – achieved through robust capital management and consistent operational performance.

Including the final dividend for FY2024 declared, we will have distributed more than US\$42 billion in total in cash dividends to shareholders since 1 July 2021. This includes US\$7.4 billion in cash dividends for FY2024.

Our total economic contribution in FY2024 was US\$49.2 billion. This includes contributions to suppliers, wages and benefits for more than 90,000 employees and contractors, dividends, taxes and royalties, and voluntary investment in projects in the communities where we operate.

>[For more information refer to OFR 4 and the BHP Economic Contribution Report 2024 available at \[bhp.com/ECR2024\]\(https://bhp.com/ECR2024\)](#)

### **The future is clear**

Key commodities we produce or are positioning to produce are vital for a better world and can help address global challenges, such as climate change and food security.

We are continuing to build an inclusive and diverse workforce of talented people. We have a strong balance sheet and industry-leading operational capability underpinned by the BHP Operating System and our technical Centres of Excellence.

Our track record, long-term stability and commitment to social value and sustainability set us apart.

This combination will help us achieve our aim of growing value more consistently for our partners and stakeholders and drive attractive returns and long-term value for our shareholders.

## 1.1 Where we operate

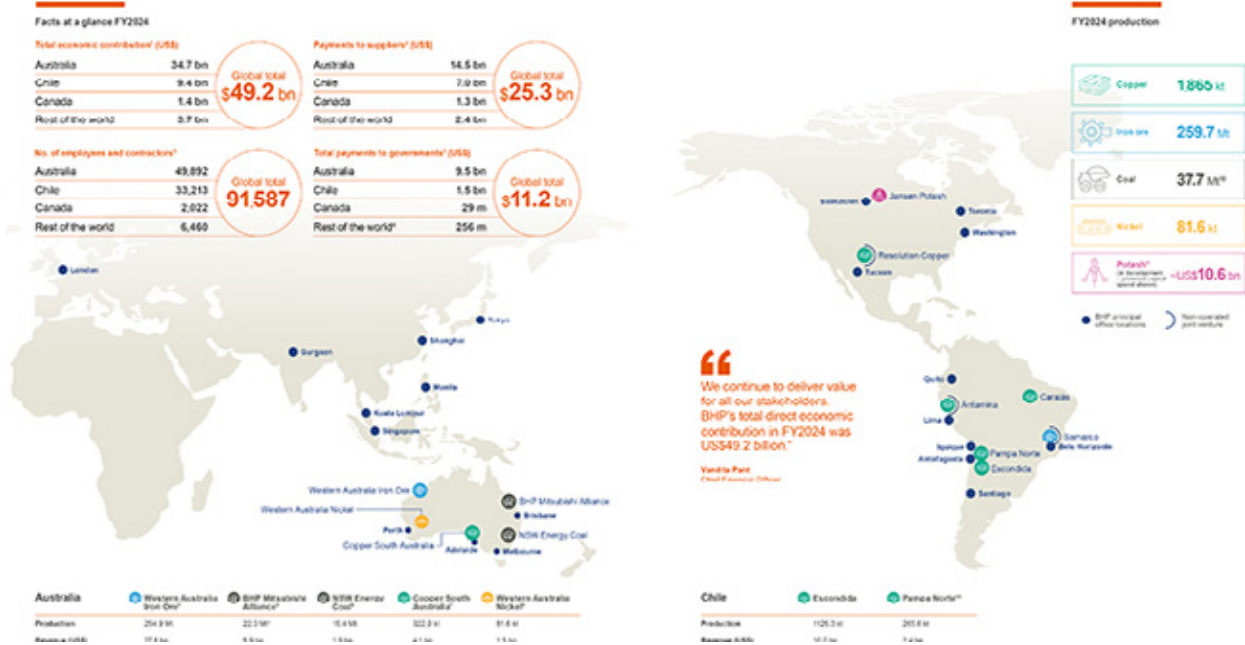

### Footnotes

1. This includes contribution to suppliers, wages and benefits for employees and contractors, dividends, taxes and royalties, and voluntary social investment. For more information refer to the Economic Contribution Report 2024.
2. For more information refer to the Economic Contribution Report 2024.
3. Based on a ‘point-in-time’ snapshot of employees as at 30 June 2024, including employees on extended absence. Contractor data is collected from internal organisation systems and averaged for a 10-month period, July 2023 to April 2024. Figures reported do not include employees and contractors of BHP Mitsubishi Alliance Blackwater and Daunia operations, sold to Whitehaven Coal during FY2024, and employees and contractors of the operations in Brazil that were acquired as part of the OZ Minerals acquisition completed during FY2023.
4. Rest of the world includes consolidation adjustments related to intra-group transactions.
5. Shown on a BHP share basis.
6. Includes Newcastle Coal Infrastructure Group (NCIG), which is an equity accounted investment and its financial information presented above, with the exception of net operating assets, reflects BHP Group’s share. Total Coal statutory result excludes contribution related to NCIG until future profits exceed accumulated losses.
7. Includes Olympic Dam, Prominent Hill and Carrapateena.
8. Includes Nickel West and West Musgrave project.
9. Reflects the contribution of the Blackwater and Daunia mines to 2 April 2024, the date on which BMA’s owners completed its divestment.
10. BHP’s attributable coal production for the year, being 50 per cent of BMA’s steelmaking coal production (22.3 Mt) and 100 per cent of New South Wales Energy Coal production (15.4 Mt).
11. In October 2023, BHP approved US\$4.9 billion in capital expenditure for Jansen Stage 2. First potash production from Jansen Stage 1, which has approved capital expenditure of US\$5.7 billion, is expected in late CY2026.
12. Includes Spence and Cerro Colorado.

## 1.2 Our portfolio

A resource mix for today – and for the future

We have copper, which is used in electrification. Iron ore, which is essential for making steel needed for construction, including renewables infrastructure. Our higher-quality steelmaking coal is used in the blast furnace process for making steel. Nickel can be used in electric vehicle batteries. We are on track to be a major global producer of potash by the end of the decade. Potash is used in fertilisers to assist with food security for a growing population and more sustainable land use. Among our by-products, we are a major producer of uranium and gold.

### Copper

Highest production in over 15 years

**1.86 Mt**

<sup>^</sup>9% on FY2023

We hold the world's largest copper mineral resources.<sup>1</sup> We are using technical innovation, such as new flotation technology, to help lower energy costs and unlock value. We continue to pursue our strategy to increase our exposure to future-facing commodities, including copper, through exploration, acquisition and early-stage options. Our copper production rose 9 per cent in FY2024 to the highest in more than 15 years.

Escondida in Chile is the world's largest copper mine. It increased production by 7 per cent in FY2024 compared to FY2023, to 1.12 million tonnes (Mt) (100 per cent basis). This was primarily due to a higher concentrator feed grade as mining progressed into areas of higher-grade ore as planned following the implementation of measures to manage geotechnical events in FY2023. Spence in Chile delivered another year of record production, up 6 per cent to 255 kilotonnes (kt). We are exploring a range of growth options across our Chilean copper assets, including a potential new concentrator at Escondida and the application of leaching technologies at Spence and Cerro Colorado.

We have established a significant resource base at Copper South Australia by adding Olympic Dam with Carrapateena and Prominent Hill from our OZ Minerals acquisition in FY2023. The successful integration of the former OZ Minerals assets has delivered increased production and exceeded our annualised synergies planned at the time of the acquisition of OZ Minerals. This has been through actions such as the processing of Prominent Hill and Carrapateena concentrate at Olympic Dam into higher-margin cathode and refined gold, resulting in annual records for cathode and gold production at Olympic Dam. Copper South Australia production was 322 kt in FY2024, including record production at Carrapateena. We're progressing growth options at Copper South Australia, where our aspiration is to grow copper production to beyond 500 kt per year. Given the gold, silver and uranium co-products, this would be equivalent to over 700 kt per annum copper equivalent. We had exploration success in South Australia in FY2024 with OD Deeps, delivering greater than two kilometres in strike and more than one kilometre in depth at over 1 per cent copper grade and an Inferred Mineral Resource declaration at Oak Dam.

In July 2024, we agreed to acquire a 50 per cent interest in the Filo del Sol and Josemaria copper projects in Argentina and Chile with Lundin Mining. If approved, this will give us the opportunity to jointly advance an emerging copper district with world-class potential.

**>For more information refer to OFR 5.2 and 5.3**

### Iron ore

Second-consecutive full-year production record

**260 Mt**

<sup>^</sup>1% on FY2023

Western Australia Iron Ore (WAIO) is the lowest-cost major iron ore producer globally<sup>2</sup> and has one of the lowest greenhouse gas (GHG) emission production intensities of benchmarked iron ore operations.<sup>3</sup>

WAIO delivered a second-consecutive full-year production record of 287 Mt (255 Mt BHP share), reflecting strong supply chain performance with increased capacity unlocked by the Port Debottlenecking Project 1 and increased production from South Flank, our newest and most technologically advanced mine. These more than offset the impacts of the continued tie-in activity for the Rail Technology Programme 1. South Flank ramped up to full production capacity of 80 million tonnes per annum (Mtpa) (100 per cent basis) on schedule during FY2024.

We continue to invest in improvements in our rail and port operations and are assessing options to grow our WAIO production up to 330 Mtpa if market conditions warrant. These options include optimal mine and infrastructure configurations and potentially increased ore beneficiation. We expect to complete these studies in CY2025.

**>For more information refer to OFR 5.1**

### **Steelmaking coal**

Focusing on higher-quality product

**22.3 Mt**

↓ 23% on FY2023

We continue to focus our steelmaking coal operations in Queensland on higher-quality product and have one of the lowest GHG emission production intensities of benchmarked export steelmaking coal mines.<sup>3</sup> In a challenging year for BMA, production decreased from the prior year as a result of increased stripping to improve supply chain stability and restore depleted inventory positions, which arose from extended weather impacts and labour constraints over recent years, and the divestment of Blackwater and Daunia on 2 April 2024.

We believe a wholesale shift away from the blast furnace process for steelmaking is decades in the future. We also believe higher-quality steelmaking coals have potential for greater upside for quality premiums. This is because we believe steelmakers will seek to operate their blast furnaces with stronger, higher-performance steelmaking coal to lower overall coal consumption and, over time, to improve blast furnace process performance when implementing future GHG emission reduction technologies.

On 2 April 2024, BHP and its joint venture partner, Mitsubishi Development Pty Ltd, completed the sale of the Blackwater and Daunia mines to Whitehaven Coal for up to US\$4.1 billion (100 per cent basis). Following the sale, around 90 per cent of BMA's products will be sold by reference to the Platts PLV HCC FOB Qld index, the highest quality steelmaking coal index, up from 64 per cent prior to the transaction.

**>For more information refer to OFR 5.1**

### **Nickel**

Temporary suspension announced

**81.6 kt**

^2% on FY2023

Nickel West production in FY2024 was in line with the prior year.

On 11 July 2024, we announced Western Australia Nickel, comprising the Nickel West operations and West Musgrave project, would be temporarily suspended from October 2024. We intend to review this decision by February 2027.

The decision to temporarily suspend Western Australia Nickel reflects oversupply in the global nickel market. Forward consensus nickel prices over the next half of the decade have fallen sharply reflecting strong growth of alternative low-cost nickel supply.

During the temporary suspension, BHP will continue to support our workforce and local communities. BHP will invest approximately US\$300 million per annum following completion of a transition period to support a potential re-start of Western Australia Nickel. The transition period commenced in July 2024. Operations will be suspended in October 2024 and handover activities for temporary suspension are expected to be completed by December 2024.

**>For more information refer to OFR 5.1**

## Potash

Major global producer by the end of the decade

### US\$10.6bn

Total approved capital expenditure through Jansen Stage 1 and Jansen Stage 2

We are developing one of the world's largest potash mines in Canada. The Jansen potash project will increase our product diversification, customer base and operating footprint, and expand our business into a future growth market.

The US\$5.7 billion Jansen Stage 1 project is ahead of the original schedule and was over 50 per cent complete by the end of FY2024. First production from Jansen Stage 1 is expected in late CY2026, followed by a two-year ramp-up period. In October 2023, we announced an additional investment of US\$4.9 billion for Jansen Stage 2, which will increase Jansen's total planned potash production capacity to ~8.5 Mtpa. We have commenced execution of Jansen Stage 2.

Transitioning directly from Jansen Stage 1 to Jansen Stage 2 during the construction period will bring operational benefits, including leveraging the experience of our integrated project team and continued use of our existing suppliers and contractors.

We are on track to be a major global producer of potash by the end of the decade. Longer term, Jansen has the potential for two additional expansions to reach an ultimate production capacity of 16 to 17 Mtpa (subject to studies and approvals).

>[For more information refer to OFR 5.3](#)

## Footnotes

1. Largest copper mineral resources on a contained metal basis, equity share. Peers include: Anglo American, Antofagasta, Codelco, First Quantum Minerals, Freeport, Glencore, Rio Tinto, Southern Copper and Teck. Source peers: Wood Mackenzie Ltd, Q2 2023. Source BHP data: BHP Annual Report 2024.
2. Based on published unit costs of major iron ore producers as reported at 30 June 2024. There may be differences in the manner that third parties calculate or report unit costs data compared to BHP, which means third-party data may not be comparable with our data.
3. For CY2023, the GHG emissions intensity of our production of our commodities is estimated to rank in the first quartile for our iron ore, copper and steelmaking coal mines, and the second quartile for our nickel operations (ahead of all Indonesian-based operations) of global mining operations analysed by CRU. This analysis is based on CY2023 data from CRU (as CRU data is prepared on a calendar year basis), and includes CRU's assumptions and estimates of BHP's operations. We transitioned to using CRU (rather than Skarn Associates) for this analysis in FY2024 as part of an annual vendor assessment and selection process. For more information on how the GHG emission intensity for our iron ore and steelmaking coal mines has been calculated and compared refer to the BHP ESG Standards and Databook 2024 available at [bhp.com/climate](https://bhp.com/climate).

## 2 What differentiates us

BHP's ability to deliver differentiates us from our competitors. We do what we say we will do. This has created stability in our historical performance that has been a hallmark of BHP for more than a decade.

There are many factors that underpin this historic stability, each of which is vital. It's the unique combination of these factors that sets us apart.

### Our people

We have more than 90,000 employees and contractors globally. We strive to offer an engaging and supportive workplace, which empowers our people to find safer and more productive ways of working. We do this by providing the tools and opportunities in our working environment to allow our people to perform at their best. Our people are empowered daily in their work by the BHP Operating System.

## Our Values

Our Values set the tone for our culture, a unique part of our competitive advantage. They are a declaration of what we stand for. They guide our decision-making, reinforce our culture and ensure all our people are steering in the same direction, delivering on our purpose.

In FY2024, Our Values were refreshed to:

Do what's right – A sustainable future starts with safety and integrity, building trust with those around us

Seek better ways – Listening to learn and inspiring challenge is how we drive progress

Make a difference – The accountability to act, create value and have impact is on each of us, every day

Our Values help our people move quickly and deliberately when we encounter challenges and opportunities.

## Health and safety



>For more information refer to OFR 6.1 and 6.8

## Female employee participation

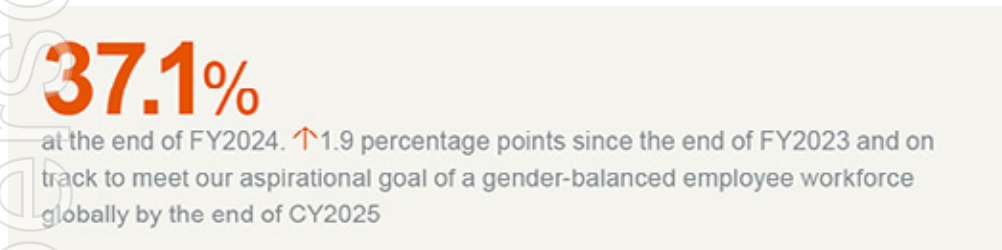

## Indigenous employee participation<sup>2</sup>



## Footnotes

1. Combined employee and contractor frequency per 1 million hours worked.
2. Point in time data at 30 June 2024.
3. Participation in Minerals Australia operations in Australia. FY2023 figure does not include OZ Minerals.
4. Participation in Minerals Americas operations in Chile.
5. Participation in Jansen potash project and operation employees in Canada.



## BHP Operating System

The BHP Operating System (BOS) is our unique overarching management system that enables the right culture, routines, behaviours and leadership to deliver stable operating excellence and leading safety performance. It provides us with a competitive edge.

BOS drives continuous improvement through the application of BOS tools and practices. It makes improvement central to everyone's role, allowing people to work on the system, not just in it.

BOS helps us continuously focus on leadership development, capability and engagement, and creates better-planned, more stable work processes.

Aligning around our strategy, operating philosophy and principles for decision-making will make us an even better company – one that focuses on safety, leads the sector, generates strong returns for our shareholders, and meets the expectations of our partners, communities and other stakeholders.

We have deployed BOS across our business.

### How BOS works

Three principles underpin BOS and guide how we think and behave at BHP



### Exceptional performance

#### Operating and financial strength

The strength of our portfolio, our operating excellence and financial rigour from our disciplined application of the Capital Allocation Framework (CAF) enables us to deliver strong and consistent returns. We achieved net operating cash flow of US\$20.7 billion in FY2024. Our net operating cash flow has been more than US\$15 billion for all but one of the past 15 years.

In FY2024, through our CAF, we kept our balance sheet strong, delivered growth and returns for our shareholders, made progress towards our social value and GHG emission reduction objectives and prioritised capital to maintain reliable operations.

#### Operational excellence

Our strong results in FY2024 were driven by performance and discipline at our operations, which overall performed well. We achieved production guidance across all commodities in FY2024, with steelmaking coal achieving the upper end of its revised production guidance. This included record annual production at WAIO, Spence and Carrapateena, record cathode and gold production at Olympic Dam, and the highest production in four years at Escondida.

Our focus on cost discipline helped us manage inflationary pressures effectively. We experienced a global inflation rate of around 4 per cent, particularly in relation to labour. Our cost discipline allowed us to mitigate these ongoing cost pressures with unit costs around 2.9 per cent higher across our major assets. We met unit cost guidance at Escondida, WAIO and Spence, and revised unit cost guidance at BMA. WAIO extended its lead over competitors as the lowest cost major iron ore producer globally.

For mining companies, cost differentiation is becoming even more pronounced. General inflation and labour are expected to continue to put upwards pressure on costs. The costs of decarbonisation are also expected to be inflationary and will disproportionately impact companies with higher GHG emissions intensity. As such, while the marginal cost of mining production is clearly higher than in the past; in the medium term there are signs it could go higher.

### Technology and innovation

The use of technology and our focus on innovation, together with BOS, have helped accelerate continuous improvement – from the introduction of advanced technologies designed to improve safety and increase productivity of our operated assets, to reducing water and energy consumption.

Technology is a key lever for BHP and has been used to:

- support the maintenance of safe, predictable and productive operations
- drive productivity improvements, with an emphasis on automation and real-time, data-driven insights and decision-making
- unlock the next stage of value growth potential, such as by realising greater margins at our existing operations and enabling the discovery of new assets
- improve sustainability outcomes through innovation
- help drive inclusion and diversity, such as remote operations and decision support tools that make roles more accessible to a wider range of people

The advanced use of next generation technologies, such as artificial intelligence (AI) and cloud and data analytics, are supporting quicker and more efficient resource recovery, more safely and more sustainably. They are also helping lift performance through operational improvements.

Examples of how BHP used AI in FY2024 include:

- A digital tool at Escondida used AI to increase revenue by US\$18.9 million in FY2024 by enabling drill and blast teams to select a more optimal blasting pattern design. The technology also helps to mitigate coarse ore restrictions at Escondida's semi-autogenous grinding (SAG) mills by improving post-blasting fragmentation. We will use this tool at Spence to assist with stabilising its SAG mill performance and increase its productivity.
- Next generation improvements to the Process Area Set Point Optimisation (PASPO) were rolled out across BMA sites in FY2024 to increase production of on-specification steelmaking coal, increasing revenue by US\$15.5 million. For example, the Caval Ridge team identified an opportunity to increase yield by reducing density variation while keeping train product ash on specification.

We upgraded our global technology system 1SAP ERP to S/4HANA in FY2024. The modernisation of this core global platform is critical to our operations, as it is used to:

- pay our people and suppliers
- sell and deliver our products
- better maintain our equipment
- accurately report our financial results to the market
- above all, enable us to operate more safely, efficiently and reliably

### Social value

We are committed to social value and sustainability and are making progress in more responsibly providing commodities the world needs to develop and decarbonise. We believe this commitment can help us become a partner of choice with communities, governments, suppliers and our customers. We seek to be a valued partner with the communities where we operate and the Indigenous peoples we interact with.

In FY2024, we continued to refine our approach to social value. We have provided progress on our 2030 goals through our 2030 social value scorecard.

**>For more information on our 2030 social value scorecard refer to OFR 6.5**

Through our commitment to sustainability, we seek to reduce the impact of our operational activities. We have set a long-term goal to achieve net zero operational GHG emissions (Scopes 1 and 2 emissions from our operated assets) by CY2050. We also have a long-term goal of net zero Scope 3 GHG emissions by CY2050. Achievement of this Scope 3 goal is uncertain, particularly given the challenges of a net zero pathway for our customers in steelmaking, and we cannot ensure the outcome alone.

We manage our operational decarbonisation projects across our operated assets through our CAF to help us use our capital effectively.

We are also working with our suppliers and customers to support their efforts to reduce GHG emissions. For example, during FY2024 we signed a framework agreement with Rio Tinto and BlueScope to investigate the development of an ironmaking electric smelting furnace pilot plant using Pilbara iron ores that have been pre-processed into direct reduced iron. This process route could open a pathway to an alternative to the conventional blast furnace method of steelmaking with the potential to reduce GHG emissions intensity by 85 per cent and meet near zero emission steelmaking benchmarks.<sup>1</sup>

**For more information on our GHG emission goals and targets refer to OFR 6.9**

We have set goals in areas such as environment and water stewardship. To meet the FY2024 short-term milestone for the Healthy environment pillar of our social value scorecard, we have developed a Group-level framework for nature-positive plans to achieve our 2030 Healthy environment goal (BHP Healthy environment goal roadmap).<sup>2</sup> Our 2030 Healthy environment goal is to create nature-positive<sup>3</sup> outcomes by having at least 30 per cent of the land and water we steward<sup>4</sup> at the end of FY2030 under conservation, restoration or regenerative practices.

At 30 June 2024, we had 83,012 hectares or 1.62 per cent<sup>5</sup> of the land and water we steward<sup>4,6</sup> under nature-positive management practices.<sup>7</sup>

**>For more information refer to OFR 6.5**

**Financial excellence**

We use our Capital Allocation Framework (CAF) to assess the most effective and efficient way to deploy capital. Since the CAF's introduction in FY2016, we have balanced reinvestment in our business with cash returns to shareholders.

Our CAF promotes discipline in all capital decisions.



**Footnotes**

1. Based on direct reduced iron electric smelting furnace route (using renewable or other low to zero GHG emissions power). Estimated reduction in GHG emissions intensity is calculated relative to a baseline reference of 2.2 tonnes of CO<sub>2</sub>-e per tonne of crude steel, as sourced from IEA Iron and Steel Technology Roadmap (October 2020). For more information refer to our Value chain GHG emissions – Hydrogen reduction and electric smelting of BHP ores case study on page 26 of our Climate Transition Action Plan 2024, available at [bhp.com/CTAP2024](http://bhp.com/CTAP2024).
2. The BHP Healthy environment goal roadmap is intended to apply to our operated assets in Australia, Chile and Canada. Due to the acquisition of OZ Minerals and prioritisation of activities based on risks and impacts, Carrapateena, Prominent Hill, West Musgrave and legacy assets are currently out of scope for the roadmap; with the exception of West Musgrave, these assets are planned to be incorporated into the roadmap in FY2025. Incorporation of West Musgrave into the BHP Healthy environment goal roadmap will be reviewed following the decision to temporarily suspend the Western Australia Nickel operations.
3. Nature-positive is defined by the TNFD Glossary version 1.0 as 'A high-level goal and concept describing a future state of nature (e.g. biodiversity, ecosystem services and natural capital), which is greater than the current state'. We understand it includes land and water management practices that halt and reverse nature loss – that is, supporting healthy, functioning ecosystems. BHP intends to review this definition in FY2025, in light of the recently revised TNFD Glossary version 2.0 (June 2024) definition of nature-positive.
4. This excludes areas we hold under greenfield exploration licences (or equivalent tenements), which are outside the area of influence of our existing mine operations. 30 per cent will be calculated based on the areas of land and water that we steward at the end of FY2030.
5. 1.62 per cent is calculated based on the areas of land and water that we stewarded (excluding areas we hold under greenfield exploration licences (or equivalent tenements) and subject to footnote 6) at 30 June 2024 – which was approximately 5,125,935 hectares; an increase of approximately 18,750 hectares compared to approximately 5,107,185 hectares at 30 June 2023. For more information on the restatement of FY023 figures refer to OFR 6.10.
6. While some of the land related to the Daunia and Blackwater mines is pending transfer following BMA's divestment of these mines on 2 April 2024, these areas are no longer under BMA's control or operated for BMA's benefit so have been excluded from the areas of land and water we stewarded at 30 June 2024.
7. Nature-positive management practices refer to an area under stewardship that has a formal management plan that includes conservation, restoration or regenerative practices. For more information refer to the BHP ESG Standards and Databook 2024, available at [bhp.com/ESGStandards2024](http://bhp.com/ESGStandards2024).

### 3 Positioning for growth

With our clear strategy and our laser-like focus on creating and sustaining the right portfolio of the best assets in attractive commodities with enhanced growth optionality, BHP is well placed to capitalise on the changes shaping our world. As the global population grows and urbanises and the world pursues decarbonisation and electrification, we are positioning our portfolio and pursuing multiple growth options to increase our exposure to these megatrends.

#### Unlocking growth at our assets

One of our biggest near-term growth levers is from improving productivity at our existing assets and unlocking more of their potential.

WAIO was designed with an initial capacity of 240 Mtpa. In FY2024, it produced a record 287 Mt (100 per cent basis). We are implementing initiatives to grow WAIO production to more than 305 Mtpa over the medium term. This is expected to be through South Flank, which reached full production capacity in FY2024, the continued debottlenecking of our port and rail systems, the rollout of autonomous haulage trucks, and ongoing productivity enhancements. We are studying options to further grow annual production up to 330 Mt over the medium to long term, with these studies expected to be completed in CY2025.

Escondida has significant resource potential and we are progressing a range of studies, including potentially replacing the original Los Colorados concentrator. We are also looking at different leaching technologies that could help us extract more copper while potentially using less energy and water, reduce or eliminate the need for tailings dams, and enable production of cathode-finished product that does not require smelting.

#### Growing our position in potash

Potash is a fertiliser and enables more efficient and sustainable farming. With the world's population continuing to grow and rising concerns around food security and land use, potash is a future-facing commodity that presents opportunities for growth.

At the end of FY2024, Jansen Stage 1 was tracking ahead of the original schedule and more than 50 per cent complete. Production is expected to commence in late CY2026, followed by a two-year ramp-up period. When Jansen Stage 1 reaches full production, planned production will be approximately 4.15 Mtpa.

During FY2024, BHP approved Jansen Stage 2, which will double planned production to around 8.5 Mtpa at full capacity. Jansen Stage 2 is an important milestone that underscores our confidence in potash and marks the next phase of BHP's growth in Canada. We believe Jansen will deliver long-term value for shareholders and the local community, and will position BHP as one of the leaders in the global potash industry. We have commenced execution of Jansen Stage 2, with first production expected in FY2029.

#### Copper South Australia: Consolidating a significant resource base

We have established a significant resource base at Copper South Australia by combining OZ Minerals' two South Australian mines, Prominent Hill and Carrapateena, with Olympic Dam and the Oak Dam deposit.

With Copper South Australia, we are focused on developing an asset with greater scale and simplicity. Copper South Australia produced 322 kt of copper in FY2024 and we are pursuing potential pathways to expand this to more than 500 kilotonnes per annum (ktpa) through increases in mine production rates and improved mining methods, the expansion of smelting and refining capacity, the application of BOS, the development of exploration assets and greater by-product production.

Exploration efforts progressed at the Oak Dam copper deposit located 65 kilometres southeast of Olympic Dam and at OD Deeps, which is below Olympic Dam. The Copper South Australia province is expected to produce copper, gold and uranium oxide for decades to come.

**>For more information refer to OFR 5.2**

#### Creating and accelerating longer-term options

##### BHP Ventures

BHP Ventures is our dedicated venture capital unit. It looks for game-changing technologies via emerging companies to help drive ongoing and more sustainable growth within BHP and provides us with a portfolio of new growth options for the decades ahead.

BHP Ventures complements the innovation already underway within BHP by forging new partnerships and creating fresh opportunities to strengthen our portfolio and support the decarbonisation of our operated assets and decarbonisation opportunities in our value chain. For our partners, BHP Ventures provides an opportunity to collaborate with us.

New investments in FY2024 included SiTration, which is developing a silicon membrane-based technology for metal extraction, and ZwitterCo, which is developing membrane solutions for the treatment of water. BHP continued to support existing portfolio companies Boston Metal and Electra through technical knowledge exchanges and the supply of iron ores for testing in relation to technologies that have potential to contribute to our Scope 3 emissions medium-term goal for steelmaking and our long-term net zero goal. BHP also continued to test early-stage leaching technologies from Jeti Resources and Ceibo as part of broader copper leaching studies.

#### Think & Act Differently

Think & Act Differently is BHP's internal team set up to find and accelerate the best mining technology solutions to support our ambitions to deliver commodities the world needs in new ways. It is focused on opening new and accelerated pathways to market through partnerships, rapid experimentation and systems thinking. It aims to de-risk a portfolio of over 100 initiatives, from small scale experiments to on-site demonstrations.

We are seeking to advance technologies that can unlock resource growth, particularly relating to copper, and build capability across the mining value chain to find new ways to understand ore bodies and responsibly extract and process resources. Current areas of work include leaching, ore body knowledge and accelerated minerals recovery.



### BHP Exploration

During FY2024, we advanced our global programs focusing on early-stage exploration opportunities in Australia, Canada, Chile, Peru, Sweden, Serbia and the United States. This effort involved concept evaluation work through prospect testing.

We fully integrated the OZ Minerals exploration portfolio, significantly expanding our land holdings and enabling us to develop an important province in South Australia with significant copper potential.

In Canada, we continued our partnership with Midland Exploration Inc. through our prospect generation exploration alliance.

In the United States, we entered an alliance with Ivanhoe Electric Inc., with BHP to provide initial funding of US\$15 million over three years to explore for copper and other critical minerals across areas of interest in Arizona, New Mexico and Utah.

In Australia, we commenced a partnership with Red Ox Copper Pty Ltd, exploring for copper in Northern Queensland.

In Europe, we acquired Ragnar Metals Sweden AB for A\$9.8 million, gaining ownership of the Tullsta nickel project. Similarly, we entered into early-stage exploration alliances with Kingsrose Mining Ltd across areas of interest in Finland and Norway, and with Tutume Metals in Botswana.

Also in FY2024, we withdrew from the Elliott Farm-in and joint venture agreement with Encounter Resources Limited in Australia.

### Growth through exploration, focused on copper and nickel

#### BHP Xplor

BHP Xplor, launched in FY2023, is a global accelerator program designed to support early-stage mineral exploration companies in finding critical resources needed for the energy transition. Its aim is to identify and nurture the next generation of explorers, empowering them to fast track their geologic concepts for potential long-term partnership. The program supports technical, business and operational facets to equip participant companies with the necessary tools and guidance to become investment ready.

To date, agreements have been concluded with three companies from the inaugural FY2023 cohort for follow-on investment, due to their region of interest, potential technical opportunity, team capability and strategic alignment.

In FY2024, six companies were chosen from a pool of over 500 applications to take part in this year's program. These companies were East Star Resources Plc, Hamelin Gold Ltd, Pallas Resources Ltd, Longreach Mineral Exploration Pty Ltd, Equivest Metals Oy and Cobre Ltd. They have concluded their six-month program and follow-on investment discussions have started. Applications for the FY2025 Xplor program opened in August 2024.

## Exploration expenditure

Our resource assessment exploration expenditure increased by 31 per cent in FY2024 to US\$333 million, while our greenfield expenditure increased by 31 per cent to US\$124 million. Expenditure on resources assessment and greenfield exploration over the last three financial years is set out below.

<b>Year ended 30 June</b>	<b>2024</b>	<b>2023</b>	<b>2022</b>
	<b>US\$M</b>	<b>US\$M</b>	<b>US\$M</b>
Greenfield exploration	124	95	77
Resources assessment	333	255	179
<b>Total metals exploration and assessment</b>	<b>457</b>	<b>350</b>	<b>256</b>

## Exploration expense

Exploration expense represents that portion of exploration expenditure that is not capitalised in accordance with our accounting policies, as set out in Financial Statements note 11 'Property, plant and equipment'.

Exploration expense for each segment over the last three financial years is set out below.

<b>Year ended 30 June</b>	<b>2024</b>	<b>2023</b>	<b>2022</b>
	<b>US\$M</b>	<b>US\$M</b>	<b>US\$M</b>
<b>Exploration expense</b>			
Copper	213	145	85
Iron Ore	41	52	54
Coal	3	6	6
Group and unallocated items <sup>1,2</sup>	152	91	54
<b>Total Group</b>	<b>409</b>	<b>294</b>	<b>199</b>

1. Group and unallocated items includes functions, other unallocated operations including Potash, Western Australia Nickel (which comprises the Nickel West operations and, following the OZ Minerals Ltd (OZL) acquisition on 2 May 2023, the West Musgrave project), legacy assets and consolidation adjustments.

2. Includes US\$10 million of exploration expenditure previously capitalised, written off as impaired (included in depreciation and amortisation) (FY2023: US\$ nil; FY2022: US\$ nil).

## Chief Financial Officer's review

Not required for US reporting.

## 4 Financial review

### 4.1 Group overview

We prepare our Consolidated Financial Statements in accordance with International Financial Reporting Standards (IFRS), as issued by the International Accounting Standards Board. We publish our Consolidated Financial Statements in US dollars. All Consolidated Income Statement, Consolidated Balance Sheet and Consolidated Cash Flow Statement information below has been derived from audited Consolidated Financial Statements.

#### >For more information refer to Financial Statements

We use various non-IFRS financial information to reflect our underlying performance. Non-IFRS financial information is not defined or specified under the requirements of IFRS, however is derived from the Group's Consolidated Financial Statements prepared in accordance with IFRS. Non-IFRS financial information is consistent with how management reviews financial performance of the Group with the Board and the investment community. OFR 10 'Non-IFRS financial information' includes our non-IFRS financial information and OFR 10.1 'Definition and calculation of non-IFRS financial information' outlines why we believe non-IFRS financial information is useful and the relevant calculation methodology. We believe non-IFRS financial information provides useful information, however it should not be considered as an indication of, or as a substitute for, statutory measures as an indicator of actual operating performance (such as profit or net operating cash flow) or any other measure of financial performance or position presented in accordance with IFRS, or as a measure of a company's profitability, liquidity or financial position.

### Summary of financial measures

#### Year ended 30 June

US\$M	2024	2023
<b>Consolidated Income Statement (Financial Statements 1.1)</b>		
Revenue	55,658	53,817
Profit/(loss) after taxation from Continuing operations	9,601	14,324
Profit/(loss) after taxation from Continuing and Discontinued operations attributable to BHP shareholders	7,897	12,921
Dividends per ordinary share – paid during the period (US cents)	152.0	265.0
Dividends per ordinary share – determined in respect of the period (US cents)	146.0	170.0
Basic earnings/(loss) per ordinary share (US cents)	155.8	255.2
<b>Consolidated Balance Sheet (Financial Statements 1.3)</b>		
Total assets	102,362	101,296
Net assets	49,120	48,530
<b>Consolidated Cash Flow Statement (Financial Statements 1.4)</b>		
Net operating cash flows	20,665	18,701
Capital and exploration and evaluation expenditure	9,273	7,083
<b>Other financial information (OFR 10)</b>		
Net debt	9,120	11,166
Underlying attributable profit	13,660	13,420
Underlying EBITDA	29,016	27,956
Underlying basic earnings per share (US cents)	269.5	265.0
Underlying return on capital employed (per cent)	27.2	28.8

### 4.2 Key performance indicators

Our key performance indicators (KPIs) enable us to measure our development and financial performance. These KPIs are used to assess performance of our people throughout the Group.

#### >For information on our approach to performance and reward refer to Remuneration Report

#### >For information on our overall approach to executive remuneration, including remuneration policies and remuneration outcomes refer to Remuneration Report

Following BHP's sale of the Onshore US assets in FY2019 and subsequently the merger of our Petroleum business with Woodside in FY2022, the contribution of these assets to the Group's results is presented as Discontinued operations. Footnotes to tables and infographics indicate whether data presented in OFR 4.2 is inclusive or exclusive of Petroleum assets. Details of the contribution of the Petroleum assets to the Group's results are disclosed in Financial Statements note 28 'Discontinued operations'.

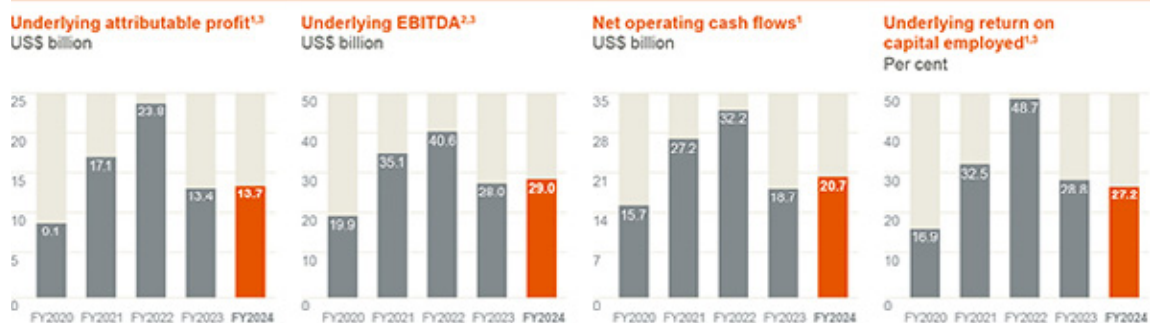

- Includes data for Continuing and Discontinued operations for the financial years being reported.
- Excludes data from Discontinued operations for the financial years being reported.
- For more information on non-IFRS financial information refer to OFR 10.

## Reconciling our financial results to our key performance indicators

Measure	Profit		Earnings		Cash		Returns	
		US\$M		US\$M		US\$M		US\$M
	<b>Profit after taxation from Continuing and Discontinued operations</b>	<b>9,601</b>	<b>Profit after taxation from Continuing and Discontinued operations</b>	<b>9,601</b>	<b>Net operating cash flows from Continuing operations</b>	<b>20,665</b>	<b>Profit after taxation from Continuing and Discontinued operations</b>	<b>9,601</b>
<b>Made up of</b>	Profit after taxation		Profit after taxation		Cash generated by the Group's consolidated operations, after dividends received, interest, proceeds and settlements of cash management related instruments, taxation and royalty-related taxation. It excludes cash flows relating to investing and financing activities.		Profit after taxation	
<b>Adjusted for</b>	Exceptional items before taxation	<b>6,600</b>	Exceptional items before taxation	<b>6,600</b>			Exceptional items after taxation	<b>5,763</b>
	Tax effect of exceptional items	<b>(837)</b>	Tax effect of exceptional items	<b>(837)</b>			Net finance costs excluding exceptional items	<b>983</b>
	Exceptional items after tax attributable to non-controlling interests	<b>-</b>	Depreciation and amortisation excluding exceptional items	<b>5,295</b>			Income tax expense on net finance costs	<b>(303)</b>
	Exceptional items attributable to BHP shareholders	<b>5,763</b>	Impairments of property, plant and equipment, financial assets and intangibles excluding exceptional items	<b>90</b>			Profit after taxation excluding net finance costs and exceptional items	<b>16,044</b>
	Profit after taxation attributable to non-controlling interests	<b>(1,704)</b>	Net finance costs excluding exceptional items	<b>983</b>			Net Assets at the beginning of period	<b>48,530</b>
			Taxation expense excluding exceptional items	<b>7,284</b>			Net Debt at the beginning of period	<b>11,166</b>
							Capital employed at the beginning of period	<b>59,696</b>
							Net Assets at the end of period	<b>49,120</b>
							Net Debt at the end of period	<b>9,120</b>
							Capital employed at the end of period	<b>58,240</b>
							Average capital employed	<b>58,968</b>
<b>To reach our KPIs</b>	<b>Underlying attributable profit</b>	<b>13,660</b>	<b>Underlying EBITDA</b>	<b>29,016</b>	<b>Net operating cash flows</b>	<b>20,665</b>	<b>Underlying return on capital employed</b>	<b>27.2%</b>
<b>Why do we use it?</b>	Underlying attributable profit allows the comparability of underlying financial performance by excluding the impacts of exceptional items.		Underlying EBITDA is used to help assess current operational profitability excluding the impacts of sunk costs (i.e. depreciation from initial investment). It is a measure that management uses internally to assess the performance of the Group's segments and make decisions on the allocation of resources.		Net operating cash flows provide insights into how we are managing costs and increasing productivity across BHP.		Underlying return on capital employed is an indicator of the Group's capital efficiency. It is provided on an underlying basis to allow comparability of underlying financial performance by excluding the impacts of exceptional items.	



### 4.3 Financial results

The following table provides more information on the revenue and expenses of the Group in FY2024.

Year ended 30 June	2024 US\$M	2023 US\$M	2022 US\$M
<b>Continuing operations</b>			
Revenue <sup>1</sup>	55,658	53,817	65,098
Other income	1,285	394	1,398
Expenses excluding net finance costs	(36,750)	(31,873)	(32,371)
(Loss)/profit from equity accounted investments, related impairments and expenses	(2,656)	594	(19)
<b>Profit from operations</b>	<b>17,537</b>	<b>22,932</b>	<b>34,106</b>
Net finance costs	(1,489)	(1,531)	(969)
Total taxation expense	(6,447)	(7,077)	(10,737)
<b>Profit after taxation from Continuing operations</b>	<b>9,601</b>	<b>14,324</b>	<b>22,400</b>
<b>Discontinued operations</b>			
Profit/(loss) after taxation from Discontinued operations	–	–	10,655
<b>Profit after taxation from Continuing and Discontinued operations</b>	<b>9,601</b>	<b>14,324</b>	<b>33,055</b>
Attributable to non-controlling interests	1,704	1,403	2,155
Attributable to BHP shareholders	7,897	12,921	30,900

1. Includes the sale of third-party products.

Profit after taxation attributable to BHP shareholders decreased from US\$12.9 billion in FY2023 to US\$7.9 billion in FY2024. Attributable profit of US\$7.9 billion includes an exceptional loss of US\$5.8 billion (after tax), compared to an Attributable profit of US\$12.9 billion, including an exceptional loss of US\$0.5 billion (after tax) in the prior period. The FY2024 exceptional loss includes a US\$2.7 billion non-cash (after tax) impairment at Western Australia Nickel (WAN) due to oversupply in the global nickel market that has seen a sharp decline in forward nickel prices in the short to medium term, escalation in capital costs, and changes to development plans including the Group's decision, announced on 11 July 2024, to temporarily suspend Nickel West operations and the West Musgrave project at WAN. The FY2024 exceptional loss also includes US\$3.8 billion (after tax) relating to Samarco dam failure impacts, partially offset by the gain on divestment of Blackwater and Daunia coal assets of US\$0.7 billion (after tax).

#### >For more information on Exceptional items refer to Financial Statements note 3 'Exceptional items'

Revenue of US\$55.7 billion increased by US\$1.8 billion, or 3 per cent from FY2023. This increase was mainly due to higher average realised prices for iron ore and copper combined with higher sales volumes, partially offset by lower average realised prices for thermal coal and nickel.

Higher sales volumes were achieved at WAIO supported by record production reflecting strong supply chain performance, at Copper SA from the successful integration of OZ Minerals (OZL) following the acquisition in FY2023, at Escondida due to higher concentrator feed grade and at New South Wales Energy Coal (NSWEC) from improved weather and labour availability. These were partially offset by lower sales volumes at BMA as a result of increased stripping to improve supply chain stability and restore depleted inventory positions which arose from extended weather impacts and labour constraints over recent years, and the divestment of Blackwater and Daunia on 2 April 2024.

#### >For information on our average realised prices and production of our commodities refer to OFR 9

Other income of US\$1.3 billion increased by US\$0.9 billion, or 226 per cent from FY2023 primarily due to the divestment of Blackwater and Daunia.

Total expenses excluding net finance costs of US\$36.8 billion increased by US\$4.9 billion, or 15 per cent from FY2023. This primarily reflected a higher impairment expense of US\$3.8 billion of WAN due to the deterioration in the short and medium-term outlook for nickel. Higher external contractor services expenses of US\$1.0 billion was mainly due to the full-year contribution of Prominent Hill and Carrapateena since their acquisition in FY2023, impacts of inflation across the Group, additional tailings work at Spence, higher maintenance at Escondida and higher stripping and contractor costs in line with higher volumes at NSWEC.

Loss from equity accounted investments, related impairments and expenses of US\$2.7 billion increased by US\$3.3 billion from a profit of US\$0.6 billion in FY2023 predominantly reflects the change in the assessment of the estimated costs to resolve all aspects of the Federal Public Prosecution Office Claim and the Framework Agreement obligations.

#### >For more information on the total impact of the Samarco dam failure provision and impairment charges connected with equity accounted investments refer to Financial Statements note 3 'Exceptional items' and Financial Statements note 13 'Impairment of non-current assets' respectively

Net finance costs of US\$1.5 billion were in line with FY2023 primarily driven by higher market interest rates, offset by a reduction in closure and rehabilitation provision discounting due to lower global inflation rates and higher capitalised interest mainly at Potash.

#### >For more information on net finance costs refer to Financial Statements note 23 'Net finance costs'

Total taxation expense of US\$6.4 billion decreased by US\$0.6 billion, or 9 per cent from FY2023 primarily due to a tax benefit of US\$1.1 billion in relation to the impairment of WAN partially offset by higher tax in line with higher profits from higher average realised prices.

#### >For more information on income tax expense refer to Financial Statements note 6 'Income tax expense'

## Principal factors that affect Underlying EBITDA

The following table and commentary describe the impact of the principal factors<sup>1</sup> that affected Underlying EBITDA for FY2024 compared with FY2023.

	US\$M	
<b>Year ended 30 June 2023</b>	<b>27,956</b>	
Net price impact:		
Change in sales prices	<b>1,476</b>	Higher average realised prices for iron ore and copper partially offset by lower average realised prices for thermal coal and nickel.
Price-linked costs	<b>108</b>	Lower coal and nickel royalties largely offset by higher iron ore royalties in line with price movements.
	<b>1,584</b>	
Change in volumes	<b>10</b>	Higher sales volumes were achieved at WAIO supported by record production reflecting strong supply chain performance including record production at South Flank following ramp up to full capacity in FY2024, at Escondida due to higher concentrator feed grade and at NSWEC from improved weather and labour availability. These were offset by lower sales volumes at BMA as a result of increased stripping to improve supply chain stability and restore depleted inventory positions, which arose from extended weather impacts and labour constraints over recent years.
Change in controllable cash costs		
Operating cash costs	<b>(655)</b>	Higher costs at WAIO primarily as we ramped up South Flank and increased production, at NSWEC from higher stripping and contractor costs to support higher production, at Escondida reflecting higher maintenance and at WAN due to increased third-party ore purchases following delivery issues in FY2023.
Exploration and business development	<b>(118)</b>	Higher exploration spend for drilling activities at Oak Dam at Copper SA.
	<b>(773)</b>	
Change in other costs:		
Exchange rates	<b>253</b>	Impact of movements in the Australian dollar and Chilean peso against the US dollar.
Inflation	<b>(686)</b>	Impact of inflation on the Group's cost base.
Fuel, energy, and consumable price movements	<b>487</b>	Predominantly lower diesel and acid prices.
Non-cash	<b>(301)</b>	
One-off items	<b>316</b>	Primarily non recurrence of FY2023 review of employee allowances and entitlements, and OZL acquisition costs.
	<b>69</b>	
Ceased and sold operations	<b>(510)</b>	Lower contribution from the Blackwater and Daunia mines related to divestment in April 2024.
New and acquired operations	<b>528</b>	At Copper SA from the successful integration of OZL following the acquisition in FY2023.
Other items	<b>152</b>	Includes increased profit from Antamina driven by higher average copper realised prices and VAT refund received in relation to previously divested Petroleum operations.
<b>Year ended 30 June 2024</b>	<b>29,016</b>	

1. For information on the method of calculation of the principal factors that affect Underlying EBITDA refer to OFR 10.2.

## Cash flow

The following table provides a summary of the Consolidated Cash Flow Statement contained in Financial Statements 1.4, excluding the impact of foreign currency exchange rate changes on cash and cash equivalents.

Year ended 30 June	2024 US\$M	2023 US\$M	2022 US\$M
Net operating cash flows from Continuing operations	20,665	18,701	29,285
Net operating cash flows from Discontinued operations	–	–	2,889
<b>Net operating cash flows</b>	<b>20,665</b>	<b>18,701</b>	<b>32,174</b>
Net investing cash flows from Continuing operations	(8,762)	(13,065)	(4,973)
Net investing cash flows from Discontinued operations	–	–	(904)
Net cash completion payment on merger of Petroleum with Woodside	–	–	(683)
Cash and cash equivalents disposed on merger of Petroleum with Woodside	–	–	(399)
<b>Net investing cash flows</b>	<b>(8,762)</b>	<b>(13,065)</b>	<b>(6,959)</b>
Net financing cash flows from Continuing operations	(11,669)	(10,315)	(22,734)
Net financing cash flows from Discontinued operations	–	–	(33)
<b>Net financing cash flows</b>	<b>(11,669)</b>	<b>(10,315)</b>	<b>(22,767)</b>
<b>Net increase/(decrease) in cash and cash equivalents</b>	<b>234</b>	<b>(4,679)</b>	<b>2,448</b>
Net increase/(decrease) in cash and cash equivalents from Continuing operations	234	(4,679)	1,578
Net increase in cash and cash equivalents from Discontinued operations	–	–	1,952
Net cash completion payment on merger of Petroleum with Woodside	–	–	(683)
Cash and cash equivalents disposed on merger of Petroleum with Woodside	–	–	(399)

**Net operating cash inflows from Continuing operations** of US\$20.7 billion increased by US\$2.0 billion. This is primarily due to lower tax and royalty related taxation finalisation payments in FY2024 relating to FY2023 profits, compared to payments in FY2023 relating to FY2022 profits.

**Net investing cash outflows from Continuing operations** of US\$8.8 billion decreased by US\$4.3 billion. This decrease primarily reflects the non-recurrence of the US\$5.9 billion acquisition of OZL completed in FY2023 in conjunction with the proceeds received in FY2024 related to the divestment of BHP's interest in Blackwater and Daunia coal operations to Whitehaven Coal of US\$1.1 billion, partially offset by higher capital expenditure of US\$2.1 billion including for Jansen and West Musgrave.

**>For more information on exceptional items relating to the divestment of Blackwater and Daunia and a breakdown of capital and exploration expenditure on a commodity basis refer to Financial Statements note 3 'Exceptional items' and OFR 9 respectively.**

**Net financing cash outflows from Continuing operations** of US\$11.7 billion increased by US\$1.4 billion. This increase reflects a net movement in repayments/proceeds of interest bearing liabilities of US\$7.1 billion mainly due to the repayment of the OZL acquisition facility in FY2024 (US\$5.0 billion) and higher other bond issuances compared to FY2023. These were partially offset by lower dividends paid to BHP shareholders of US\$5.6 billion.

**>For more information refer to Financial Statements note 21 'Net debt'**

**Underlying return on capital employed (ROCE)** of 27.2 per cent decreased by 1.6 percentage points (FY2023: 19.9 percentage point decrease) reflecting an increase in average capital employed attributable to the impact of the OZL acquisition in FY2023. Reductions in capital employed related to the impairment of WAN and the divestment of Blackwater and Daunia are largely offset by capital expenditure in the period.

**>For more information on ROCE refer to OFR 10**

## Prior year comparatives

The comparisons for the year ended 30 June 2023 to 30 June 2022 in connection with Financial results, Principal factors that affect Underlying EBITDA and Cash flow have been omitted from this annual report on Form 20-F and can be found in our annual report on Form 20-F for the fiscal year ended 30 June 2023, filed on 5 September 2023.

## 4.4 Debt and sources of liquidity

Our policies on debt and liquidity management have the following objectives:

- a strong balance sheet through the cycle
- diversification of funding sources
- maintain borrowings and excess cash predominantly in US dollars

### Interest bearing liabilities, net debt and gearing

At the end of FY2024, Interest bearing liabilities were US\$20.7 billion (FY2023: US\$22.3 billion) and Cash and cash equivalents were US\$12.5 billion (FY2023: US\$12.4 billion). This resulted in Net debt of US\$9.1 billion, which represented a decrease of US\$2.0 billion compared with the Net debt position at 30 June 2023. The reduction is primarily due to US\$20.7 billion operating cash flows generated combined with US\$1.1 billion proceeds from the divestment of the Blackwater and Daunia mines, which were partially offset by capital and exploration expenditure of US\$9.3 billion and dividend payments of US\$9.1 billion. Gearing, which is the ratio of Net debt to Net debt plus Net assets, was 15.7 per cent at 30 June 2024, compared with 18.7 per cent at 30 June 2023.

**>For more information on Net debt and gearing refer to Financial Statements note 21 'Net debt' and OFR 10**

During FY2024, gross debt decreased by US\$1.6 billion to US\$20.7 billion as at 30 June 2024. The decrease reflects the repayment of the US\$5.0 billion OZL acquisition facility in September 2023 combined with the repayment of US\$734 million of 3.85 per cent USD senior notes that matured in September 2023 and €560 million of EUR senior notes that matured in May 2024, largely offset by the issuance of US\$4.75 billion of US bonds in September 2023.

At the subsidiary level, Escondida repaid US\$0.3 billion of debt and received proceeds from debt of US\$0.4 billion in the period.

#### Funding sources

In September 2023, the Group issued five tranches of USD bonds comprising US\$850 million 5.25 per cent bonds due CY2026, US\$700 million 5.1 per cent bonds due CY2028, US\$900 million 5.25 per cent bonds due CY2030, US\$1.5 billion 5.25 per cent bonds due CY2033 and US\$800 million 5.5 per cent bonds due CY2053. The USD bonds were issued by BHP Billiton Finance (USA) Limited, a wholly-owned finance subsidiary of BHP Group Limited, and are fully and unconditionally guaranteed by BHP Group Limited.

Our Group-level borrowing facilities are not subject to financial covenants. Certain specific financing facilities in relation to specific assets are the subject of financial covenants that vary from facility to facility, but this would be considered normal for such facilities.

In addition to the Group's uncommitted debt issuance programs, we hold the following committed standby facility:

	Facility available 2024 US\$M	Drawn 2024 US\$M	Undrawn 2024 US\$M	Facility available 2023 US\$M	Drawn 2023 US\$M	Undrawn 2023 US\$M
Revolving credit facility <sup>1</sup>	5,500	–	5,500	5,500	–	5,500
<b>Total financing facility</b>	<b>5,500</b>	<b>–</b>	<b>5,500</b>	<b>5,500</b>	<b>–</b>	<b>5,500</b>

- The facility is due to mature on 10 October 2026. The committed US\$5.5 billion revolving credit facility operates as a back-stop to the Group's uncommitted commercial paper program. The combined amount drawn under the facility or as commercial paper will not exceed US\$5.5 billion. As at 30 June 2024, US\$ nil commercial paper was drawn (FY2023: US\$ nil), therefore US\$5.5 billion of committed facility was available to use (FY2023: US\$5.5 billion). A commitment fee is payable on the undrawn balance and interest is payable on any drawn balance comprising a reference rate plus a margin. The agreed margins are typical for a credit facility extended to a company with the Group's credit rating.

**>For more information on the maturity profile of our debt obligations and details of our standby and support agreements refer to Financial Statements note 24 'Financial risk management'**

**>Information in relation to our material off-balance sheet arrangements, principally contingent liabilities, commitments for capital expenditure and commitments under leases at 30 June 2024 is provided in Financial Statements note 11 'Property, plant and equipment', Financial Statements note 22 'Leases' and Financial Statements note 34 'Contingent liabilities', respectively**

In our opinion, working capital is sufficient for our present requirements. The Group's Moody's credit rating has remained at A1/P-1 outlook stable (long-term/short-term). The Group's S&P Global rating has remained at A-/A-1 outlook stable (long-term/short-term). Credit ratings are forward-looking opinions on credit risk. Moody's and S&P Global's credit ratings express the opinion of each agency on the ability and willingness of BHP to meet its financial obligations in full and on time. A credit rating is not a recommendation to buy, sell or hold securities and may be subject to suspension, reduction or withdrawal at any time by an assigning rating agency. Any credit rating should be evaluated independently of any other information.

The following table expands on the Net debt position, to provide more information on the cash and non-cash movements in FY2024.

<b>Year ended 30 June</b>	<b>2024</b>	<b>2023</b>
	<b>US\$M</b>	<b>US\$M</b>
<b>Net debt at the beginning of the period</b>	<b>(11,166)</b>	<b>(333)</b>
Net operating cash flows	20,665	18,701
Net investing cash flows	(8,762)	(13,065)
Net financing cash flows	(11,669)	(10,315)
<b>Net increase/(decrease) in cash and cash equivalents from Continuing and Discontinued operations</b>	<b>234</b>	<b>(4,679)</b>
<b>Carrying value of interest bearing liability net repayments/(proceeds)</b>	<b>2,236</b>	<b>(4,893)</b>
<b>Carrying value of debt related instruments settlements/(proceeds)</b>	<b>321</b>	<b>677</b>
<b>Carrying value of cash management related instruments (proceeds)/settlements</b>	<b>(361)</b>	<b>(331)</b>
Fair value change on hedged loans <sup>1</sup>	214	803
Fair value change on hedged derivatives <sup>1</sup>	(188)	(691)
Foreign currency exchange rate changes on cash and cash equivalents	(159)	(134)
Lease additions (excluding leases associated with index-linked freight contracts)	(429)	(472)
Acquisition of subsidiaries and operations <sup>2</sup>	–	(1,111)
Divestment of subsidiaries and operations <sup>3</sup>	60	–
Other	118	(2)
<b>Non-cash movements</b>	<b>(384)</b>	<b>(1,607)</b>
<b>Net debt at the end of the period</b>	<b>(9,120)</b>	<b>(11,166)</b>

1. The Group hedges against the volatility in both exchange and interest rates on debt, and also exchange rates on cash, with associated movements in derivatives reported in Other financial assets/liabilities as effective hedged derivatives (cross currency and interest rate swaps), in accordance with accounting standards. For more information refer to Financial Statements note 24 'Financial risk management'.

2. US\$1,111 million of Interest bearing liabilities were acquired on 2 May 2023 as part of the acquisition of OZL. Excludes US\$104 million cash acquired which is included in Net investing cash flows.

3. Relates to leases disposed of as part of the Blackwater and Daunia mines divestment completed on 2 April 2024. Refer to Financial Statements note 3 'Exceptional items' for further information.

#### **Dividends**

Our dividend policy provides for a minimum 50 per cent payout of Underlying attributable profit (Continuing operations) at every reporting period. The minimum dividend payment for the second half of FY2024 was US\$0.70 per share. The Board determined to pay an additional amount of US\$0.04 per share, taking the final dividend to US\$0.74 per share (US\$3.8 billion). In total, cash dividends of US\$7.4 billion (US\$1.46 per share) have been determined for FY2024.

#### **Prior year comparatives**

The comparison for the year ended 30 June 2023 to 30 June 2022 has been omitted from this annual report on Form 20-F and can be found in our annual report on Form 20-F for the fiscal year ended 30 June 2023, filed on 5 September 2023.

## 5 Our assets

### 5.1 Minerals Australia

Minerals Australia includes operated assets in Western Australia, Queensland and New South Wales, focused on iron ore, steelmaking coal, nickel and energy coal. The commodities produced by our Minerals Australia assets are transported by rail and road to port and exported to our global customers or by rail to domestic customers.

#### Iron ore

##### Western Australia Iron Ore



#### Overview

Western Australia Iron Ore (WAIO) is an integrated system of four processing hubs and five open-cut operational mines in the Pilbara region of northern Western Australia, connected by more than 1,000 kilometres of rail infrastructure and port facilities.

WAIO's Pilbara reserve base is relatively concentrated, allowing development through integrated mining hubs connected to the mines and satellite orebodies by conveyors or spur lines. This approach seeks to maximise the value of installed infrastructure by using the same processing plant and rail infrastructure for several orebodies.

Ore is crushed, beneficiated (where necessary) and blended at the processing hubs – Mt Newman operations (which has our beneficiation plant), Yandi, Mining Area C (our largest operating iron ore hub processing ore from Area C and South Flank) and Jimblebar – to create lump and fines products that are transported along the Port Hedland–Mt Newman rail line to the Finucane Island and Nelson Point port facilities at Port Hedland.

There are four main WAIO joint ventures (JVs): Mt Newman JV, Yandi JV, Mt Goldsworthy JV (which includes the South Flank mining area) and Jimblebar JV. BHP's interest in each is 85 per cent, with Mitsui and ITOCHU owning the remaining 15 per cent. The joint ventures are unincorporated, except Jimblebar JV.

BHP, along with Mitsui, ITOCHU and POSCO are also participants in the POSMAC JV. BHP's interest in POSMAC is 65 per cent. The ore from the POSMAC JV is sold to the Mt Goldsworthy JV.

All ore is transported on the Mt Newman JV and Mt Goldsworthy JV rail lines. The Nelson Point port facility is owned by the Mt Newman JV and the Finucane Island facility is owned by the Mt Goldsworthy JV. On 7 September 2021, BHP received regulatory approval to increase our export capacity at WAIO's Port Hedland operations, in stages, up to 330 million tonnes per annum (Mtpa) (100 per cent basis). We are currently studying expansion alternatives for growth up to 330 Mtpa with the feasibility study expected to be completed in CY2025.

Our near-term focus remains on stable production of 290 Mtpa of iron ore. Successful tie-in of capital projects, including the port debottlenecking project, is expected to enable growth in excess of 305 Mtpa in the medium term.

#### Key developments in FY2024

WAIO achieved record production of 255 million tonnes (Mt) (253 Mt FY2023) or 287 Mt (285 Mt FY2023) on a 100 per cent basis, reflecting strong supply chain performance with increased capacity unlocked by the Port Debottlenecking Project 1 and increased production at South Flank. South Flank completed ramp up to full production capacity of 80 Mtpa (100 per cent basis) in FY2024 as planned, which contributed to WAIO achieving record lump sales for the year.

Autonomous haulage deployment continues as planned.

The Shiploader Automation Project has continued to progress with the automation completed on two shiploaders and the third shiploader nearing completion. Together with autonomous haulage rollouts at South Flank and Newman West, these initiatives are expected to deliver safety, production and cost improvements as well as new job and development opportunities.

The Port Debottlenecking Project 1 was commissioned in December 2023 and has enabled higher production volumes and contributed to record sales volumes in FY2024. The project remains on track to be completed in CY2024.

In February 2024, BHP approved US\$943 million in capital expenditure for the development of the Western Ridge Crusher Project. This project is expected to deliver an average of 25 Mtpa providing around 12 years of product for WAIO to replace part of the production from depleting orebodies around Newman. First ore is targeted in CY2026.

In FY2024, WAIO achieved record spend with Traditional Owners and Indigenous businesses representing a 69 per cent increase on the previous year to A\$465 million of which A\$237 million was spent with 68 Traditional Owner businesses.

## Coal

### BHP Mitsubishi Alliance

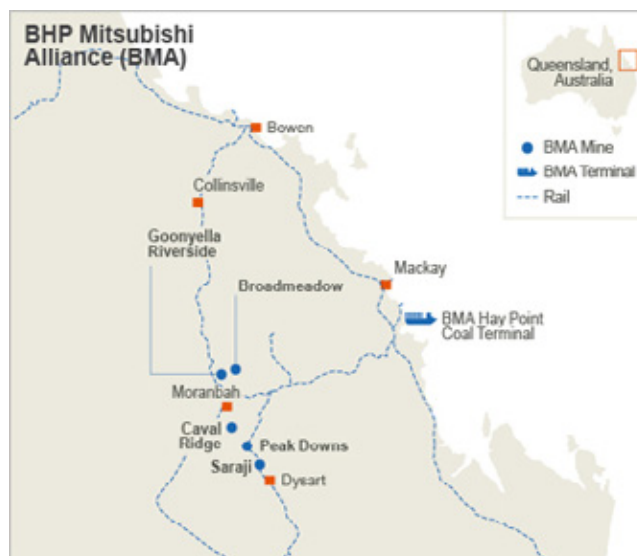

### Overview

BHP Mitsubishi Alliance (BMA) (BHP ownership: 50 per cent) operates five steelmaking coal mines – Goonyella Riverside, Broadmeadow, Peak Downs, Saraji and Caval Ridge in the Bowen Basin, Queensland. BMA’s mines are open cut, except for the Broadmeadow underground longwall operation. BMA has access to infrastructure, including a modern, multi-user rail network, and owns and operates its own coal-loading terminal at Hay Point, near Mackay.

### Key developments in FY2024

BMA production of 22.3 Mt (44.6 Mt on a 100 per cent basis) decreased from the prior year as a result of increased stripping to improve supply chain stability and restore depleted inventory positions, which arose from extended weather impacts and labour constraints over recent years, and the divestment of Blackwater and Daunia on 2 April 2024. Production was also impacted by an extended longwall move and geotechnical faulting at Broadmeadow during H1 FY2024, and the temporary suspension of operations following the fatality of a team member at Saraji. Blackwater and Daunia produced 5 Mt (10 Mt on a 100 per cent basis) in FY2024 prior to their divestment.

In April 2024, BMA’s owners, BHP and Mitsubishi Development, divested the Daunia and Blackwater mines to Whitehaven Coal, an ASX-listed company. Whitehaven Coal paid a combined US\$2.0 billion cash consideration on completion plus a preliminary completion adjustment of US\$44.1 million for working capital and other agreed adjustments (100 per cent interest basis). The total consideration for the transaction includes earnout and adjustments and may be up to US\$4.1 billion plus the final completion adjustment amount.

Goonyella continued to safely increase autonomous productivity and ultra-class truck fleet performance in FY2024 – delivering an annualised production hours increase of 7 per cent, contributing to a 6 per cent increase in truck and shovel stripping volumes at Goonyella Riverside, as we’ve continued to adapt and unlock the efficiencies of the system.

In October 2023, BMA successfully commissioned a replacement berth structure and shiploader at Hay Point Coal Terminal resulting in improved resilience for significant weather and major cyclone events and enabling the port’s future and long-term capability.

BMA operations largely lie within the Native Title Determination area of the Barada Barna people. BMA has been working closely with the Barada Barna Aboriginal Corporation (BBAC) to negotiate a project-wide Indigenous Land Use Agreement. The agreement was approved and signed by BBAC and BMA and is expected to be approved by the Queensland Government in early FY2025. This agreement demonstrates a refreshed approach to agreement structures and establishes a process to obtain and maintain Free Prior and Informed Consent (FPIC) across the life of the operation. It provides a fit-for-purpose benefits package intended to provide intergenerational benefit for Barada Barna people through financial compensation, provision of housing, as well as in the areas of employment, education and contracting opportunities.

## New South Wales Energy Coal

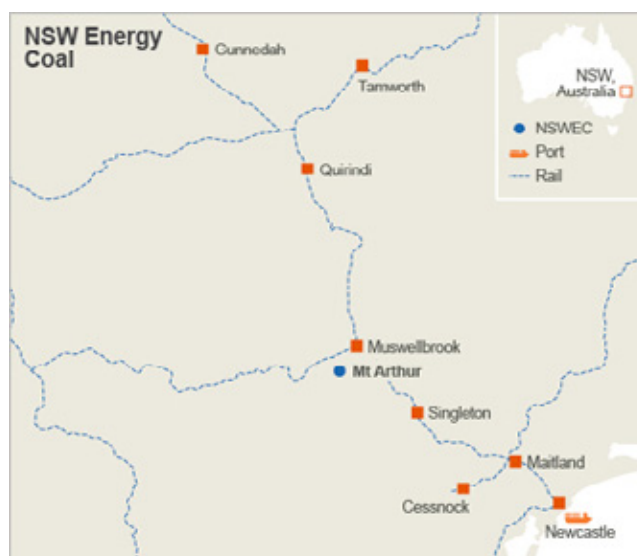

### Overview

New South Wales Energy Coal (NSWEC) (BHP ownership: 100 per cent) comprises the Mt Arthur Coal open-cut energy coal mine in the Hunter Valley. It has access to infrastructure in the Hunter Region, including a multi-user rail network and coal loading terminal access at the Port of Newcastle through Newcastle Coal Infrastructure Group (BHP ownership: 28 per cent) and Port Waratah Coal Services.

On 16 June 2022, we announced we would retain NSWEC in our portfolio, seek the relevant approvals to continue mining beyond the current consent that expires at the end of FY2026 and proceed with a managed process to cease mining at the asset by the end of FY2030. Continuation of mining to the end of FY2030 is intended to provide the time to work with our people and the local community on an equitable change and transition approach as well as the time to plan and execute the necessary works to deliver a positive legacy from BHP mining in the Hunter Valley.

### Key developments in FY2024

Production increased due to strong operating performance across the year as improved weather and labour availability conditions enabled an uplift in truck productivity and record annualised truck hours. We also supported regional coal-fired power stations by delivering 1.3 Mt in line with New South Wales Government Coal Directions (Directions). The Directions ceased on 1 July 2024, with the change in royalty rates for open-cut mines increasing 2.6 percentage points, from 8.2 per cent to 10.8 per cent. In FY2024, we renegotiated a contract with Thiess Mining Services for six years to provide contract mining services at the Mt Arthur South Operation.

The application to continue mining for an additional four years from FY2026 to FY2030 was lodged with the New South Wales Government in September 2023 and is currently under assessment, with a determination expected in the first half of CY2025.

We continue to progress plans to cease mining at the asset in FY2030, which includes the completion of progressive rehabilitation commitments during FY2024. We undertook significant engagement with our workforce and community in FY2024 as we worked to consider alternate mine land re-use outcomes for the site.

## Nickel

### Western Australia Nickel



### Overview

Nickel West (BHP ownership: 100 per cent) is a fully integrated nickel business located in Western Australia, with three streams of concentrate. It comprises open-cut and underground mines, concentrators, a smelter and refinery. Nickel West owns the majority of tenements hosting Nickel Sulphide Mineral Resources in the Agnew-Wiluna belt, Western Australia.

Disseminated sulphide ore is mined at the Mt Keith open-pit operation and Mt Keith Satellite mine (Yakabindie) and crushed and processed on-site to produce nickel concentrate. Nickel sulphide ore is mined at the Cliffs and Leinster underground mines and processed through a concentrator and dryer at Leinster. A concentrator plant in Kambalda processes ore and concentrate purchased from third parties.

The three streams feed the Kalgoorlie nickel smelter, which uses a flash furnace to produce nickel matte. The Kwinana nickel refinery then turns this into nickel powder, briquettes and nickel sulphate.



The West Musgrave Project (BHP ownership: 100 per cent; acquired as part of OZ Minerals) is a greenfield nickel and copper project located on Ngaanyatjarra Country in the West Musgrave Ranges of Western Australia, approximately 1,300 kilometres northeast of Perth and 1,400 kilometres northwest of Adelaide, near the intersection of the borders of Western Australia, South Australia and the Northern Territory.

#### Key developments in FY2024

On 11 July 2024, BHP announced Western Australia Nickel would be temporarily suspended from October 2024. We intend to review the decision to temporarily suspend Western Australia Nickel by February 2027.

The decision to temporarily suspend Western Australia Nickel follows oversupply in the global nickel market. Forward consensus nickel prices over the next half of the decade have fallen sharply reflecting strong growth of alternative low-cost nickel supply.

BHP will invest approximately US\$300 million (A\$450 million) per annum following completion of a transition period to support a potential re-start of Western Australia Nickel. The transition period commenced in July 2024. Operations will be suspended in October 2024 and handover activities for temporary suspension will be completed by December 2024. We will continue to support our workforce and local communities during the temporary suspension, including the establishment of a A\$20 million Community Fund.

## 5.2 Copper South Australia

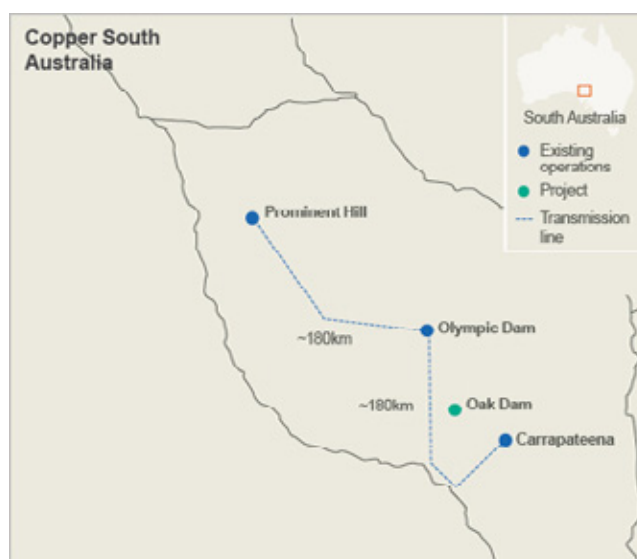

Copper South Australia comprises surface processing and underground mining operations in one of the world's most significant copper, gold, silver and uranium basins. Copper South Australia was formed following our acquisition of OZ Minerals in May 2023 and refers to Olympic Dam, and Carrapateena and Prominent Hill operations, which were acquired from OZ Minerals, and the Oak Dam exploration project. The underground mining and conventional crushing operations of Carrapateena and Prominent Hill produce copper concentrate and are located in close proximity to the mining and integrated crushing, grinding, concentrating, smelting and refining operations of Olympic Dam, which produces copper cathode, gold and silver bullion, and uranium oxide concentrate. The commodities produced by Copper South Australia are transported by road and rail to our domestic customers and via the Adelaide and Whyalla ports to be exported to our global customers.

#### Overview

The Olympic Dam Mine (BHP ownership: 100 per cent) is one of the world's most significant deposits of copper, gold, silver and uranium, located on Kokatha Country in the Gawler Craton, South Australia. It comprises underground mining and surface operations and is a fully integrated processing facility from ore to metal.

Ore mined underground via sub-level open stoping is hauled by an automated train system to crushing, storage and ore hoisting facilities or trucked directly to the surface. Olympic Dam has a fully integrated metallurgical complex with a grinding and concentrating circuit, a hydrometallurgical plant incorporating solvent extraction circuits for copper and uranium, a copper smelter, a copper refinery, including an electro-refinery and an electrowinning-refinery, and a recovery circuit for precious metals.

Carrapateena (BHP ownership: 100 per cent; acquired as part of OZ Minerals) is an underground copper, gold and silver mine located on Kokatha Country in the Gawler Craton, South Australia, approximately 180 kilometres by road southeast of Olympic Dam and 160 kilometres north of Port Augusta. Underground mining at Carrapateena is by sub-level caving. Conventional crushing, grinding and flotation produces copper concentrate.

Prominent Hill (BHP ownership: 100 per cent; acquired as part of OZ Minerals) is an underground copper, gold and silver mine located on Antakirinja Matu-Yankunytjatjara Country in the Gawler Craton, South Australia, 200 kilometres northwest of Olympic Dam. Prominent Hill was first developed as an open-pit mine, however, mining activities have progressed underground via sub-level open stoping since 2012. Conventional crushing, grinding and flotation produce copper concentrate.

The Oak Dam Project (BHP ownership: 100 per cent) is a greenfield copper, gold, silver and uranium deposit located on Kokatha Country in the Gawler Craton, South Australia.

#### Key developments in FY2024

Copper South Australia achieved production of 322 kilotonnes (kt) of payable copper, gold production of 370 thousand troy ounces (ktoz) and 3.6 kt of uranium.

Olympic Dam achieved a record cathode production outcome under BHP operatorship of 216 kt, primarily driven by record mine and smelter performance. Record ore mined was achieved at 10.8 Mt (10.6 Mt FY2014) and record concentrate smelted was achieved at 508.9 kt (507.9 kt FY2023). Strong smelter performance at Olympic Dam was supported by 12.6 kt of concentrate transfers from Prominent Hill and Carrapateena, for processing to higher margin cathode. Record gold bullion production was also delivered in FY2024 at 207 ktoz (186 ktoz FY2023).

The Olympic Dam underground mine continues to develop further into the Southern Mine Area, with approximately 70 per cent of total ore production currently from this part of the mine. Average copper grade remained strong at 2.01 per cent. The short-term focus is on optimising operational performance and debottlenecking existing facilities to further improve production performance.

Resource drilling at Oak Dam continued, with up to 12 deep directional diamond drill rigs on the exploration licence, informing an Inferred Mineral Resource declaration. Drilling at OD Deeps in FY2024 was executed through up to 11 diamond rigs that explored beneath the Iron Oxide Copper Gold (IOCG) orebody at Olympic Dam. Results from this drilling were released as part of the Q2 FY2024 BHP Operational Review.

Carrapateena achieved a record production outcome of 68 kt of payable copper production (60 kt in FY2023). Crusher Station 2 was successfully commissioned in Q3 FY2024 enabling higher productivity from the sub-level cave and record ore mined of 5.2 Mt in FY2024 (4.6 Mt FY2023) enabled milling throughput to increase to record rates of 5.2 Mt (4.7 Mt in FY2023). The bottom half of the Carrapateena orebody is being developed into a block cave, with the aim of unlocking the mine's potential to be a multigenerational, low quartile cash cost producing operation and progress continued in FY2024 with the development of the decline below the current sub-level cave.

In FY2024, Prominent Hill produced 50 kt of payable copper (54 kt in FY2023). Record ore to surface production was achieved at 4.5 Mt (4.4 Mt in FY2023) as development of the underground mine progresses, supported by record underground development of 17.2 kilometres (14.7 kilometres in FY2023). The Prominent Hill Operations Expansion to extend mine life and increase copper production continues works to construct and commission the 6.5 Mtpa ore capacity Wira Shaft. Shaft works advanced and the shaft sink is approximately 35 per cent complete at a current depth of approximately 450 metres.

A funding agreement with the South Australian Government was signed in Q3 FY2024 for a study on the Northern Water Supply Project. Infrastructure South Australia will be undertaking the study for construction of a multi-user coastal desalination plant in the Upper Spencer Gulf to reduce reliance on the Great Artesian Basin.

### 5.3 Minerals Americas

The Minerals Americas asset group includes operated assets, projects and interests in non-operated joint ventures in Canada, Chile, Peru, the United States and Brazil.

Our operated assets in the Americas are Escondida and Pampa Norte, which are open-cut mines that produce copper concentrate and copper cathodes, and the Jansen potash project in Canada. The non-operated assets in the Minerals Americas portfolio are open-cut mines that produce copper (Antamina) and iron ore (Samarco), and the Resolution Copper Project in the United States. The commodities produced by our Minerals Americas assets are transported to port by pipeline, rail or road and exported to customers around the world. In July 2024, we agreed to acquire a 50 per cent interest in the Filo del Sol and Josemaria copper projects in Argentina and Chile with Lundin Mining. If approved, this will give us the opportunity to jointly advance an emerging copper district with world-class potential.

#### Copper

##### Escondida



#### Overview

Escondida (BHP ownership: 57.5 per cent), located in the Atacama Desert in northern Chile, is a leading producer of copper concentrate and cathodes, with by-products including gold and silver.

Escondida's two pits feed three concentrator plants, as well as two leaching operations (oxide and sulphide).

#### Key developments in FY2024

Escondida copper production increased by 7 per cent to 1,125 kt primarily due to higher concentrator feed grade of 0.88 per cent, up from 0.82 per cent in FY2023, as mining progressed into areas of higher-grade ore as planned following the implementation of measures to manage geotechnical events in FY2023. This was partially offset by planned lower cathode production, as a result of prioritising concentrator throughput in prior years. Deployment of autonomous trucks began in the Escondida Norte pit in the second half of FY2024 and will ramp up to approximately 50 autonomous trucks over the next three years.

In FY2024, the largest capacity cable-powered shovel available in the market commenced operations at Escondida, the first in Latin America and third in the world. This and further planned high-capacity shovel deployments will unlock further efficiency in the truck loading process enabling incremental system performance and lower unit cost.

Escondida successfully completed negotiations for a new collective agreement with the Union N°1 of Operators and Maintainers, effective for 36 months from 2 August 2024.

## Pampa Norte

### Overview

Pampa Norte (BHP ownership: 100 per cent) consists of two assets in the Atacama Desert in northern Chile – Spence and Cerro Colorado.

Spence produces copper cathodes and copper concentrate, with by-products including gold, silver and molybdenum.

Cerro Colorado produced copper cathodes up until the asset entered temporary care and maintenance in December 2023.

### Key developments in FY2024

Spence copper production increased by 6 per cent to 255 kt, driven by improved concentrator performance and feed grades. Record concentrate production was partially offset by lower cathode production, in line with an expected decline in stacked feed grade.

In March 2024, Spence achieved fully autonomous mine haulage operations (ahead of the Q4 FY2024 target date) and has deployed a total of 33 autonomous trucks.

The concentrator plant modification, which commenced in August 2022, was completed in June 2024.

In December 2023, Spence achieved gender balance across its total workforce and leadership roles ahead of BHP's aspirational goal to achieve a minimum of 40 per cent female representation by the end of FY2025. During FY2024, Spence successfully completed negotiations for a new collective agreement with Union 2 of Supervisors, effective for 36 months from 1 December 2023 and with Union 1 of Operators and Maintainers effective for 36 months from 1 June 2024.

As disclosed in the Q2 FY2024 Operational Review, changes to the original Spence tailings storage facility (TSF) design were approved and are currently in execution. As we progress execution, we continue to closely monitor the previously identified anomalies to ensure safe operational conditions and studies are ongoing to assess whether further works are required. Production guidance at Spence remains subject to the remediation of the TSF anomalies.

Cerro Colorado transitioned to temporary closure in December 2023, after producing 11 kt in the period. We are assessing the application of novel leaching technologies to utilise latent capacity and allow for a potential restart of operations early next decade.

## Potash

### Jansen potash project

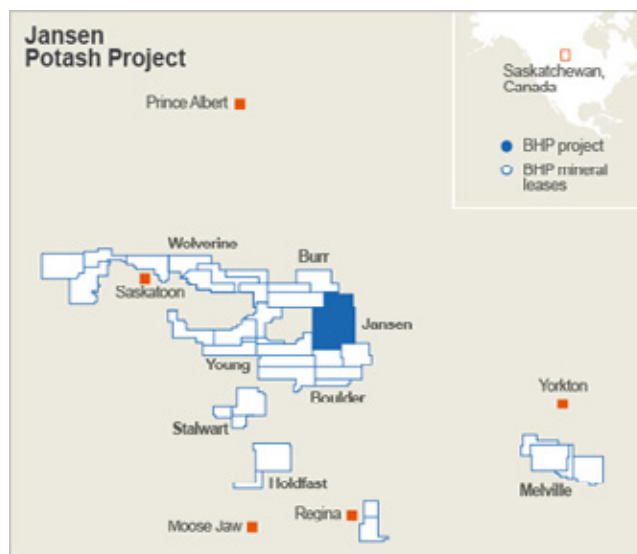

### Overview

The Jansen potash project (BHP ownership: 100 per cent) is located about 140 kilometres east of Saskatoon, Canada.

Jansen's large resource provides the opportunity to develop the project in stages, with Jansen Stage 1 (Jansen S1) expected to produce approximately 4.15 Mt of potash per annum on completion and first production is expected in late CY2026. Approval of the 4.36 Mtpa Jansen Stage 2 (Jansen S2) has increased planned production to approximately 8.5 Mtpa, with further brownfield expansions up to 8 Mtpa (approximately 4 Mtpa per stage).

BHP holds mineral leases covering around 9,600 square kilometres in the Saskatchewan potash basin.

### Key developments in FY2024

Jansen S1 is ahead of the original schedule and was 52 per cent complete as at 30 June 2024. During FY2024, we successfully commissioned Jansen's permanent power substation, while also advancing steelwork and equipment installation for surface and underground. Port construction transitioned from ground improvement to civil and concrete works.

In October 2023, BHP approved an investment of US\$4.9 billion for Jansen S2, following completion of the feasibility study, in line with plan. Execution of Jansen S2 commenced and is expected to take approximately six years, with first production targeted for FY2029, followed by a three-year ramp-up period.

## Copper

### Non-operated minerals joint ventures

#### Antamina



#### Overview

Antamina (BHP ownership: 33.75 per cent), located in north central Peru, is a large, low-cost copper and zinc mine with by-products including molybdenum and silver. Antamina is operated independently by Compañía Minera Antamina S.A.

#### Key developments in FY2024

Antamina copper production increased by 4 per cent to 144 kt (BHP share) as a result of record concentrator throughput offsetting lower planned feed grades. Zinc production was 17 per cent lower at 103 kt (BHP share) reflecting planned lower feed grades.

In FY2024, Peruvian authorities approved Antamina's Modification of the Environmental Impact Assessment (MEIA), extending the life of Antamina from CY2028 to CY2036.

#### Resolution Copper

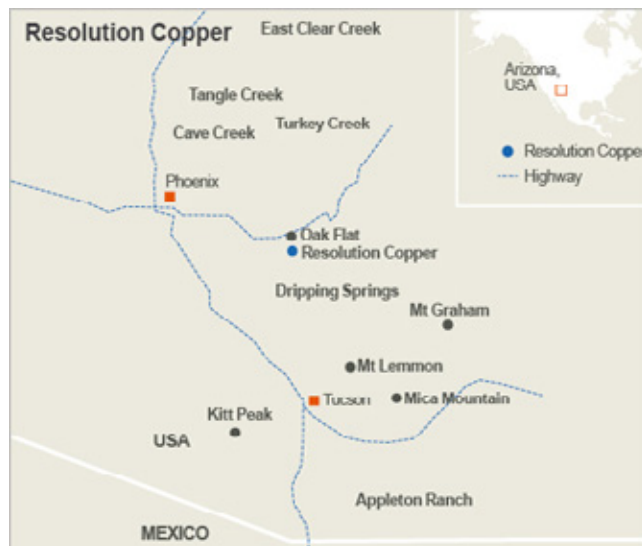

#### Overview

Resolution Copper (BHP ownership: 45 per cent), located in the US State of Arizona, is one of the largest undeveloped copper projects in the world and has the potential to become one of the largest copper producers in North America. Resolution Copper is operated by Rio Tinto (55 per cent ownership).

#### Key developments in FY2024

During FY2024, Resolution Copper continued the engineering and permitting phase of the project. The project is subject to a Final Environmental Impact Statement (FEIS), which is a federal permitting process led by the US Forest Service. The US Forest Service published a FEIS in January 2021, which was rescinded in March 2021 to allow additional environmental analysis and consultation with Native American Tribes. The US Forest Service has indicated there is no timeline for republication of the FEIS, which is subject to three lawsuits filed against the US Forest Service on behalf of Native American Tribe members and non-government organisations. Resolution Copper has publicly stated its commitment to deepening ongoing engagement with Native American Tribes and other stakeholders while collaborating to create shared value opportunities. As part of the permitting process, the US Government has continued to consult with Native American Tribes resulting in the identification of mitigation strategies for cultural heritage areas in the project area.

## Iron ore

### Non-operated minerals joint venture

#### Samarco

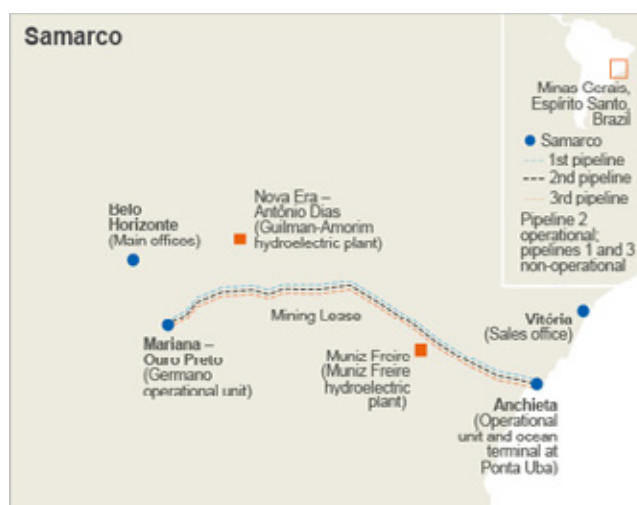

#### Overview

Samarco (BHP ownership: 50 per cent) comprises a mine and three concentrators located in the Brazilian state of Minas Gerais, and four pellet plants and a port located in Anchieta in the state of Espírito Santo. Three 400-kilometre pipelines connect the mine site to the pelletising facilities. Samarco is operated independently by Samarco Mineração S.A. Samarco's main product is iron ore pellets, which are independently marketed by Samarco and sold to customers around the world.

Samarco's operations were suspended in November 2015 after the Fundão dam failure. Since resuming operations in December 2020, 80 per cent of the tailings generated are filtrated and dry stacked, and 20 per cent are deposited in a confined pit enabling Samarco to operate without a conventional tailings dam structure.

#### Key developments in FY2024

Samarco increased iron ore pellets and ore fines production in FY2024 by 5 per cent to 4.7 Mt (BHP share). Samarco is currently operating at 31 per cent of its total 26 Mtpa (100 per cent basis) production capacity and has shipped more than 29 Mt (100 per cent basis) of pellets and fines since the resumption of operations in December 2020. In June 2023, Samarco Board of Directors approved investment to increase production to approximately 60 per cent of its full capacity through restarting the second concentrator and third pelletising plant, expanding the existing filtration plant and increasing the mine fleet. Project execution is on track with first production expected in early CY2025.

In December 2023, Samarco completed a restructure of its debts under the Judicial Reorganisation process, which included payments to employees and suppliers and the issue of new unsecured debt to Samarco's financial creditors. The restructure provides Samarco with a stable financial position to continue to rebuild its operations and strengthen its ability to meet its remediation and compensation obligations related to the Fundão dam failure. This also benefits neighbouring communities through job creation, investment and taxes.

Samarco has been progressively decommissioning its upstream tailings dam structures in accordance with Brazilian legislation. Decommissioning works for the smaller of the two tailings dams, the Germano Pit dam, were completed during FY2023 and formally approved by state authorities in FY2024.

The progressive decommissioning of the remaining upstream tailings dam structure, the Germano Main dam, is on track for completion by FY2029.

These structures have been certified as stable by independent third parties and are compliant with local stability and monitoring requirements. In addition, Samarco is now fully compliant with the Global Industry Standards on Tailings Management (GISTM) requirements.

Samarco is continuing broader studies to review solutions to operate without tailings dams beyond FY2030.

#### For more information on the Fundão dam failure and the response refer to OFR 7

#### 5.4 Commercial

BHP's Commercial function seeks to maximise commercial and social value while minimising costs across the end-to-end supply chain. The function is organised around core activities in our value chain, supported by risk governance and analytics.

#### Sales and Marketing

The Sales and Marketing team connects BHP to the market through commercial expertise, sales and operations planning, customer insights and proactive risk management. It presents a single face to market across multiple assets, with a view to realising maximum value and supporting sustainability initiatives in our value chain.

#### Maritime and Supply Chain Excellence

The Maritime and Supply Chain Excellence team manages BHP's enterprise-wide maritime transportation strategy and the chartering of ocean freight to meet BHP's inbound and outbound transportation needs. It focuses on supply chain excellence and sourcing cost-efficient marine freight in addition to engaging within the maritime ecosystem with a view to uplifting overall safety standards in the industry, promoting seafarer welfare and supporting GHG emissions intensity reduction initiatives. It also seeks to manage supply chain risk by vetting the safety performance of the ships loading BHP cargo and partnering with reliable vessel owners with excellent operational and safety standards.

#### Procurement

Our global Procurement team connects asset teams and suppliers to procure the goods and services used by our projects, operated assets and functions globally. Procurement partners with our suppliers to optimise safety, equipment performance, reduce operating costs, optimise working capital and generate social value. Through innovation, we work with our suppliers to support opportunities to reduce the GHG emissions intensity of inbound goods and services and the operational GHG emissions of our operated assets. Procurement manages supply chain risk, fosters supplier innovation and looks to develop positive and enduring relationships with global suppliers and local businesses in the communities where we operate.

### **Market Analysis and Economics**

Our Market Analysis and Economics team develops BHP's proprietary view on the outlook for commodity demand and prices, as well as our input costs, the world economy and financial markets, and the potential impact of climate change in those contexts. The team works with our Procurement, Maritime and Sales and Marketing sub-functions to help optimise end-to-end commercial value and with the Portfolio Strategy and Development and External Affairs functions to identify and respond to long-run strategic changes in our operating environment.

### **Global Business Services**

The Global Business Services team integrates repeatable process activity across the Group into a single shared services operation. With the BHP Operating System and process transformation capabilities at its core, the team has the mandate to aggregate, operate and improve end-to-end processes on behalf of assets and functions to drive operational excellence.

For personal use only

## 6 Sustainability

Sustainability is key to our purpose of bringing people and resources together to build a better world and is core to our strategy.

>[For more information on BHP's approach to and definition of sustainability refer to OFR 6 and Additional information 10.4](#)

### 6.1 Safety

Protecting the safety and wellbeing of our workforce and the communities where we operate is of the highest importance at BHP and is underpinned by Our Values.

In January 2024, a valued contracting colleague, Luke O'Brien, was fatally injured at our BMA Coal operations in Queensland in a vehicle-related event. The investigation findings were shared internally with relevant stakeholders to broaden and inform operational learning and improvement. Our investigation into the previous year's fatal event, involving Nathan Scholz at Olympic Dam, is being finalised while external review processes are ongoing.

These tragic events reinforce the need to continue to deepen our understanding of the causes of fatal incidents so we can strengthen our controls. We continue to focus proactively on integrating safety in the way work is performed through our BHP Operating System (BOS) and strive to improve the quality of our global Field Leadership Program and uplift safety leadership capability across our organisation.

We believe a positive workplace culture built on care and trust will enable us to understand more about the work conditions that increase risk to our workforce and influence how work is executed. We also believe learning from those who perform the work and are closest to the risks gives us greater insight into how we can improve fatal risk control verification. This approach recognises that work is complex due to the interactions that occur between people, equipment/tools, processes, systems and culture, and how they influence one another can impact safety outcomes.

Leaders play an instrumental role in shaping our organisation's culture. Our General Managers Integrated Leadership Forum is an example of how we are growing organisational capability and embedding BOS principles. The forum promotes strong safety leadership discussions, reinforcing 'felt leadership', collaboration and connection as we seek better ways to learn and improve together.

#### Our safety performance

In FY2024 we recorded:<sup>1</sup>

- one fatal incident involving a vehicle, where a valued colleague undertaking contract work lost their life
- a 36 per cent decrease in the high-potential injury frequency rate from FY2023. The highest number of events with the potential for one or more fatalities was related to vehicle and mobile equipment incidents. We closely monitor high-potential injury trends and focus on identifying the contributing factors to help inform fatality risk control improvements
- a 5 per cent increase in total recordable injury frequency (TRIF) from FY2023. The highest number of recordable injuries related to slips, trips and falls for employees and contractors. The second-highest number of injuries for employees related to being hit by a moving object and for contractors related to being caught between objects
- an increase in field leadership activities compared to FY2023 performance, at a frequency rate of 9,868 activities per million hours worked with over 1.8 million activities completed. We understand the importance and value of sustaining the quality of these engagements and we continue to promote coaching, a key element of our scheduled work routines, as an important tool for achieving this. The field leadership coaching rate was 42 per cent for Layered Audits and Critical Control Observations, remaining on par with the previous year

This section includes FY2024 safety data and information relating to the former OZ Minerals operations that form part of our Copper South Australia asset and the West Musgrave Project (acquired as part of BHP's acquisition of OZ Minerals on 2 May 2023) unless expressly stated otherwise.

#### Performance data – workforce health and safety for FY2024<sup>1</sup>

##### High-potential injuries

Year ended 30 June	2024	2023	2022	2021
High-potential injuries	21	30	24	33
	Employees		Contractors	
High-potential injury frequency <sup>2</sup>	0.03		0.02	

##### Total recordable injury frequency (per million hours worked)

Year ended 30 June	2024	2023	2022	2021
Total recordable injury frequency <sup>3</sup>	4.7	4.5	4.1	3.8
	Employees		Contractors	
Total recordable injury frequency <sup>2</sup>	1.05		0.89	

1. Prior year data (FY2021 to FY2023) excludes former OZ Minerals assets (acquired 2 May 2023) and divested operations as follows: BHP Mitsui Coal (sale completed on 3 May 2022) and BHP's oil and gas portfolio (merger with Woodside completed on 1 June 2022). Divested BMA assets, Daunia and Blackwater (divested on 2 April 2024) are included in FY2024 data up until the date of divestment.

2. Employee and contractor frequency per 200,000 hours worked.

3. Combined employee and contractor frequency per 1 million hours worked.

As we learn year on year, we continue to look for opportunities to improve the application of the following programs and systems as outlined in the sections below:

- Fatality Elimination Program – asset-based fatality risk control implementation plans aimed at eliminating fatalities at our operations by having effective controls in place
- Field Leadership – enabling a culture of care, standard setting and supporting risk control verification
- Contractor Management – helping to protect the health and safety of our contractors is an important element of asset-based health and safety management systems

### **Fatality Elimination Program**

It is paramount that we continue to learn, improve and focus on opportunities to verify and strengthen our critical risk control framework to more effectively manage and prevent fatality risks.

We developed and introduced the Fatality Elimination Program (FEL) program in 2020. The FEL program requires our assets to implement fatal risk controls across their respective material safety risk profiles. The FEL program remains a high priority across BHP, with an intended completion of asset FEL control implementation plans in FY2025. Asset implementation plan progress against the FEL program is measured and tracked by the Executive Leadership Team and BHP scorecard to ensure visibility at the highest level. Post FY2025, ongoing asset control implementation and improvements will be managed via the existing risk evaluation process.

We will continue to evolve our approach to safety risk management and our understanding of what conditions and factors influence the cause of incidents and the verification and validation of fatal risk controls.

In FY2024:

- On average, assets achieved over 90 per cent compliance for FEL program controls implemented according to the plan for this financial year.
- We continued implementation of the five-year fatality elimination roadmap, including the recommended sequencing of strengthened controls based on effort, cost and near-miss reduction impact.
- We continued to undertake data analysis and insights into our high-potential near-miss and actual events, moving from three-monthly to six-monthly reviews, to identify more meaningful themes over a longer sampling period. This included a continued focus on the relevant risks, controls and conditions that may increase the likelihood of incidents.
- We identified ongoing FEL program fatal risk control verification and improvement opportunities via regional-focused assurance activities.
- We continued to review the Fatal Risk Control Management Framework to improve how we manage single-fatality occupational safety risk, with vehicle and mobile equipment remaining our highest risk. This ongoing work involves deepening our organisational understanding of risk and what causes incidents, improved performance standards and the quality of our fatal risk control verification and assurance programs.

### **Field Leadership Program**

Leaders spending time in the field fosters a culture of care, which helps to maintain safe operations. Our global Field Leadership Program encourages the workforce to provide feedback to their leaders about safety issues and concerns, and may also include sharing insights into safer ways of working. It involves leaders having quality two-way conversations with workers in the field and drives a common approach to improving health, safety and environment (HSE) performance. The program helps verify that critical safety controls are in place, being applied and are effective in managing risks that have the potential to result in fatalities.

The global field leadership tools include Layered Audits, Critical Control Observations, Planned Task Confirmations and Take Time Talks, and are supported by coaching routines.

In FY2024 we continued to:

- improve the quality of field leadership activities by increasing training and coaching, and delivering field leadership engagements across all levels of the organisation
- conduct field leadership activities to support the verification of risks that have the potential to result in injuries or illnesses and fatalities across our operated assets
- embed the global field leadership procedure, which is designed to increase the effectiveness of field leadership activities across the business



## Contractor management

Our commitment to safety includes helping to protect the many thousands of contractors who represent a significant part of our total workforce.

Our approach to contractor management is intended to make it safer and easier for contractors to work with us and designed to support an inclusive, respectful and caring workplace culture. We have an asset-focused approach to contractor management, with our contract owners playing a significant role in helping us improve our partnerships with BHP service providers. Contract owners work collaboratively with contractors to deliver work safely under the conditions of their contract and in accordance with our mandatory minimum requirements for contractor management and the respective asset safety management plans and systems.

In FY2024 we:

- simplified our mandatory minimum requirements for contractor management under an asset-focused model
- undertook internal assurance and audit activities at an asset level
- Transitioned the Integrated Contractor Management (ICM) project, which included facilitating contractor mobilisation to an asset-led model

**>For more information on safety refer to [bhp.com/safety](https://bhp.com/safety)**

## 6.2 Our sustainability approach

The way we produce our commodities and how we responsibly manage our sustainability-related impacts is critical to our future. Our stakeholders and partners are increasingly focused on our sustainability performance and use it as a key metric in assessing BHP and our industry.

We define our approach to sustainability through our purpose and Our Values, which are governed through our *Global Standards*. These standards describe our mandatory minimum performance requirements and provide the foundation for sustainability performance at our operated assets and in our functions.

Our social value framework expands on and deepens our long-standing commitment to sustainability.

**>For information on our approach to social value, including the aspirational goals and associated metrics we have set for ourselves, refer to OFR 6.5**

**>For information on our governance of sustainability, including the FY2024 improvement project for our internal Group-wide standards, refer to OFR 6.3**

There are a number of voluntary global sustainability frameworks, standards, benchmarks and initiatives that we seek to comply with. We continue to report against the Global Reporting Initiative (GRI) Standards, the Sustainability Accounting Standards Board (SASB) Mining and Metals Standards and the recommendations of the Taskforce on Climate-related Financial Disclosures (TCFD) in addition to engaging on consultations relating to the International Sustainability Standards Board (ISSB) standards. During FY2024, the trend towards mandatory sustainability-related frameworks increased, and we continue to monitor these developments for their potential application to BHP, including the proposed Australian Sustainability Reporting Standards (ASRS), the EU Corporate Sustainability Reporting Directive (CSRD) and the EU Corporate Sustainability Due Diligence Directive (CSDDD).

**>For information on our engagement with climate-specific regulatory developments refer to OFR 6.9**

In FY2024, we continued our commitment to a number of responsible production and sourcing standards, which require self-assessment and third-party verification of management systems and performance at an asset, operation or facility level. These standards, such as the International Council on Mining and Metals (ICMM) Performance Expectations, Towards Sustainable Mining and the Copper Mark, require disclosure of our performance against detailed requirements across a broad range of sustainability topics.

Details of the voluntary sustainability standards that we have reported against for FY2024 are set out in the BHP ESG Standards and Databook 2024.

**>The BHP ESG Standards and Databook 2024 is available at [bhp.com/ESGStandards2024](https://www.bhp.com/ESGStandards2024)**

Our Modern Slavery Statement 2024 is prepared under the Australian Modern Slavery Act 2018 and UK Modern Slavery Act 2015 and outlines our management of modern slavery risks. In May 2024, BHP Canada Inc. published its first modern slavery statement under Canada's newly enacted Fighting Against Forced Labour and Child Labour in Supply Chains Act for the financial year 1 July 2022 to 30 June 2023.

**>The BHP Group Modern Slavery Statement 2024 is available at [bhp.com/MSS2024](https://www.bhp.com/MSS2024)**

### Treatment of former OZ Minerals and divestment of Daunia and Blackwater coal mines

This Report includes FY2024 sustainability-related data and information relating to the former OZ Minerals operations that form part of our Copper South Australia asset and the West Musgrave Project (acquired as part of BHP's acquisition of OZ Minerals on 2 May 2023), unless expressly stated otherwise in the relevant section. Prior year sustainability-related data and information has not been adjusted and restated unless expressly stated otherwise. Former OZ Minerals Brazil sustainability-related data and information has been excluded from this Report unless otherwise expressly stated. Where OZ Minerals Brazil data is included as required to meet legal and regulatory requirements or as necessary to meet applicable voluntary standards and benchmarks, that data has been prepared in accordance with former OZ Minerals standards due to ongoing strategic review of these assets by BHP.

This Report includes sustainability-related data and information relating to BMA's Daunia and Blackwater coal mines up to completion of their divestment on 2 April 2024, unless expressly stated otherwise in the relevant section.

## 6.3 Sustainability governance

The BHP Board has oversight of our sustainability approach and performance and is supported by each of its Committees.

**>For information on BHP's governance structure, including the work of the Board and each Committee refer to the Corporate Governance Statement**

**>For information on the governance of climate change refer to OFR 6.9 and the BHP Climate Transition Action Plan 2024 available at [bhp.com/CTAP2024](https://www.bhp.com/CTAP2024)**

During FY2024, we launched our new *Global Controlled Documents* suite following an improvement project to streamline the mandatory minimum performance requirements set in our internal Group-wide standards. This included updates across the suite of sustainability-related *Global Standards* (previously *Our Requirements* standards) relating to Climate Change, Environment, Community and Indigenous Peoples and the introduction of a new *Social Value and Sustainability Global Standard*. These improvements seek to make our requirements and our ways of working easier for our people to understand and apply.

**>External versions of key sustainability-related elements of these *Global Standards* are available at [bhp.com/about/operating-ethically/corporate-governance](https://bhp.com/about/operating-ethically/corporate-governance)**

Our management-level Sustainability and ESG Steering Committee (ESG SteerCo) undertakes review of a range of cross-functional and strategic issues relating to key sustainability and ESG topics. Issues under the remit of the ESG SteerCo are driven by regular assessment of materiality and relative priority and determined in line with BHP’s social value framework pillars. In FY2024, the membership of the ESG SteerCo included the Chief Legal, Governance and External Affairs Officer, the Chief Operations Officer, the Chief Commercial Officer, the Chief Financial Officer and the Presidents of Minerals Americas and Minerals Australia from the Executive Leadership Team (ELT) as well as sustainability and ESG leaders within BHP. Matters considered by the ESG SteerCo may also be subject to review or approval by the ELT and the Board or its Committees, in accordance with their remits.

The ESG SteerCo met four times during FY2024. They discussed topics including our community and human rights impact and opportunity assessments, nature-positive plans to support progress against our 2030 Healthy environment goal, environmental performance, sustainability standards strategy and implementation, and preparation of our Climate Transition Action Plan 2024.

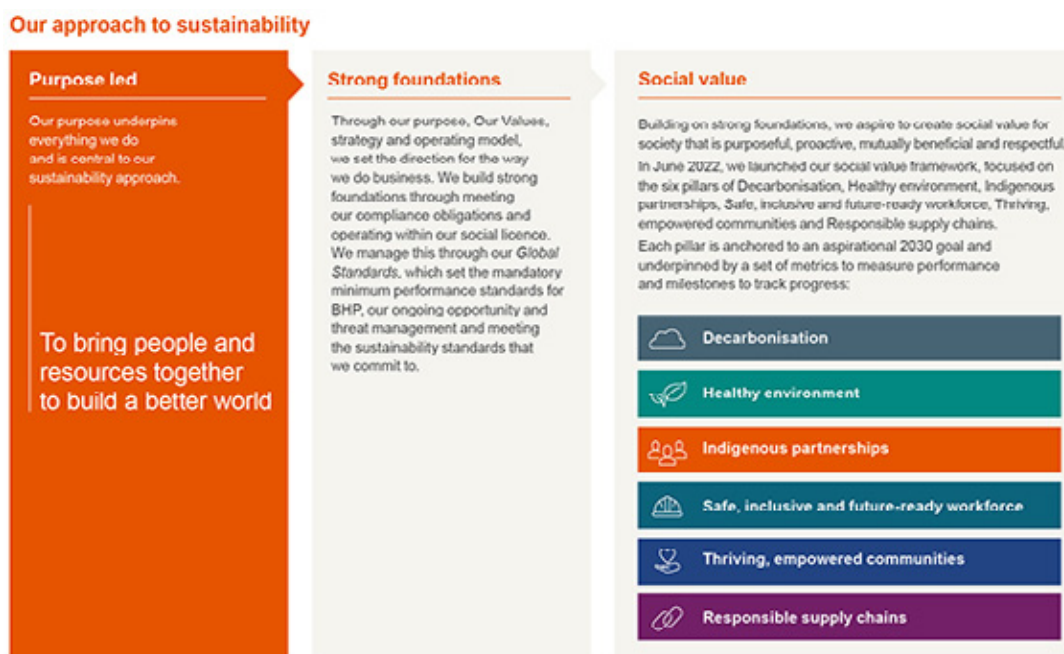

## 6.4 Material topics for sustainability reporting

### Annual sustainability materiality assessment

Each year we determine which sustainability topics are considered most material to our business, partners and stakeholders for the purpose of our sustainability-related reporting (which may differ from the materiality standards applied by other reporting regimes) by undertaking an impact materiality assessment in alignment with the recommendations of the GRI. These topics are referred to as our material sustainability topics. The findings of this assessment help us determine the information our stakeholders are seeking and therefore the material sustainability topics for disclosure in OFR 6. In FY2024 we have consolidated the material topics within OFR 6 compared to FY2023 and we have reported on value chain sustainability and tailings storage facilities within OFR 6.4, sexual harassment within OFR 6.6, and digital security and data privacy within OFR 8.1.

Our materiality assessment considers our potential and actual positive and negative impacts by an assessment of a broad range of inputs, including BHP’s material risk profile (refer to OFR 8), information recorded in our internal event management system, our social value framework, topics raised at our Annual General Meeting (AGM) and industry standards and guidance. Our assessment aims to capture our external partners’ and stakeholders’ perspectives through incorporating consideration of issues raised at our AGM and investor roundtables, industry sustainability standards and guidance, sustainability-related regulatory focus areas, and relevant media articles about our impacts. Sustainability-related impacts can arise from our direct operational activities, such as managing tailings storage facilities, or result from activities within our value chain, such as procuring goods and services from our suppliers. We aim to address this in our materiality assessment by considering a broad range of inputs and perspectives. Our material sustainability topics are reviewed by the Sustainability Committee annually.

**>For more information on our materiality assessment for sustainability reporting refer to [bhp.com/sustainability](https://bhp.com/sustainability)**

The material sustainability topics identified in this assessment are shown against our social value pillars, as illustrated in the table on page 39 together with the sections of OFR 6 that address these topics and the most relevant risk factors as described in OFR 8.1, and are largely consistent with FY2023.

**>For more information on the process by which we identify and manage risk at BHP and our risk factors, which include sustainability-related risks, refer to OFR 8**

## Material topics and impacts for sustainability reporting

Material topic and overview of potential and actual impacts	Most relevant risk factors	SDG index	Read more
<b>Decarbonisation</b>			
<b>Climate change</b> We recognise climate change may pose risks to fundamental human rights, including the rights to life, health, food and an adequate standard of living. We continue to work towards our climate change targets and goals and the implementation of our climate change adaptation strategy.	8.1 Operational events 8.1 Significant social or environmental impacts 8.1 Low-carbon transition 8.1 Inadequate business resilience	 	 6.9 Climate change
<b>Healthy environment</b>			
<b>Biodiversity and land management</b> The nature of our operations can have significant environmental impacts and those impacts can adversely affect human rights.	8.1 Operational events 8.1 Significant social or environmental impacts 8.1 Inadequate business resilience	 	 6.10 Environment and nature – biodiversity
<b>Water</b> Access to safe, clean water is a basic human right and water is essential to maintaining healthy ecosystems, cultural and spiritual values and sustaining economic growth. Unmanaged or uncontrolled operational water-related risks have the potential to adversely impact the health and safety of our employees, contractors and community members, spiritual and cultural values, communities, environmental resources, BHP's legal rights to continue operations and compliance with regulations.	8.1 Operational events 8.1 Significant social or environmental impacts 8.1 Inadequate business resilience		 6.10 Environment and nature – oceans and fresh water
<b>Indigenous partnerships</b>			
<b>Indigenous peoples</b> Many of our operations globally are located on or near Indigenous traditional lands and we acknowledge that potential impacts of our operations may extend beyond direct physical impacts and include impacts on intangible cultural heritage or on Indigenous peoples' culture and way of life.	8.1 Operational events 8.1 Significant social or environmental impacts 8.1 Ethical misconduct		 6.12 Indigenous peoples
<b>Safe, inclusive and future-ready workforce</b>			
<b>Safety</b> The nature of our business is such that our workforce can be exposed to risks that can impact their safety and long-term wellbeing.	8.1 Operational events 8.1 Inadequate business resilience		 6.1 Safety
<b>People</b> Our ambition is to have a workforce that is truly representative of the societies where we operate, across attributes of indigeneity, gender, age, race, disability, sexuality, carer and veteran status and the intersectionality between them. We acknowledge the presence of sexual harassment and sexual assault in the mining industry and BHP considers it a material health and safety risk.	8.1 Significant social or environmental impacts 8.1 Ethical misconduct	 	 6.6 People
<b>Health</b> We recognise our working environments can impact and potentially expose our workforce at our offices and operated assets to potential health and wellbeing impacts.	8.1 Operational events 8.1 Inadequate business resilience	 	 6.7 Health
<b>Thriving, empowered communities</b>			
<b>Community</b> Human rights of community members may potentially be impacted, including rights related to freedom of expression and self-determination as well as economic, social and cultural rights, such as health and wellbeing, work, adequate housing and water and sanitation.	8.1 Operational events 8.1 Significant social or environmental impacts 8.1 Ethical misconduct		 6.11 Community
<b>Other</b>			
<b>Ethics and business conduct</b> Corruption can adversely impact the human rights of community members.	8.1 Ethical misconduct 8.1 Accessing key markets		 6.8 Ethics and business conduct

### Respecting human rights

We recognise we have the potential to cause, contribute to or be directly linked to human rights impacts through our operations and supply chain primarily relating to workplace health and safety, labour rights, activities of security providers, land access and use, water and sanitation, community wellbeing, and Indigenous peoples' rights relating to culture, identity, traditions and customs.

Our Human Rights Policy Statement and relevant standards outline our commitment and approach to respecting human rights and the principles by which we conduct our human rights due diligence. This involves taking a rights-based approach for our own operations and for modern slavery-related risks in our supply chain to identify and assess actual and potential impacts, considering how impacts may affect people, integrating and acting upon the findings, monitoring effectiveness, and communicating how actual and potential impacts are addressed.

In FY2023, BHP developed and commenced implementation of a globally consistent methodology for our community and human rights impact and opportunity assessments (CHRIOAs), which identified potential impacts and risks to local communities where we operate. The methodology design incorporated consideration of relevant human rights in accordance with our Human Rights Policy Statement, views from our stakeholders and the United Nation Guiding Principles on Business and Human Rights (UNGPs) approach to identifying and prioritising salient human rights issues. During FY2024, an external human rights expert reviewed the approach and provided feedback on the CHRIOA process to further strengthen our approach to identifying potential human rights impacts, which we will seek to incorporate in FY2025. The methodology is described in more detail in OFR 6.11.

## Responsible sourcing and production standards performance

We recognise there are sustainability-related opportunities and impacts across our value chain. BHP has voluntarily committed to the adoption of a set of external standards for the responsible production and sourcing of minerals and metals, as outlined in OFR 6.2. Our performance is assured against these standards by an independent third party and this allows us to more transparently demonstrate to our stakeholders our intent to be a responsible actor within the mining and metals industry and within global value chains for our products. This also helps us align with sustainability-related requirements set out by national mining associations, industry associations, commodity exchanges and relevant emerging regulations.

Relevant Australian operated assets continued to progress implementation of the Towards Sustainable Mining framework, as part of the three-year implementation phase and in preparation for public reporting by the end of CY2025.

Our Escondida and Spence operations in Chile and Olympic Dam operations in Australia were previously assured against The Copper Mark Criteria Guide (reference 24 January 2020) and continue work to prepare for their next assessments. The Copper Mark is a voluntary assurance framework that independently assesses participants against 32 performance criteria across environmental, social and governance dimensions.

During FY2024, Escondida, Spence, Olympic Dam and Nickel West (which produced brands listed on the London Metal Exchange (LME)) successfully completed third-party verification for the FY2023 period against the Joint Due Diligence Standard (JDDS) as an OECD-aligned and LME-approved standard. For Escondida, Spence and Olympic Dam, JDDS certificates were issued under the broader Copper Mark certification while Nickel West was issued a standalone JDDS certificate by The Copper Mark.

Our Responsible Minerals Program (RMP) is our minerals and metals supply chain due diligence program that applies to minerals and metals that we source from third parties (either for feedstock or third-party trading purposes). The RMP has been designed to align with the OECD's Due Diligence Guidance for Responsible Supply Chains of Minerals from Conflict-Affected and High-Risk Areas. We are currently undertaking a project to develop and integrate an expanded scope of environmental risks that will seek to align the due diligence undertaken within the RMP with the OECD's Handbook on Environmental Due Diligence in Mineral Supply Chains.

Under the Responsible supply chains pillar of our social value framework, we seek to create sustainable, ethical and transparent supply chains together with our partners. One of the FY2024 short-term milestones within the Responsible Supply Chains pillar outlined in OFR 6.5 that we met was to determine ethical supplier improvement plans with partners, where required. The Ethical Supply Chain and Transparency (ESCT) team within Compliance reviews audit reports prepared by our third-party audit provider and monitors corrective action taken by suppliers in response to audit findings.

**>For more information on our supplier due diligence approach refer to the Summary of FY2024 audits in the BHP Group Modern Slavery Statement 2024 available at [bhp.com/ MSS2024](https://bhp.com/MSS2024)**

**>For more information on our Responsible Minerals Program refer to our Responsible Minerals Program Report 2024 available at [bhp.com/-/media/documents/environment/2024/240827\\_BHPResponsibleMineralsProgramReport2024](https://bhp.com/-/media/documents/environment/2024/240827_BHPResponsibleMineralsProgramReport2024)**

**>For more information on our approach to value chain sustainability refer to [bhp.com/sustainability/valuechainsustainability](https://bhp.com/sustainability/valuechainsustainability)**

### Global Industry Standard on Tailings Management

As an ICMM member, BHP has committed to achieving alignment with the Global Industry Standard on Tailings Management (GISTM) for all BHP-operated tailings storage facilities (TSFs). BHP is focused on safety and the integrity of TSFs at our operated assets to protect people and the environment. In August 2023, we disclosed an overview of our conformance against the GISTM for our TSFs with a GISTM classification of Very High or Extreme rated facilities as at 31 July 2023 (excluding the four TSFs introduced to the BHP portfolio by the acquisition of OZ Minerals in May 2023), based on a self-assessment. Our August 2024 public disclosure is an update of the 2023 disclosure, and also includes the results of third-party validation of 10 of these TSFs and the remainder will be included in future disclosures.

In accordance with the timeline for members of the ICMM, work towards GISTM conformance has been progressed for the 49 remaining BHP-operated TSFs and we plan to disclose an overview of our conformance in August 2025. Further detail is reported in the GISTM public disclosure document.

**>For our Global Industry Standard on Tailings Management Public Disclosure 2024 refer to [bhp.com/sustainability](https://bhp.com/sustainability)**

**>For more information on tailings storage facilities refer to [bhp.com/sustainability/tailings-storage-facilities](https://bhp.com/sustainability/tailings-storage-facilities)**

## 6.5 2030 goals

### Our social value scorecard

Our social value framework, 2030 goals and social value scorecard were first published in June 2022. Since then, we have worked to embed social value into our decision-making through processes and systems, such as:

- carrying out social value assessments for our operated assets to identify social value priorities ahead of the annual planning cycle
- utilising our non-economically quantifiable impact (NEQI) framework to systematically identify, consistently evaluate and transparently present actual and potential social value impacts for consideration in our investment decisions where applicable

We provide progress on our 2030 goals through our social value scorecard. The scorecard is intended to evolve over time as our plans mature and to keep pace, as appropriate, with our internal and external environment. Our performance in FY2024 against the scorecard and our new FY2025 milestones are provided on page 41 to demonstrate our progress towards our 2030 goals.

**> For more information on how the metrics and milestones support progress towards our 2030 goals and the methods we use to measure progress refer to the BHP ESG Standards and Databook 2024 available at [bhp.com/ ESGStandards2024](https://bhp.com/ ESGStandards2024)**

**Social investment**

Guided by our social value framework, our social investment aims to make a meaningful contribution to addressing the sustainable development challenges of most relevance to our business, partners and stakeholders.

In FY2024, our voluntary social investment totalled US\$136.7 million. This investment consisted of US\$102.4 million in direct funding for initiatives in line with our social value framework, US\$15.2 million to non-operated joint venture social investment programs, and US\$1.8 million under the BHP Matched Giving Program. Administrative costs to facilitate social investment activities totalled US\$12.5 million and US\$6.4 million supported the operations of the BHP Foundation.

>For more information on our social investment, including case studies and performance against our global social investment indicators, refer to [bhp.com/sustainability/approach/social-investment](https://bhp.com/sustainability/approach/social-investment)

>For more information on the BHP Foundation refer to [bhp-foundation.org](https://bhp-foundation.org)



**Footnotes**

1. With widespread adoption expected post-2030. We have revised the language used in our medium-term goal for steelmaking to provide greater clarity and reflect the range of steelmaking process routes that now form part of our strategy. This is due to technology advances as well as the evolution of our strategy. For more information refer to the BHP Climate Transition Action Plan 2024 available at [bhp.com/CTAP2024](https://bhp.com/CTAP2024).

2. For the definition of the terms used to express these positions, including ‘target’, ‘goal’, ‘net zero’, ‘carbon neutral’ and ‘operational GHG emissions’ refer to Additional information 10.4. For more information on the essential definitions, assumptions and adjustments for our targets and goals refer to Metrics, targets and goals in OFR 6.9.
3. Nature-positive is defined by the TNFD Glossary version 1.0 as ‘A high-level goal and concept describing a future state of nature (e.g. biodiversity, ecosystem services and natural capital) which is greater than the current state’. We understand it to include land and water management practices that halt and reverse nature loss – that is, supporting healthy, functioning ecosystems. BHP intends to review this definition in FY2025, in light of the recently revised TNFD Glossary version 2.0 (June 2024) definition of nature-positive.
4. Excluding areas we hold under greenfield exploration licences (or equivalent tenements), which are outside the area of influence of our existing mine operations. 30 per cent will be calculated based on the areas of land and water that we steward at the end of FY2030. For more information refer to the BHP ESG Standards and Databook 2024 available at [bhp.com/sustainability](https://bhp.com/sustainability). For an overview of the operational area (i.e. disturbed area) and non-operational area within our own operational footprint that is the boundary of our 2030 Healthy environment goal, and their size and relativity to one another refer to the infographic in OFR 6.10.
5. For our FY2024 key metric, while some of the land related to the Daunia and Blackwater mines is pending transfer following BMA’s divestment of these mines on 2 April 2024, these areas are no longer under BMA’s control or operated for BMA’s benefit so have been excluded from the areas of land and water we stewarded at 30 June 2024.
6. Cultural diversity in our workforce will be measured based on our substantive progress towards reflecting the cultural diversity of the societies where we operate.
7. Baseline year and performance data adjusted; for the adjustments we make, refer to Climate-related metrics, targets and goals beginning on page 52 in the BHP Annual Report 2024.
8. CY2008 was selected as the baseline year for this goal to align with the base year for the International Maritime Organisation’s CY2030 emission intensity goal and its corresponding reasoning and strategy. Baseline and performance data have been adjusted to only include voyages associated with the transportation of commodities currently in BHP’s portfolio due to the data availability challenges of adjusting by asset or operation for CY2008 and subsequent year data. GHG emissions intensity calculations currently include the transportation of copper, iron ore, steelmaking coal, energy coal, molybdenum, uranium and nickel. Baseline and performance data have also been adjusted for a methodology change to use maritime transport emission factors from EU Regulation 2023/1805, after The British Standards Institution EN 16258 standard (the source of the emission factors we previously used) was withdrawn in CY2023.
9. Excluding in-kind contributions.
10. Area under stewardship that has a formal management plan that includes conservation, restoration or regenerative practices. 1.62 per cent is calculated based on the areas of land and water that we stewarded at 30 June 2024, as per footnote 4. For more information refer to the BHP ESG Standards and Databook 2024 available at [bhp.com/sustainability](https://bhp.com/sustainability).
11. Natural capital accounts are a way to measure the amount, condition and value of environmental assets in a given area. They help describe changes in ecosystems and how these impact wellbeing and economies.
12. Point in time data at 30 June 2024.
13. 8.3 per cent refers to Indigenous employee participation at Minerals Australia operations. Total Indigenous employee participation in Australia, including non-operational roles (1.9 per cent), was 7.5 per cent at 30 June 2024.
14. 11.2 per cent refers to Indigenous employee participation at the Jansen potash project and operation in Canada.
15. 10.1 per cent refers to Indigenous employee participation at Minerals Americas operations in Chile.
16. Since publishing our FY2023 scorecard, we have updated the methodology we use to track our ‘Progress to plan’ key metric and this change is reflected in our FY2024 performance against this metric. We had previously intended the metric would be Indigenous partner-measured (using a traffic light score) on satisfaction in relation to the milestones agreed in relevant partnerships, as co-designed in our regional Indigenous Peoples Plans. This update clarifies our intention to report on ‘Progress to plan’ in relation to our progress against the current or planned regional Indigenous Peoples Plans in Australia, Canada and Chile. The updated methodology for this metric aligns with the reporting methodology for the finalised regional plans, including the Australian Reconciliation Action Plan (RAP) published in May 2023 and the Canada Indigenous Partnerships Plan (CIPP) approved in June 2024 and published in August 2024, both of which will report on progress against the milestones co-designed in each plan. Australia is the only region with data available to report on its first year of progress against the RAP in FY2024, therefore the social value scorecard metric for Australia is considered ‘on track’ for FY2024. The first progress report for Canada on our co-designed CIPP will be made in our Annual Report 2025. We are still developing our regional Indigenous Peoples Plan for Chile. We have retained the Indigenous partner-measured methodology for measuring the ‘Present relationship health’ key metric. For more information refer to OFR 6.12 and the BHP ESG Standards and Databook 2024 available at [bhp.com/ESGStandards2024](https://bhp.com/ESGStandards2024).
17. Indigenous partners who participated in the relationship health check project in FY2024 considered and provided feedback on social, cultural and commercial aspects of their relationship with BHP and provided a rating on a 0–10 scale on the present health of their relationship with BHP – 0 is very poor, 5 is average and 10 is very good. For more information refer to OFR 6.12.
18. Reduction in life-altering injury or illness includes life-altering or long-term permanent disabling injuries and illnesses as defined by BHP’s Risk Framework. Since we commenced measuring our life-altering injury and illness metric, we have learned that a longer measurement period is required for analysis to allow for the classification of more chronic conditions. Therefore, it will not be reported on in this Report or included as a key metric in the social value scorecard in FY2025. This reflects a change from what we proposed in our FY2023 social value scorecard and so we have retained this metric in our FY2024 scorecard (without reporting against it) to explain the change in approach. The two main illness and injury types that influence life-altering injury or illness for BHP are musculoskeletal cases and noise-induced hearing loss cases, both of which we report on in OFR 6.7.

19. Co-design requires meaningful engagement and contribution to the plan from a variety of interested stakeholders. For an overview of our approach to co-design and co-creation (terms which we use interchangeably) refer to OFR 6.11.
20. This includes contribution to suppliers, wages and benefits for employees, dividends, taxes, royalties and voluntary social investment. For more information refer to the BHP Economic Contribution Report 2024.
21. Net Promoter Scores (NPS) show respective feedback from our customers and suppliers, and measure the willingness of our customers/suppliers to recommend BHP to others. NPS is used as a proxy for gauging overall satisfaction.
22. This milestone was achieved by developing a Group-level framework for nature-positive plans to achieve the 2030 Healthy environment goal (BHP Healthy environment goal roadmap).
23. Refer to OFR 6.10 for more information regarding the BHP Healthy environment goal roadmap.

## 6.6 People

Our more than 90,000 employees and contractors around the world are the foundation of our business. We aim to attract and retain the best people and our distinctive way of working through the BHP Operating System (BOS) seeks to empower our people to bring the best of themselves to improve their work every day.

Our Values set the tone for our culture and are a unique part of our competitive advantage. Our Values are a declaration of what we stand for and are designed to guide our behaviour and decision-making, as we work together in the pursuit of delivering on our purpose. In today's dynamic, uncertain world, anchoring our decision-making to a clear set of values remains as important as ever. In FY2024, we engaged with employees, partners and other stakeholders as we sought to redefine Our Values in a way that builds upon our rich history, while also reflecting BHP today. Our refreshed Values were launched in May 2024. They are simple and designed to enable our people to be ready to move quickly and deliberately to create and act on opportunities and navigate challenges as they arise. Our refreshed Values are:

### Do what's right

A sustainable future starts with safety and integrity, building trust with those around us.

### Seek better ways

Listening to learn and inspiring challenge is how we drive progress.

### Make a difference

The accountability to act, create value and have impact is on each of us, every day.

### Developing our capabilities and an enabled culture

We invest in the development of our people to build capability and drive stronger performance.

In support of work to deliver the capabilities for today and tomorrow, BHP's FutureFit Academy (located in Western Australia and Queensland) provides a pathway for new employees, some of whom have never worked in our industry before, to join Minerals Australia through an accredited maintenance and production traineeship or a trade apprenticeship. Once trained and qualified, employees move to one of our Australian assets. The strong partnership between vocational educational institutions and our FutureFit Academy facilitates the provision of nationally accredited qualifications and is a unique attraction and retention lever for BHP.

The FutureFit Academy is designed as an inclusive learning environment, welcoming employees who are new to the industry and providing permanent employment from day one. As at the end of FY2024, our student cohort included 80 per cent female participation and was made up of over 20 per cent Indigenous intake.

The FutureFit Academy expanded in FY2024 to provide a larger footprint in Perth, Western Australia, moving to a purpose-built learning centre that includes fabrication and auto electrical trades in addition to the core mechanical fitting and heavy diesel programs. A satellite FutureFit Academy was also established in Newman, Western Australia, providing a belt splicing program for experienced students.

Our intern and graduate programs also serve to attract and develop emerging talent for critical skills we need for the future. In FY2024, we had 60 first-year university students participate as part of our First-Year Internship Program across Australia. The program aims to boost enrolments in Australian resource-related tertiary degrees by exposing science and engineering students to mining careers. In FY2024, an additional 147 university students joined the BHP Internship Program for five to 24 weeks to gain experience in their chosen field of study through on-the-job learning, working on mine sites alongside technical professionals. Our selected interns have early access to apply for our annual graduate program intakes. In FY2024, we onboarded 177 employees into our graduate program across Australia, Chile, Canada, Singapore and the United States, to meet the needs for future skills across our operations and functions in those regions.



To support our focus to build leader capability and drive stronger performance, we conduct multi-level leadership development programs. The Senior Leadership Forum is intended to develop senior leaders through shared goals and context. In FY2024, this forum was delivered quarterly with a summit held in late FY2024 to further engage our senior leaders in relation to our purpose, strategy and operating system, and to launch the refreshed Our Values. Additionally, we also continue to facilitate an Integrated Leadership Forum for general managers on a quarterly basis to align this next critical cohort of leaders. Further, around 2,000 leaders including supervisors, superintendents and managers attended BHP Distinctive Leaders programs in FY2024, focused on developing their ability to lead inclusively, ethically and through complexity.

We ask our employees and contractors about their experiences working with BHP via an Engagement and Perception Survey twice a year. After each survey, our team leaders assess what is working well and what they can learn from others before taking action to address improvement areas. Additionally, this survey is used to measure progress against a wellbeing metric within the Safe, inclusive and future-ready workforce pillar in our social value scorecard. In March 2024, we had a response rate of 82 per cent of employees, with 24,000 contractors also providing feedback. We achieved a strong result, with 80 per cent of participants responding favourably to questions related to their engagement and connection to BHP and 87 per cent to questions related to their wellbeing.

### **Inclusion and diversity**

We believe an inclusive and diverse workforce promotes engagement, safety and productivity, and is valued by prospective employees as well as our current workforce.

Our Inclusion and Diversity Position Statement confirms our vision, commitment and contributions to inclusion, equity and diversity. Since 2016, we have been embedding flexible working, ensuring our facilities and equipment are purpose-fit by partnering with our supply chain partners, and undertaking work to mitigate bias in our systems with the aim of creating workplaces that are safe and inclusive for a diverse range of people.

Our goal is to attract and retain a workforce that is representative of society. We do this by implementing measures designed to address the barriers and impacts of bias and discrimination experienced by people within underrepresented groups, through listening to their experience and gaining insights from our engagement surveys and our voluntary self-identification survey, 'Tell Us About You'. As of February 2024, over 11,000 of our employees had completed the survey.

We also recognise pay is a critical mechanism for creating gender equality. To help mitigate gender pay disparities and prevent the creation of pay gaps, we continue to drive improvements in our systems and processes to remove systemic bias. As an example, our recruitment processes include a 'blind reward' process, which is designed to reduce potential bias in remuneration offers at the time of hire. We use global best practice methodologies to calculate the pay gap between men and women in like-for-like or comparable roles. We analyse our pay data and conduct gender pay equity reviews at least annually. The results of the pay equity reviews are reported to the BHP People and Remuneration Committee. Our FY2024 employee remuneration data, including a breakdown by gender, is available in the ESG Standards and Databook 2024.

### **Gender balance<sup>1</sup>**

In CY2016, we announced our aspiration to achieve gender balance within our employee workforce globally by the end of CY2025, which we define as a minimum 40 per cent women and 40 per cent men. This has also been included as one of the key metrics we measure progress against our Safe, inclusive and future-ready workforce pillar in our social value scorecard.

We increased the participation of women working at BHP in FY2024 by 1.9 percentage points compared to FY2023, with around 10,500 more female employees at the end of FY2024 than FY2016. As at 30 June 2024, women represented 37.1 per cent of our employee workforce. Since we first set our gender balance aspiration in 2016, BHP has more than doubled the participation of women (from 17.6 per cent to 37.1 per cent). We also reached a significant milestone during FY2024 achieving over 40 per cent participation of women in our employee workforce across the Minerals Americas operations in Chile, and as at 30 June 2024 this was 40.9 per cent.

The gender breakdown of new hires in FY2024 was 48.1 per cent men and 51.9 per cent women. We improved our participation of women in leadership in FY2024 by 2.0 per cent compared to FY2023. As at 30 June 2024, 31.7 per cent of people leaders were women and of our senior executives 40.9 per cent were women and 59.1 per cent were men.

For operational teams, a focus on roster and job redesign is designed to support greater female participation. Our Bamboo flexible work program is an example of this.

### **Footnotes**

1. Based on a 'point in time' snapshot of employees as at 30 June 2024, including employees on extended absence, as used in internal management reporting for the purposes of monitoring progress against our goals. New hires is based on a 12-month period from 1 July 2023 to 30 June 2024. 'People leaders' are defined as employees with one or more direct reports. 'Senior executives' are defined as employees in the Executive Leadership Team (ELT) and direct reports to the ELT in grade 15 and above roles. Figures reported do not include employees of BHP Mitsubishi Alliance's Blackwater and Daunia operations, sold to Whitehaven Coal during FY2024.

### *Case study – Bamboo flexible work program*

In FY2024, our Bamboo flexible work program was a finalist in the Chamber of Minerals and Energy of Western Australia Women in Resources Awards. Founded in 2019 at Newman Operations, the Bamboo program is a residential gender diversity initiative that supports the attraction and retention of women in historically male-dominated roles. The Bamboo program is targeting an 80 per cent female intake from the Newman township, creating an opportunity for new-to-industry and existing workers to have flexible work options with reduced shift hours, enabling them to actively maintain a career in mining production, specifically haul truck operations.

### Gender composition of employees, leaders and the Board<sup>1,2,3</sup>



1. Based on a 'point in time' snapshot of employees as at 30 June 2024, including employees on extended absence, as used in internal management reporting for the purposes of monitoring progress against our goals. For FY2024, this does not include employees of BHP Mitsubishi Alliance's Blackwater and Daunia operations, sold to Whitehaven Coal during FY2024.
2. For FY2023, this did not include employees that transitioned from the OZ Minerals business via acquisition on 2 May 2023 (359 female employees and 1,098 male employees at 30 June 2023).
3. For FY2023, some of our employees did not identify as male or female (<0.1 per cent of total employees). These employees were excluded from data presented in the gender composition graphs to protect the privacy of those employees.

#### Indigenous employment

Indigenous peoples are critical partners of BHP across our operations. We recognise, as part of our global Indigenous Peoples Policy Statement, we can contribute to the economic empowerment of Indigenous peoples by providing opportunities for employment, training and procurement and by supporting Indigenous enterprises.

We have set targets to increase Indigenous employment in our Minerals Australia operations, Minerals Americas operations in Chile and our Jansen potash project in Canada.

## Indigenous employee participation<sup>1</sup>



> For more information on our 2030 goals related to Indigenous partnerships refer to 6.12

### Racial equity program

There is no place for racism at BHP or anywhere in the community. We recognise and acknowledge racism impacts our people’s sense of identity, value, feelings of respect and psychological safety. We are taking action to better understand the prevalence of racism at BHP to promote racial awareness and equity in our workplace, and we recognise there is more still to do.

We continue to take action to increase awareness of and promote reporting, response and investigations in relation to racial harassment matters. In FY2024, across our global operations and offices:

- 109 reports of racial harassment were received into BHP’s reporting channels for raising misconduct concerns.
- 42 per cent of the reports received were logged by leaders, on behalf of others.
- 23 investigated cases of racial harassment conduct were established as having occurred.
- Of the 23 established cases, 21 individuals responsible had their employment terminated (or were removed from site if a contractor) or resigned.
- 19 reports of racial harassment were dealt with by a non-investigative resolution pathway at the impacted person’s request.

Our racial equity working group is led by Chief Financial Officer Vandita Pant as the executive sponsor and oversees work with a focus on eliminating racism and striving to create an environment free from racial discrimination. As part of its work, this group works alongside our Indigenous engagement teams in Australia, Chile, Canada and the United States.

Throughout FY2024, we continued to progress our work in identifying and addressing structural barriers to equity, and in building awareness and capability in our leaders. We also continued to improve our grievance processes to better support people who tell us when they have experienced racism. Our work in FY2024 included:

- commencing the refresh of a central online platform called RespectHub, including the development of a new virtual assistant RespectChat, aimed at providing information and tools to our workforce to prevent and respond to racism, including support options, response pathways and reporting

- launching new chapters of EmBRace (Employees Beyond Race), our employee resource group focused on discussions around race and racial diversity. Local chapters have now been set up in Canada and South Australia, in addition to existing chapters in Western Australia, Queensland, Singapore and Manila
- continuing our internal and external global awareness and communication campaign, the ‘people of BHP’ series, which aims to celebrate our diversity
- recording and launching a four-part podcast series on racial awareness, with a series of BHP leaders in conversation with external subject matter experts, to continue to support our people to develop a racially aware mindset
- signing up to the RISE Project run by Diversity Council Australia, to commence work in FY2025 to implement organisational change interventions that will help address systemic and organisational barriers for women from culturally and racially marginalised (CARM) backgrounds

### **LGBT+ inclusion**

Our LGBT+ ally employee inclusion group, Jasper, established in 2017, is a natural extension of our inclusion and diversity aspirations. Its membership base grew to around 2,900 at the end of FY2024, with 16 chapters globally.

In FY2024, we continued to advocate for LGBT+ inclusion and partner with charities throughout the communities where we operate, to help our LGBT+ employees develop a strong sense of belonging inside and outside of our offices and our mine sites.

In FY2024, BHP in Chile was recognised by the Human Rights Campaign (HRC) with certification under the HRC Equidad CL program as one of the ‘Best Places to Work LGBTI+ 2024’. The certification in Chile is delivered by HRC, Pride Connection and Iguales Foundation and is awarded based on a benchmark assessment of a company’s measurable workplace equality and inclusion efforts for the LGBTI+ community.

### **Disability**

To foster a workplace where people with a disability can fully participate and thrive, during FY2024 we progressed the development of our first global Disability Action Plan, which is expected to be launched during the first half of FY2025. The plan seeks to address three strategic pillars – people, culture, systems – to encourage, recognise and promote an active commitment to improving accessibility and disability inclusion.

Though we are early in this journey, recognising that everyone has unique needs and strengths, our ambition is to address and remove barriers so that people with a disability can equitably participate in our workforce.

### **Employee relations**

In Australia, the Federal Government has introduced several tranches of significant industrial relations legislative reforms. In June 2023, this included the introduction of changes to the enterprise bargaining framework with multi-enterprise bargaining. During FY2024, the Federal Government enacted the ‘same job same pay’ policy, enhanced workplace delegates’ rights and empowered the Fair Work Commission to make workplace determinations in the case of intractable bargaining. Not all the legislative reforms have fully commenced operation and we will continue to monitor how they are applied to further our assessment of impacts on BHP and our contracting partners, including the potential to increase labour costs.

In Chile, the 40-hour week regulation was enacted in April 2023 and requires a gradual implementation over the next five-year period to move from 45 to 40 working hours per week. During FY2024, implementation commenced for the collective agreements that were completed, which now include mandatory shift reductions to 42-hour weeks in April 2026 and 40-hour weeks by April 2028. We continue navigating and monitoring progress on a number of legal developments that may have implications for employee relations in Chile, for example, pension reform and branch negotiation regulation.

During FY2024, Minerals Australia participated in 11 collective bargaining processes, with seven enterprise agreements completed (with 23 presently in operation) and four subject to ongoing negotiations as at 30 June 2024. In Minerals Australia, there was one round of collective bargaining where protected industrial action occurred during FY2024 (BMACo OCO Enterprise).

Minerals Americas participated in four collective bargaining processes during FY2024, with three completed prior to 30 June 2024 and one concluded subsequent to 30 June 2024. No protected industrial action occurred during FY2024 at our Minerals Americas operations in Chile.

### **Payroll review**

#### **Review of employee allowances and entitlements**

In FY2023, we identified and disclosed two issues with certain allowances and entitlements affecting some current and former employees in Australia. We self-reported these issues to Australia’s Fair Work Ombudsman (FWO) and engaged Protiviti, a global assurance firm, to undertake a review of our payroll systems. We are sorry that this has happened and we are working to make this right.

We continue to progress historical remediation of both issues. We have a dedicated hotline and secure online portal in place to support impacted current and former employees and facilitate remediation payments. We encourage any former employees who think they may be impacted by these issues to contact us via the hotline or portal.

**> [Refer to our website bhp.com/payroll-review](https://www.bhp.com/payroll-review)**

The first issue involves certain rostered employees having leave incorrectly deducted on public holidays. OZ Minerals was affected by a similar issue before being acquired by BHP in May 2023. At the end of July 2024, we had identified approximately 35,500 current and former employees who are affected by this issue, dating back to 2010. Progress on remediation includes:

- crediting leave hours to approximately 19,000 current employees, including employees who had been affected by a similar leave deduction issue at OZ Minerals, before it was acquired by BHP in May 2023
- payments made to approximately 7,500 former employees impacted by this issue, including those who had been affected during a prior period of employment at OZ Minerals
- ongoing endeavours to connect with approximately 9,000 former employees who we have identified as eligible for a payment but have not yet been able to locate with the contact information we have

We aim to complete the majority of public holiday leave deduction payments by the end of FY2025.

The second issue involves current and former employees at Port Hedland in Western Australia Iron Ore (WAIO) who are entitled to additional allowances due to an error with their employing entity in their employment documentation. Following detailed analysis, we have identified approximately 230 current and former employees affected by this issue, dating back to 2013. We are continuing to pay additional allowances to affected current employees. We are also progressing payments to affected current and former employees for historical impacts.

Based on the currently available information, the cost of remediating the leave issue and the employing entity issue, incorporating on-costs, including associated superannuation and interest payments (BHP share), remains in line with the previously recognised US\$280 million pre-tax, as reflected in the Group's FY2023 financial results.

**Improving our payroll systems and processes**

In FY2023 we engaged Protiviti to conduct a review of BHP's payroll systems and framework, including governance, processes, controls and systems. Protiviti's review is ongoing. We are progressing a range of work to improve our global payroll systems and processes, including embedding stronger governance, controls and processes and continuing to invest in the right capabilities to meet the needs of our broad operations and workforce into the future. We expect this work to continue over the next few years.

We will continue to engage with the FWO and other relevant government agencies as we progress this work.

The Board and CEO have taken these issues seriously and a range of consequences have been implemented for employees in connection with these issues. Specifically, the Board has determined that the CEO's FY2024 CDP outcome will include a 4.3 percentage point reduction to reflect his ultimate accountability for BHP's payroll systems. This CDP reduction for the CEO in FY2024 is US\$185,000 and is equivalent to 25 per cent of the CEO's target annual short term incentive pro-rated for the portion of the relevant period that he was CEO. For others with accountability for BHP's payroll issues (including current and prior ELT members) there have been reductions determined in the variable remuneration outcomes ranging between 25 per cent to 100 per cent of relevant annual target variable pay.

Other consequences have ranged from letters of warning, remuneration consequences and termination of employment.

Further detail is provided in the Remuneration Report.

## Sexual harassment

The safety of our employees and contractors is paramount. Our priority is to ensure our workplaces are safe and inclusive for all and to enact our culture of care. This includes the elimination of sexual harassment, which we recognise is unequivocally unacceptable. We encourage our people to be active bystanders through education and leadership role modelling and to report incidents so we can provide appropriate support and more effectively address and eliminate sexual harassment at BHP.

In FY2024, BHP's strategy to eliminate sexual harassment was underpinned by the Australian Human Rights Commission Guidelines for Complying with the Positive Duty under the Sex Discrimination Act 1984 (Cth). Our strategy was also informed by external experts, such as Kristin Hilton, Kate Jenkins AO along with Queensland University of Technology. The strategy seeks to prevent sexual harassment by addressing the drivers and risk factors and enhancing our response to incidents, early intervention and taking a person-centred response by increasing support and agency for impacted persons. We acknowledge how sexual harassment interacts or combines with other psychosocial hazards and we have sought to address this in the way we approach prevention through holistic risk management.

## Risk management

Sexual harassment has been defined as a material health and safety risk at BHP since CY2018. Our risk management approach includes conducting risk assessments to identify scenarios in which sexual or gendered harassment may arise, their potential causes and the controls we can implement to prevent and reduce harm. This recognises the high intersectionality with other psychosocial risks, which can increase the likelihood of sexual harassment occurring and the severity of harm it can cause. We acknowledge there are factors that contribute to the likelihood of workplace sexual harassment that are more pronounced in the mining industry. This includes isolated or remote working locations, a historically male-dominated workforce and accommodation villages, roles and equipment design as well as factors that are common across all industries and workplaces.

Our FY2024 focus was on implementing additional prevention controls informed by our data and organisational learnings across all assets and offices, including review and recommendations from third-party experts. Our sexual harassment prevention controls are associated with further education and maintaining respectful behaviours; leadership and culture; recruitment processes; security measures at accommodation villages; contractor and third-party engagement; data transparency and action; person-centred care for impacted persons; accessible confidential reporting; trauma-informed response and investigations, including multiple resolution options and pathways; and appropriate and proportionate disciplinary action.

## Culture, knowledge and leadership

We are committed to fostering a positive culture that is safe, respectful and inclusive for all workers (employees and contractors) and supports gender equality and diversity at all levels and across all areas. Gender balance is a key protective factor for sexual harassment prevention and BHP aspires to have a gender-balanced employee workforce by end of CY2025.

In FY2024, we continued to engage and empower our entire workforce to take action as active bystanders by enhancing their capabilities to identify and call out disrespectful behaviour through scenario-based learning. BHP strives to ensure leaders understand their obligations to prevent sexual harassment and are visibly committed to safe, respectful and inclusive workplaces through setting clear expectations and role modelling respectful behaviours.

## Support and reporting

We encourage our workforce to report any concerns relating to potential sexual harassment, including by providing centralised and confidential reporting tools and mandatory reporting requirements for line leaders. Impacted persons are offered a range of support options throughout and beyond the process to resolution.

Investigations of reports of sexual harassment are conducted by our specialised Response and Investigations team, which is independent from our other business units. This team includes experts trained in a person-centred, trauma-informed approach to help place the impacted person at the centre of decisions made during the investigation process and to minimise the risk of further harm to that individual.

Alternatively, resolution pathways can be used in certain cases. This process only occurs where the resolution pathway is proportionate to the nature of the conduct and with the agreement of the impacted person. The resolution pathways include supported conversations with respondents, additional training, monitoring or awareness raising on BHP's expectations of respectful behaviours in the workplace. We continue to monitor and review the use of our resolution pathways to assess whether they are meeting the needs of impacted people and to improve reporting to support organisational lessons learned.

## Measuring

We measure our progress against our initiatives and key metrics for sexual harassment prevention and response, such as training completion, risk management, control implementation and effectiveness, engagement results and misconduct reporting data, and are committed to continually improving our approach. De-identified information and trend analysis data on the number of complaints, nature of complaints, resolution pathways, outcomes and timelines are provided to senior leadership and the Board to raise awareness and support continuous improvement of how we prevent and mitigate the impacts of sexual harassment at BHP.

**>For more information on how we are improving our approach to the prevention of and response to sexual harassment refer to [bhp.com/sustainability/safety-health/sexual-harassment](https://bhp.com/sustainability/safety-health/sexual-harassment)**

## Reports of sexual harassment

There were 417 reports of sexual harassment in FY2024. These behaviours are unacceptable and we are working to eliminate them at BHP by increasing awareness and promoting reporting, response and investigations in relation to these matters. Since October 2020, BHP managers and leaders have been required to enter any misconduct concerns raised directly with them into BHP's misconduct reporting channels<sup>1</sup> (with the impacted person remaining anonymous if requested). In FY2024, 42 per cent of sexual harassment reports received into BHP's misconduct reporting channels were logged by managers or leaders on behalf of their direct reports.

During FY2024, across BHP's global operations (including off site) and offices, 100 investigated cases of sexual harassment<sup>2</sup> conduct were established as having occurred through an investigation.<sup>3</sup>

Of the 100 established cases:

- 1 involved a sexual assault
- 22 involved sexualised and indecent touching
- 32 involved sexually aggressive comments, stalking, grooming or image-based harassment
- 45 involved other forms of sexual harassment, including sexualised conversations or jokes
- 103 individuals responsible had their employment terminated (or were removed from site if a contractor) or resigned

In addition to the matters listed above, in FY2024 60 reports of sexual harassment were dealt with by way of non-investigative resolution pathways, instead of an investigation being conducted. In addition to non-investigative resolution pathways, there are cases of sexual harassment that cannot be investigated due to insufficient information or the wishes of the impacted person. Examples include anonymous reports and non-participation of the impacted person. However, all cases are assessed for safety and impacts as part of preliminary investigative actions and all participants (if identified) are offered support irrespective of whether the matter can be formally investigated.

**>For more information on how we are improving our approach to the prevention, response, support and measuring of sexual harassment refer to [bhp.com/sustainability/safety-health/sexual-harassment](https://bhp.com/sustainability/safety-health/sexual-harassment)**

## Footnotes

1. BHP's channels to raise misconduct concerns comprise an online portal and 24-hour multilingual call service. Reporting channels are confidential and accessible to all, including external partners and stakeholders and the public, to report conduct that may be unethical, illegal or inconsistent with *Our Code of Conduct*.
2. Sexual harassment is, as defined in the Sex Discrimination Act 1984 (Cth), an unwelcome sexual advance, unwelcome request for sexual favours or other unwelcome conduct of a sexual nature, in circumstances where a reasonable person would have anticipated the possibility that the person harassed would be offended, humiliated and/or intimidated. Sexual harassment encompasses a range of conduct, including displaying sexually graphic images, sexually suggestive comments, suggestive or inappropriate looks, gestures or staring, non-consensual touching or acts of a sexual nature and sexual assault. We note the definition of sexual harassment may vary in different jurisdictions.
3. The calculation is based on reports closed in FY2024, containing one or more established allegations. Not all reports resulted in a finding. This can occur if there is insufficient information, the respondent is not able to be identified or was previously terminated, or the impacted person did not wish to proceed. This figure includes cases opened in FY2024 and prior to FY2024 that were closed during the reporting period. When referring to cases closed during FY2024 this excludes cases that were still open at the end of the reporting period.

## 6.7 Health

We set mandatory minimum standards to identify, assess and manage health risks and their potential impacts, and monitor the health of our employees and contractors.

### Occupational exposures

BHP follows the hierarchy of controls to reduce occupational exposures to as low as reasonably practicable. Our mandatory minimum performance requirements for risk management and our Risk Framework support the identification and management of occupational exposures. Where there is a potential for our employees and contractors to be exposed to chemical and physical hazards in workplace atmospheres, we implement controls intended to prevent, minimise, and/or mitigate the likelihood and severity of potential associated health impacts. These actions may include the use of respiratory protective equipment until appropriate, higher-order controls have been identified, implemented and verified to consistently reduce exposure below occupational exposure limits. Occupational exposure limits indicate the level of permissible exposure for a length of time (usually eight hours) to a chemical or physical hazard that is not likely to affect the health of a worker. Occupational exposure limits for our most material exposures are set according to the latest scientific evidence.

Exposure data in this Report in all cases is presented without considering protection from the use of personal protective equipment where required, as outlined in our *Health Global Standard*.

In FY2024, for our most material exposures of diesel particulate matter (DPM) and respirable silica, we had a 46 per cent reduction in the number of employees and contractors potentially exposed compared to our FY2023 exposure profile. More specifically, we have recorded a 23 per cent reduction in the number of employees and contractors with potential exposure to DPM and 54 per cent reduction in the number of employees and contractors potentially exposed to respirable crystalline silica. When exposure reduction is considered over the last six years, we have achieved a 78 per cent reduction to our most material exposures. We continue to have zero employees and contractors routinely exposed to coal mine dust above the occupational exposure limit. We are currently undertaking a baseline exposure monitoring program at the former OZ Minerals Australian assets and will provide a comparable exposure profile in FY2025.

Exposure reduction trend over time<sup>1,2,3,4</sup>

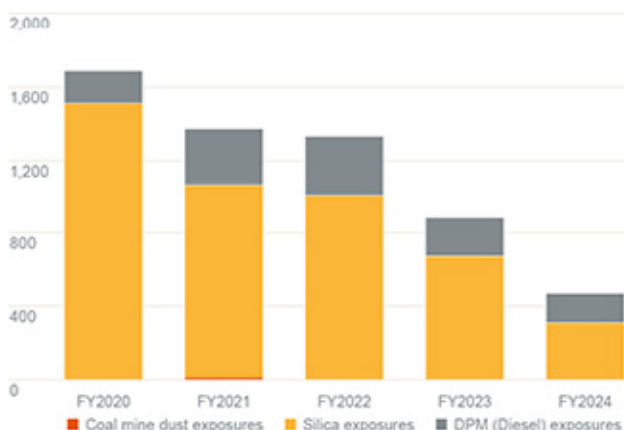

**Footnotes**

1. Data excludes Discontinued operations as follows: BHP Mitsui Coal (sale completed on 3 May 2022) and BHP’s oil and gas portfolio (merger with Woodside completed on 1 June 2022). Prior years’ data (FY2020 to FY2022) has been re-stated to exclude these operations. Divested DMA assets, Daunia and Bllackwater (divested on 2 April 2024) are included in FY2024 data up until the date of divestment.
2. Occupational exposures data excludes Projects.
3. Occupational exposure data excludes assets acquired as part of the OZ Minerals acquisition. We are currently undertaking baselining of exposure data to provide comparable exposure profile in FY2025.
4. As of FY2021, the occupational exposure limit for Coal was reduced to 1.5 mg/m<sup>2</sup> compared to 2.0mg/m<sup>3</sup> in previous years.

We are committed to having no AL4 (fatalities and life-threatening illnesses) events and a reduction in life-altering injuries and illnesses. Due to the latency between initial exposure and diagnosis of disease for our most material airborne contaminant exposures, we must demonstrate ongoing exposure reduction and effectiveness of controls, where exposures may remain elevated. In FY2023, reduction plans were developed at the asset level across operations for implementation with priority afforded to the asset’s most material exposures. The implementation of these exposure reduction plans commenced in FY2024 and will continue to be a focus in FY2025.

Welding fume exposure control has been a particular focus for several assets across BHP throughout FY2024. Additional controls, including on-torch extraction systems and portable local exhaust ventilation systems have been implemented at Olympic Dam. Control effectiveness testing has been carried out by the local Occupational Hygiene team, indicating a 50 per cent reduction in welding fume exposure since September 2022. Due to the success of this project, additional similar controls are now being trialled in some of our other operations, including WAIO, at Mining Area C, Jimblebar and Mt Whaleback.

Occupational exposure hazard awareness and training is provided at induction and periodically, including during fit testing for hearing protection and respiratory protective devices. Wherever workers take part in occupational exposure assessment programs, they receive written feedback on their results and anonymised data is provided to line management.

We have implemented real-time monitoring at several of our Minerals Australia and Minerals Americas operated assets to support further exposure reduction of silica and DPM. Fixed-position monitors identify dusty conditions in real time enabling immediate controls, such as increased ventilation or water sprays, to be deployed. Data from portable monitors is made available at the end of shifts, rather than when results of samples sent to the laboratory for analysis become available. This enables prompt action to be taken if real-time monitoring demonstrates an increasing trend in potential exposure.

**Occupational illness**

The reported occurrence of occupational illness for employees in FY2024 was 270, which was 3.77 per million hours worked. This represented a 13 per cent decrease in incidence compared with FY2023, which was 4.35 per million hours worked. For our contractor workforce, the reported occupational illness in FY2024 was 216, which was 1.79 per million hours worked, representing a 10 per cent decrease in incidence compared with FY2023, which was 1.99 per million hours worked.

As noted in our FY2024 performance against our social value scorecard provided in OFR 6.5, BHP is committed to reducing life-altering injury or illness and we continue to track the number of life-altering injuries and illnesses internally. Since we commenced measuring our life-altering injury and illness metric, we have learned that a longer measurement period is required for analysis to allow for the classification of more chronic conditions. Therefore, it will not be reported on in this Report or included as a key metric in the social value scorecard in FY2025. The two main illness types that influence the number of life-altering illnesses are musculoskeletal cases and noise-induced hearing loss cases, both of which we continue to report on annually. Information relating to injuries can be found in section 6.1.



Musculoskeletal illness is the predominant occupational illness category for BHP employees and contractors, representing 68 per cent of our workforce illnesses in FY2024. These conditions include damage to bones, joints, ligaments, tendons and soft tissues, caused by repetitive heavy work, muscular strain, or maintaining poor postures for extended periods of time.

Noise-induced hearing loss represents 8 per cent of occupational illnesses in FY2024. Employees and contractors exposed to noise levels above the defined workplace exposure limits in our *Health Global Standard* participate in hearing conservation programs, which include a periodic hearing test and hearing protection fit testing. We have established design recommendations that seek to eliminate or reduce high or prolonged noise exposures by focusing on noise source.

Heat stress contributed to 4 per cent of our reported occupational illnesses in FY2024. Elevated temperatures and strenuous activity place some of our workforce at an increased risk of heat illness. High-risk work groups are identified, and a range of controls are in place to manage heat stress. In FY2024, a new heat awareness online learning module was released for workers across Minerals Australia to provide workers with the knowledge to identify signs of heat illness and how to manage the risks associated with working in the heat. Hydration testing has also been made available at several operations with high heat risk.

Recognising climate change may exacerbate existing temperature related risks, in FY2024 we piloted an approach at Olympic Dam to better understand and quantify the potential impact of heat stress on our workforce under different future climate scenarios. Modelling was based on climate data and temperatures within the underground mine to determine potential productivity and health impacts caused by heat stress under different scenarios. The findings of this assessment will assist in the identification of additional controls that may be required to ensure our workforce can perform their roles safely under changing climatic conditions.

### **Coal mine dust lung disease**

In FY2024, 21 cases of coal mine dust lung disease (CMDLD)<sup>1</sup> were reported to the Workers' Compensation Regulatory Services.<sup>2</sup> Of the 13 accepted claims in FY2024, two were current BHP employees, while the remaining 11 were former employees. For cases involving current employees, we offer counselling, medical support, and redeployment options where relevant. Former employees are eligible for workers' compensation insurance and associated care is managed externally to BHP.

We have controls in place across all our relevant operated assets with the goal of ensuring none of our employees and contractors are exposed to respirable CMD above the occupational exposure limit (OEL). We continue to identify and progress projects, such as real-time dust monitoring, to facilitate our recognition and action when the working environment may present a health hazard and seek to implement high order controls, such as engineering controls to eliminate or reduce exposures rather than continued reliance on lower order controls, such as respiratory protection. We have observed consistent control of CMD exposures with no employees or contractors potentially exposed to CMD above the OEL since FY2021.

### **Footnotes**

1. CMDLD is the name given to the lung diseases related to exposure to coal mine dust and includes coal workers' pneumoconiosis, silicosis, mixed dust pneumoconiosis and chronic obstructive pulmonary disease.
2. Cases reported to Workers' Compensation Regulatory Services are not an indication that the CMDLD was related to work. BHP evaluates each case for work-relatedness and where identified, the case will be included in occupational illness reporting.

### **Physical and mental health**

The physical and psychological health and wellbeing of our workforce is of paramount importance as we continue to work towards enhancing the inclusivity and future-readiness of our employees and contractors. In FY2024, we continued efforts to make meaningful and positive improvement to employee health and wellbeing by building stronger relationships via our active collaborations with industry partners. We engaged with initiatives such as the 'Minding Mining Minds' (MMM), which aims to develop tools and evidence-based models and share learnings across industry, the Building Safe and Respectful Workplaces (BSRW) which aims to help eliminate disrespectful behaviour in the resources industry including sexual harassment, bullying and racism and we have an active partnership with the Global Business Collaboration for better mental health.

Our focus internally has been on embedding our learnings. In FY2024, we embedded the BSRW principles into our global onboarding. A Global Wellness Committee was also established, bringing together asset and corporate office Wellness Committees into a global forum to collaborate on initiatives, implement strategic improvements and share learnings. The Committee aims to build mental health literacy, increase awareness and benefit overall physical and mental wellbeing, and has maintained a strong ongoing participation in global health campaigns, such as BHP Mental Health Month, RUOK? day and Movember.

In FY2024, the Group Health team introduced the Women Can initiative to promote women's physical and mental health. The Women Can initiative ran during March, aiming to lift the profile and importance of women's health and wellbeing. Through prestart education packs, personal shares and panel discussions held with senior female leaders, including our Chief People Officer, and Group HSS Officer, BHP provided education and an opportunity for safe and impactful conversations on the importance of self-care, health screening, menopause and providing a safe and inclusive workplace. During this campaign, BHP formed a formal partnership with Menopause Friendly Australia and is working towards achieving accreditation as a menopause friendly employer where we aim to raise awareness, educate staff and engage in training and policy and process change to address women's health and menopause in the workplace.

### **Psychosocial risk management**

We continue to integrate psychosocial hazard identification and management into the way we work. Our employees and contractors are encouraged to identify and call out disrespectful behaviours that may contribute to psychological harm, including bullying and sexual harassment, as well as other psychosocial hazards.

Our Psychosocial Risk Assessment Program was established in FY2023 and initially focused on our operated assets. In FY2024, we completed psychosocial risk assessments across our global functions. From this work we have developed an organisation-wide psychosocial risk profile across five evidence-informed BHP-specific Psychosocial Hazard Domains – in interpersonal; traumatic; physical (distance and fatigue); organisational and job-inherent hazards. We will deploy these Hazard Domains to categorise and rank psychosocial hazards and identify controls for our most significant psychosocial hazards.

In FY2024, we developed and commenced the introduction of the BHP Psychosocial Health Index, which we will complete in FY2025. This is an assessment tool and confidential platform for employees and contractors to provide feedback on how they experience the physical and psychological aspects of their work environments, the social aspects of their job and the design and management of work, together with an associated measure of physical and mental health that helps us determine where harm may be occurring.

As part of our Psychosocial Risk Assessment Program, we have also expanded our support options, including providing additional pathways for employees and contractors to seek information and support on preventing and managing psychosocial hazards when they occur. We also expanded and simplified our tools and guidelines in FY2024, centralising them in one easily accessible hub and enabled 'in the moment' interactive support via a new digital tool.

#### *Support for employees affected by family and domestic violence*

BHP has a Family and Domestic Violence Assistance Program, which was updated in FY2024, that aims to provide employees with support for their health, safety, wellbeing and independence if they are experiencing family and domestic violence.

As part of the program, employees can access up to 10 days' additional paid leave if they are affected by family and domestic violence or supporting someone who is.

Support also includes emergency accommodation, emergency financial help and access to safety and security plans. These supports consider safety measures, such as transport to and from work, changing location of work, setting up new phone numbers, screening/blocking calls and emails, and supporting access to legal advice.

## **6.8 Ethics and business conduct**

### **Our conduct**

*Our Code of Conduct (Our Code)* is designed to help us make the right decisions every day and deliver on our purpose to bring people and resources together to build a better world. It applies to everyone who works for us, with us or on our behalf. To assist our employees and contractors understand how *Our Code* applies, regular training is undertaken. Breaching *Our Code* can result in serious consequences and depending on the severity of the breach this could include counselling, warnings and even termination of employment. We encourage people to speak up where a decision or action is not in line with *Our Code* or Our Values.

BHP requires reports of business conduct concerns to be treated with appropriate confidentiality and has policies in place intended to prohibit any kind of retaliation against people who make or may make a report, or who cooperate with an investigation. These may also include reports made to regulators. We consider all forms of retaliation to be misconduct and grounds for disciplinary action, up to and including termination. We have a number of key policy and process documents to support a safe to speak up culture, including our BHP Whistleblower Policy.

**>[Our Code is available in five languages and accessible at bhp.com/about/operating-ethically/our-code/](https://bhp.com/about/operating-ethically/our-code/)**

**>[Our BHP Whistleblower Policy sets out additional information, including protections available to persons who make eligible disclosures under Australian law and accessible at bhp.com/-/media/documents/ourapproach/operatingwithintegrity/taxandtransparency/240523\\_bhpwhistleblowerpolicy](https://bhp.com/-/media/documents/ourapproach/operatingwithintegrity/taxandtransparency/240523_bhpwhistleblowerpolicy)**

Reports received are assessed by the Ethics and Investigations team to determine an appropriate response, which may include an investigation or other resolution. In assessing the appropriate response, BHP applies a proportionate and person-centred approach to the report considering all participants. People impacted by reports of sexual harassment and racism are offered specialised support by the Ethics Support Service, which enables people impacted to have input into BHP's response. The impacted person's preferences as well as the type and severity of the alleged misconduct are considered in determining the appropriate response, which may include an investigation, training, facilitated conversations and line leader intervention. Quarterly reporting on the most serious reports is provided to senior leaders and the Risk and Audit Committee, which has representation of Board members, and includes reported case metrics, outcomes and insights. The reporting supports leadership awareness and informs priorities for ongoing improvement. Feedback is obtained regularly from stakeholders, including case participants, external experts and management, to continually improve our response to reports.

In FY2024, 5,087 reports regarding business conduct were received directly into BHP's channels to raise misconduct concerns.<sup>1</sup> Out of the total misconduct reports, 25 per cent were raised by leaders on behalf of someone else. There continues to be a great focus on health and wellbeing in the workplace, and we have seen a 6 per cent decrease of bullying and harassment cases from 3,067 in FY2023 to 2,870 in FY2024.

Of the business conduct reports received, 41 per cent were made anonymously.<sup>1</sup> Of the total business conduct reports closed during FY2024, 41 per cent contained one or more established allegations.<sup>2,3</sup>



\* Other: This includes issues such as Retaliation for speaking up; Deficiencies in a business conduct investigation; Failure to Report Code of Conduct Breach; Attempting to identify an anonymous reporter; Improper political or governmental conduct; Human rights or modern slavery; Ask a question; Trade control breach; Inappropriate investigator conduct in business conduct investigation; Consensual relationship with power imbalance.

### Footnotes

1. This excludes reports not containing a business conduct concern and excludes reports logged by leaders on behalf of others.
2. The calculation is based on reports closed in FY2024, containing one or more established allegations. Not all reports resulted in a finding. This can occur if there is insufficient information, the respondent is not able to be identified, was previously terminated, or the impacted person did not wish to proceed. This figure includes cases opened in FY2024 and prior to FY2024 that were closed during the reporting period. When referring to cases closed during FY2024, it excludes cases that were still open at the end of the reporting period.
3. As the established rate reflects the number of cases established out of all business conduct concerns closed during the reporting period, the parameter has been updated to better reflect the cases that are considered business conduct concerns at closure (i.e. the investigation category). Additionally, calculating the established rate based on investigation category provides a more stable measure since case attributes can vary whilst the investigation is underway and unlikely to change once the investigation has concluded and case is closed.
4. FY2024 data includes all former OZ Minerals assets in Australia and Brazil.

Employees and contractors can raise their concerns through a number of channels (including anonymously) or through leaders. Anyone, including external partners, stakeholders and the public, can lodge a concern in the form of a report, either online in our channels to raise misconduct concerns or via the 24-hour, multilingual call service.

### Anti-corruption

We continue our commitment to contribute to the global fight against corruption in the resources industry. Our commitment to anti-corruption is embodied in *Our Charter* and *Our Code*.

As part of this commitment, we prohibit authorising, offering, giving or promising anything of value directly or indirectly to anyone to influence them in their role, or to encourage them to perform their work disloyally or otherwise improperly. We also prohibit facilitation payments, which are payments to government officials for routine government actions. Our people must take care that third parties acting on our behalf do not violate anti-corruption laws. Disciplinary action, including dismissal or termination of contractual relationships, may follow from a breach of these requirements.

To manage corruption risk, we work to achieve optimal resource allocation to areas of our business with the highest exposure to corruption risks. The identification, assessment and management of corruption risks associated with growth opportunities remains a significant area of focus for our Compliance function, via a sub-team dedicated to supporting functions that are responsible for initiating transactions and growth opportunities in countries with higher corruption risks.

Activities that potentially involve higher exposure to corruption risk require review or approval by our Compliance function, as documented in our anti-corruption compliance framework. In FY2024, we continued conducting monitoring focused on verifying the operation of anti-corruption controls in relation to higher risk relationships and activities, including the provision of community donations and sponsorships, identification and management of corruption risks relating to government officials and community leaders in the context of local procurement, and sole source procurement decisions.

We regularly review our anti-corruption framework for compliance with the requirements of the US Foreign Corrupt Practices Act, the UK Bribery Act, the Australian Criminal Code and the applicable laws and regulatory developments of all places where we do business. These laws are consistent with the standards of the OECD Convention on Combating Bribery of Foreign Public Officials in International Business Transactions.

Our Compliance function is independent of our assets and regions and reports to the Chief Legal, Governance and External Affairs Officer. Our Chief Compliance Officer also reports quarterly to the Risk and Audit Committee on compliance issues and meets at least annually with the Risk and Audit Committee Chair.

The Compliance function also participates in anti-corruption risk assessments in respect of our operated assets or functions, our interests in non-operated assets and new business opportunities that we consider are exposed to material anti-corruption risks. In FY2024, the function provided input into 27 anti-corruption risk assessments.

Building employee awareness remains critical to the effective management of corruption risk across BHP. Anti-corruption training is required to be provided to all employees and contractors as part of mandatory regular training on *Our Code*. Our Compliance function also regularly communicates and engages with identified higher-risk roles and provides additional risk-based anti-corruption training for employees, contractors and employees of some of our business partners and community partners. In FY2024, we revised our anti-corruption electronic learning module to incorporate new scenarios designed to reinforce understanding and support learning. The new e-learning module is expected to be made available in early FY2025.

**>For more information on ethics and business conduct refer to [bhp.com/ethics](https://bhp.com/ethics)**

#### **Transparency and accountability**

We support initiatives by governments of the countries where we operate to publicly disclose the content of our licences or contracts for the development and production of minerals that form the basis of our payments to government, as outlined in the Extractive Industries Transparency Initiative (EITI) Standard.

Other initiatives include our work with Transparency International chapters, representation on the Board of the EITI, financial support for and Steering Committee membership of the Bribery Prevention Network (in Australia) and funding of the BHP Foundation, including its Natural Resource Governance Global Program.

We believe knowing who ultimately controls and benefits from a company helps to reduce risk and strengthen accountability. In FY2024, we continued our active and public support for ultimate beneficial ownership transparency. We maintained information on how we use beneficial ownership information as part of our anti-corruption due diligence on investments, partners, contractors and suppliers. We also continued to make clear via published statements, including in *Our Code* and web content, that we do not partner or contract with entities that are assessed as presenting a high corruption risk that decline to provide beneficial ownership information as part of our due diligence process. In parallel with these steps, we continued to publish our list of entities in which BHP Group Limited's effective interest is 100 per cent and certain entities in which BHP Group Limited's effective interest is less than 100 per cent, including all controlled subsidiaries operating in the mining sectors, all mining operations joint ventures generating material revenue for BHP (and available information in relation to the other legal owners in these joint ventures) and entities in which we hold a partial interest (with some exclusions – refer to [bhp.com/sustainability/ethics-business-conduct](https://bhp.com/sustainability/ethics-business-conduct)).

These efforts are complementary to the BHP Foundation's partnership with EITI and Open Ownership to support governments to transform the availability and use of beneficial ownership data for effective governance in the extractive sector.

### **6.9 Climate change**

We believe the warming of the climate is unequivocal, human influence is clear and physical climate-related impacts are unavoidable. We recognise the role we play in supporting the net zero transition the world must make.

**>For our full position on climate change refer to [bhp.com/climate](https://bhp.com/climate)**

#### **Climate-related governance**

Climate change and climate transition planning is a material governance and strategic issue for our Board and management. Additional details concerning our climate-related governance for FY2024 have been made in our Climate Transition Action Plan (CTAP 2024).

Our CTAP 2024 was approved by the Board, with its development and ongoing implementation governed by the Board and its Committees and management.

**>Our Board, Committees and management structure and roles as they apply to climate-related matters, the skills and experience of the Board and management and remuneration incentives for management are disclosed in *Enabling delivery – Our governance* on page 50 and *Enabling delivery – Our management, remuneration and organisational capability* on page 51 of our CTAP 2024 available at [bhp.com/CTAP2024](https://bhp.com/CTAP2024)**

**>For information on the role and composition of the Board and its Committees and each Committee's key activities in FY2024, including in relation to climate-related matters, as well as the Board skills matrix, the process for Board evaluation and director training, induction and development, refer to our *Corporate Governance Statement 3, 4 and 5* on pages 122-135, later in this Report**

#### **Our disclosures and approach to reporting**

##### **Climate Transition Action Plan**

In August 2024, we published our second Climate Transition Action Plan, which sets out our strategic approach and plans for achieving our operational and value chain greenhouse gas (GHG) emissions targets and goals, as well as our response to climate-related risks (threats and opportunities). This follows on from our first CTAP, which we published in CY2021.

Our CTAP 2024 is primarily a forward-looking plan and set of actions, while this Report discloses in:

- This OFR 6.9: Progress in FY2024 against our climate change strategy, GHG emissions targets and goals, commitments and key metrics
- Governance: An overview of governance structures, activities and remuneration incentives, including those that relate to our climate change strategy (additional detail concerning our governance around climate-related risks is set out in in our CTAP 2024)
- Financial Statements: Potential financial statement impacts, where material or relevant, of the assumptions, plans and actions of our climate change strategy and the consideration of climate-related risks in the assessment of significant areas of judgement and estimation required for the presentation of the financial statements

>[Our CTAP 2024 is available at bhp.com/CTAP2024](https://www.bhp.com/CTAP2024)

Given the global nature of our business, customers and supply chain, the development of our CTAP 2024 considered the goals of the Paris Agreement and the commitments and policy settings of relevant key jurisdictions at this time. Our global headquarters are located in Australia, which has a Long-Term Emissions Reduction Plan and legislated national targets to reduce Australia's net GHG emissions to 43 per cent below CY2005 levels by CY2030, and to achieve net zero GHG emissions by CY2050.

We continue to monitor and take into consideration the evolving policy and regulatory landscape applicable to our operations as part of the periodic review by management and the Board of the appropriateness of and our progress towards our GHG emissions targets and goals.

## Navigating our disclosures

TCFD recommended disclosures	Our response			
	This Report: Operating and Financial Review	This Report: Governance	This Report: Financial Statements	Climate Transition Action Plan 2024
<b>Governance: Disclose the organisation's governance around climate-related risks and opportunities.</b>				
a) Describe the board's oversight of climate-related risks and opportunities	Page 55	Pages 121 to 142	–	Page 50
b) Describe management's role in assessing and managing climate-related risks and opportunities	–	Pages 135 to 142	–	Page 51
<b>Strategy: Disclose the actual and potential impacts of climate-related risks and opportunities on the organisation's businesses, strategy, and financial planning where such information is material.</b>				
a) Describe the climate-related risks and opportunities the organisation has identified over the short, medium, and long term	Pages 59 to 62 Pages 87 to 98	–	Pages F-42 to F-46	Pages 10 to 30 Page 52
b) Describe the impact of climate-related risks and opportunities on the organisation's businesses, strategy, and financial planning	Pages 55 to 69 Pages 87 to 98	–	Pages F-42 to F-46	Pages 10 to 54
c) Describe the resilience of the organisation's strategy, taking into consideration different climate-related scenarios, including a 2°C or lower scenario	Pages 60 to 62	–	Pages F-42 to F-46	Pages 31 to 38 Pages 42 to 45 Pages 61 and 62
<b>Risk Management: Disclose how the organisation identifies, assesses, and manages climate-related risks.</b>				
a) Describe the organisation's processes for identifying and assessing climate-related risks	Pages 58 and 59 Pages 85 to 87	–	–	Page 52
b) Describe the organisation's processes for managing climate-related risks	Pages 59 to 62 Pages 85 to 87	–	–	Page 52
c) Describe how processes for identifying, assessing, and managing climate-related risks are integrated into the organisation's overall risk management	Pages 85 to 87	–	–	Page 52
<b>Metrics and Targets: Disclose the metrics and targets used to assess and manage relevant climate-related risks and opportunities where such information is material.</b>				
a) Disclose the metrics used by the organisation to assess climate-related risks and opportunities in line with its strategy and risk management process	–	Pages 148 to 162	–	Page 51
b) Disclose Scope 1, Scope 2, and, if appropriate, Scope 3 GHG emissions, and the related risks	–	–	–	Pages 10 to 30
c) Describe the targets used by the organisation to manage climate-related risks and opportunities and performance against targets	–	–	–	Pages 10 to 30 Pages 57 to 60

Operational GHG emissions (Scopes 1 and 2 emissions from our operated assets)	Value chain GHG emissions (Scope 3 emissions) – Overall
<p><b>Medium-term target:</b> Reduce operational GHG emissions (Scopes 1 and 2 emissions from our operated assets) by at least 30 per cent by FY2030 from an FY2020 baseline.</p> <p><b>Long-term net zero goal:</b> Achieve net zero operational GHG emissions (Scopes 1 and 2 emissions from our operated assets) by CY2050.</p>	<p><b>Long-term net zero goal:</b> We have a long-term goal of net zero Scope 3 GHG emissions by CY2050. Achievement of this goal is uncertain, particularly given the challenges of a net zero pathway for our customers in steelmaking, and we cannot ensure the outcome alone.</p>
<p><b>&gt;For more information on the essential definitions, assumptions, GHG emissions boundaries, measurement approach and adjustments for this medium-term target and these long-term net zero goals, including the potential use of offsetting, refer to Climate-related metrics, targets and goals on pages 52 to 59, in the BHP Annual Report 2024</b></p>	

**TCFD-consistent disclosures**

In accordance with the UK Listing Rules as set by the UK Financial Conduct Authority, we believe our disclosures are consistent with the four recommendations and 11 recommended disclosures of the Task Force on Climate-related Financial Disclosures (TCFD).

The ‘Navigating our disclosures’ table on the previous page sets out the TCFD’s recommended disclosures, grouped under the four recommendations and where our aligned disclosures can be found within this Report and our CTAP 2024.

Because our CTAP 2024 is our primary publication this year for disclosing significant detail on our climate change plan for the climate transition and our climate change strategy, we have included certain TCFD-recommended disclosures in our CTAP 2024 to enable them to be read in that broader context. We do not repeat them in this Report to avoid duplication. TCFD recommended disclosures for FY2024 that have been published in our CTAP 2024 are:

- TCFD Strategy recommended disclosures (a) and (b): Our detailed strategy and areas of focus for reducing operational GHG emissions (Scopes 1 and 2 emissions from our operated assets), including our industry collaboration and our material sources of operational GHG emissions (i.e. electricity, diesel and fugitive methane emissions).

**>These disclosures have been published in Operational GHG emissions on pages 10 to 18 in our CTAP 2024 available at [bhp.com/CTAP2024](https://www.bhp.com/CTAP2024)**

- TCFD Strategy recommended disclosures (a) and (b): Our detailed strategy for supporting the reduction of value chain GHG emissions (Scope 3 emissions).

**>These disclosures have been published in Value chain GHG emissions on pages 19 to 30 in our CTAP 2024 available at [bhp.com/CTAP2024](https://www.bhp.com/CTAP2024)**

- TCFD Strategy recommended disclosure (b) and (c): Detailed information on our strategy for our commodity and asset portfolio, as well as the resilience of our strategy and portfolio in our 1.5°C scenario

**>These disclosures have been published in Portfolio on pages 31 to 38, Additional information – Our 1.5°C scenario assumptions and the signposts we monitor on page 61 and Additional information – Our 1.5°C scenario compared to benchmarks on page 62 in our CTAP 2024 available at [bhp.com/CTAP2024](https://www.bhp.com/CTAP2024)**

- TCFD Governance recommended disclosures (a) and (b): Detailed information on our Board, Committees and management structure and roles as they apply to climate-related matters, the skills and experience of Board and management.

- TCFD Metrics and Targets recommended disclosure (a): The climate-related remuneration incentives for management, separate to the Remuneration Report in this Report.

**>These disclosures have been published in Enabling delivery – Our governance on page 50 and Enabling delivery – Our management, remuneration and organisational capability on page 51 in our CTAP 2024 available at [bhp.com/CTAP2024](https://www.bhp.com/CTAP2024)**

**>For more information on our alignment with other sustainability and ESG standards, including the Climate Action 100+ Net Zero Company Benchmark and GHG Protocol series of standards, refer to our BHP ESG Standards and Databook 2024 available at [bhp.com/climate](https://www.bhp.com/climate)**

**Capital allocation**

Capital allocation towards operational GHG emissions reduction initiatives is considered as part of the maintenance capital category within our Capital Allocation Framework. For FY2024, our capital (incremental) and operating expenditure on initiatives associated with operational GHG emission reductions was US\$61 million.

**>For more information on actual and planned expenditure to support operational GHG emission reductions refer to Financial Statements note 16 ‘Climate change’ on pages F-42 to F-46 in this Report**

Value chain GHG emissions (Scope 3 emissions) – Steelmaking	Value chain GHG emissions (Scope 3 emissions) – Direct suppliers
<b>Medium-term goal:</b> Support industry to develop steel production technology capable of 30 per cent lower GHG emissions intensity relative to conventional blast furnace steelmaking, with widespread adoption expected post-CY2030.	<b>Long-term net zero target:</b> Achieve net zero by CY2050 for the operational GHG emissions (Scopes 1 and 2 emissions) of our direct suppliers.
<p>We have revised the language used in our medium-term goal for steelmaking to provide greater clarity and to reflect the range of steelmaking process routes that now form part of our strategy. This is due to technology advances as well as the evolution of our strategy.</p> <p><b>&gt;For more information on how and why we revised the language used in our medium-term goal, refer to Value chain GHG emissions – Steelmaking: Our Scope 3 emissions goal to support capability for GHG emissions intensity reduction on pages 24 and 25 of our CTAP 2024 available at <a href="https://bhp.com/CTAP2024">bhp.com/CTAP2024</a></b></p> <p><b>&gt;For more information on the essential definitions, assumptions, GHG emissions boundaries, measurement approach and adjustments for these medium-term goals, including the potential use of offsetting, refer to Climate-related metrics, targets and goals on pages 52 to 59, in the BHP Annual Report 2024</b></p>	

Value chain GHG emissions (Scope 3 emissions) – Shipping	Value chain GHG emissions (Scope 3 emissions) – Shipping
<b>Medium-term goal:</b> Support 40 per cent GHG emissions intensity reduction of BHP-chartered shipping of BHP products by CY2030, from a CY2008 baseline.	<b>Long-term net zero target:</b> Achieve net zero by CY2050 for the GHG emissions from all shipping of BHP products.
<p><b>&gt;For more information on the essential definitions, assumptions, GHG emissions boundaries, measurement approach and adjustments for this medium-term goal and this long-term net zero target, including the potential use of offsetting, refer to Climate-related metrics, targets and goals on pages 52 to 59, in the BHP Annual Report 2024</b></p>	

## Climate-related risk management

### How we identify and manage climate-related risk

At BHP, we take an enterprise approach to risk management and operate under one Risk Framework for all risks, including climate-related risks (threats and opportunities). Our Risk Framework requires the identification and management of risks to be embedded in business activities and provides requirements and guidance on the tools and processes to manage current and emerging risks. Our mandatory minimum performance requirements for risk management and the *Climate Change Global Standard* set the minimum requirements to manage climate-related risks and apply across our operated assets and functions, and to decision-making processes for sales, marketing and procurement.

To support the identification and management of climate-related risks at BHP, we monitor and interpret external signals, events and trends associated with transition risk and physical climate-related risk, which may include existing and emerging scientific, policy, legal and regulatory, reputational, and market developments.

Risk owners of climate-related risks must assess physical and transition climate-related risks, considering potential impacts, including to safety, productivity and cost across operated assets, value chains, infrastructure and services, and host communities.

The *Climate Change Global Standard* also sets mandatory minimum requirements for assessing physical climate-related risks (refer to Physical climate-related risks and adaptation in this OFR 6.9, for our progress to date), as well as for asset-level climate change plans and the value chain climate adaptation plan owned by our Commercial function. A number of these assessments and plans are still underway, and they are also regularly reviewed and revised to ensure continued relevance.

When assessing the materiality of climate-related risks (as for all risks identified through our Risk Framework), we consider the likelihood (by reference to timeframes) and severity of potential impacts (including to health and safety, the environment, communities, human rights and social value) by estimating the maximum foreseeable loss (MFL) if that risk were to materialise. The MFL is the estimated impact to BHP in a worst-case scenario without regard to probability and assuming all controls are ineffective. This supports us to prioritise and understand the significance of climate-related risks in relation to other risks.

**>For more information on how we manage risk (including climate-related risk) and our risk factors refer to OFR 8 on pages 87 to 98 in this Report**

We recognise a changing climate can influence or exacerbate risks across our risk profile, including those associated with asset integrity, pricing of inputs, access to markets, changes to regulation and access to funding. Decisions on the prioritisation of actions to manage climate-related threats or pursue climate-related opportunities are made consistent with our standard risk management, planning and investment processes applicable to all risks identified under our Risk Framework. Using a consistent approach allows us to consider climate-related risks across our business to focus our actions on those that are material and integrate management of them into our core activities and business plans. We continue to embed climate-related risk across our risk profile and to improve the controls required to manage threats or enhance opportunities. We also continue to review our climate-related risk profile periodically, seeking to identify, assess and manage new or evolving climate-related risks.

## Climate-related risks

In setting and monitoring the delivery of our strategy, we consider identified climate-related risks (threats and opportunities), both physical and transition (as applicable and to the extent their potential impacts are sufficiently understood) across the following time horizons:

- short-term (zero to two years), aligning with our two-year budget process
- medium-term (two to five years), defining supportive actions and initiatives that sit outside of our two-year budget process in order to support our long-term strategy
- long-term (five to 30 years, or longer in certain cases), given our supply, demand and pricing forecasts and our scenarios for portfolio analysis extend to CY2050 and in some cases beyond

Climate-related risks are broadly categorised as:

- Transition risks, which arise from existing and emerging policy, regulatory, legal, technological, market and other societal responses to the challenges posed by climate change and the transition to a net zero economy

**>For detailed disclosures on the management of transition risks refer to Transition to a net zero economy on page 60 in this OFR 6.9, and in Portfolio on pages 31 to 38 in our CTAP available at [bhp.com/CTAP2024](http://bhp.com/CTAP2024)**

- Physical risks, which refer to acute risks that are event-driven (including increased severity and frequency of extreme weather events) and chronic risks resulting from longer-term changes in climate patterns

**>For detailed disclosures about the studies we are undertaking to assess our exposure to physical climate-related risks refer to Physical climate-related risks and adaptation on page 61 in this OFR 6.9**

Relevant BHP Group risk factors (refer to OFR 8 for more information)	Climate-related risk	Potential influence of climate-related issues on BHP Group risk factors over time <sup>1</sup>		
		Short-term (0 to 2 years)	Medium-term (2 to 5 years)	Long-term (5 to at least 30 years)
<b>Transition risk</b>				
Operational events	<ul style="list-style-type: none"> <li>• Technological solutions to reduce GHG emissions</li> </ul>	Low	Low to medium	High
Significant social or environmental impacts	<ul style="list-style-type: none"> <li>• Engaging in or association with activities with actual or perceived adverse climate-related impacts</li> <li>• Failure to meet evolving stakeholder expectations</li> <li>• Political, regulatory or judicial developments</li> </ul>	Low	Low to medium	High
Low-carbon transition	<ul style="list-style-type: none"> <li>• Low to zero GHG emission technologies or changes in customer preferences altering demand for our products</li> <li>• Perceptions of climate-related financial risk reducing access to capital and/or insurance for BHP or our customers or suppliers</li> <li>• Reputational damage and litigation</li> <li>• Adverse market, legal or regulatory responses</li> </ul>	Low	Low	High
Adopting technologies and maintaining digital security	<ul style="list-style-type: none"> <li>• Technological solutions to reduce GHG emissions</li> </ul>	Low	Low	High
Optimising growth and portfolio returns	<ul style="list-style-type: none"> <li>• Failure to achieve expected commercial objectives due to climate-related impacts</li> </ul>	Low	Low	High
Accessing key markets	<ul style="list-style-type: none"> <li>• Legal or regulatory changes, with respect to carbon-intensive industries and exports</li> </ul>	Low	Low	High
Inadequate business resilience	<ul style="list-style-type: none"> <li>• Geopolitical, global economic, regional or local developments or adverse events</li> </ul>	Low	Low	High
<b>Physical risk</b>				
Operational events	<ul style="list-style-type: none"> <li>• Extreme weather and other climate-related events that may impact production</li> </ul>	Low	Low	Medium
Significant social or environmental impacts	<ul style="list-style-type: none"> <li>• Failure to adequately identify or to appropriately manage physical climate-related risks</li> </ul>	Low	Low to medium	Medium
Inadequate business resilience	<ul style="list-style-type: none"> <li>• Acute and chronic physical climate-related impacts, event-driven and longer-term changes in climate patterns</li> </ul>	Low	Low	Medium

Climate change and climate-related risks have the potential to influence or exacerbate risks across our operations and functions and are required to be considered and, where applicable, integrated in accordance with our Risk Framework into our asset risk profiles to be managed across each of these time horizons (see the table above). The linkage of these time horizons to our planning processes and activities and strategy formation informs our decision-making and enables us to take appropriate and timely risk management actions.

### Footnote

<sup>1</sup> The estimated potential (i) change to the level of influence of relevant climate-related issues and their associated risk factors on BHP's existing risk exposure and/or (ii) degree to which they may exacerbate existing risks within our risk profile, based on currently available information and noting that some assessments are preliminary and/or incomplete (particularly in relation to physical climate-related risk) and may change significantly.



**>For more information on BHP's Risk Framework, how we manage climate-related risks and the potential impact to BHP operations refer to OFR 8 on pages 87 to 98 in this Report**

## **Transition to a net zero economy**

### **Our portfolio's resilience**

We continue to seek to maximise our exposure to products that enable and support decarbonisation and electrification, urbanisation and a growing population, and to minimise the risk that capital may be stranded in a rapidly decarbonising world. To support this outcome, we consider a range of inputs, including our 1.5°C scenario, when testing the resilience of our portfolio and making investment decisions.

Our CTAP 2024 analyses our portfolio's resilience in our new 1.5°C scenario and describes key input assumptions, analytical methods, outputs and sensitivities we used in or derived from this scenario.

We use our planning range (our long-term forecast of demand, supply and price across our commodities) for operational planning. It is comprised of three unique, independent planning cases: a 'most likely' base case, and an upside case and downside case that provide the range's boundaries. These three cases reflect proprietary forecasts for the global economy and associated sub-sectors (i.e. energy, transport, agriculture, steel) and the resulting market outlook for our core commodities. The assessments of future states are not explicitly climate scenarios designed to test the resilience of our portfolio to different global climate action trajectories. However, in all three future state estimates, while the global gross domestic product assumptions and pace and drivers of decarbonisation policy and technology diffusion vary, most developed economies reach net zero around CY2050, with other developing economies reaching net zero in CY2060 and CY2070. The modelled output of our planning range results in global CO<sub>2</sub> emission pathways implying a projected global temperature increase of around 2°C by CY2100.

Our planning range's demand, supply and price forecasts for key commodities are used to inform data inputs into our operational modelling and drive operational planning. Our planning range is also used for strategy formation and investment decisions.

We use our 1.5°C scenario to derive commodity price sensitivities to assess potential impacts on portfolio value compared with our base case valuations using our planning range. Our modelling indicates our portfolio remains resilient under our 1.5°C scenario. The value of our copper, potash and nickel assets increases relative to the base case of our planning range, and offsets the effect to our portfolio from some downside risk to steelmaking coal. The net present value of our portfolio under our 1.5°C scenario is approximately the same as under the current base case of our planning range, indicating we would be resilient in an accelerated transition to a 1.5°C outcome. Western Australia Nickel's temporary suspension (see below) has not altered our scenario analysis, which includes nickel in our portfolio.

As described elsewhere in this Report, as well as in our CTAP 2024, we continue to reposition our portfolio towards commodities that can enable and support megatrends, such as global decarbonisation and electrification. Our actions to enable and support include BMA's divestment of the Blackwater and Daunia mines as a further step to concentrate our coal portfolio on the higher-quality (grade) coals increasingly preferred by steelmaking customers and the acquisition of OZ Minerals in FY2023 to support the creation of a South Australia copper basin. We expect such actions to further enhance the overall resilience of our portfolio over time.

In July 2024, we announced our Nickel West operations and West Musgrave project (Western Australia Nickel) would be temporarily suspended from October 2024. Over the longer term, our 1.5°C scenario and the base case of our planning range see nickel demand growing in response to the transition. However, the decision to temporarily suspend operations follows oversupply in the global nickel market. At the time of our announcement, forward consensus nickel prices over the next half of the decade had fallen sharply reflecting strong growth of alternative low-cost nickel supply.

**>For more analysis of our portfolio's resilience in our new 1.5°C scenario and more information about the three planning cases in our planning range and their use refer to Portfolio on pages 31 to 38 of our CTAP 2024, available at [bhp.com/CTAP2024](https://bhp.com/CTAP2024)**

**>For key assumptions and metrics for our new 1.5°C scenario and a comparison with other 1.5°C scenarios refer to Additional information – Our 1.5°C scenario assumptions and the signposts we monitor on page 61 and Additional information – Our 1.5°C scenario compared to benchmarks on page 62 of our CTAP 2024 available at [bhp.com/CTAP2024](https://bhp.com/CTAP2024)**

**>For disclosures related to potential financial statement impacts in our new 1.5°C scenario refer to Financial Statements note 16 'Climate change' on pages F-42 to F-46 in this Report**

### **Impact on our business, strategy and capital alignment and allocation**

The final (or sufficiently resolved) results of our climate-related risk assessments across our short-, medium- and long-term time horizons (as described on page 58 to 59), as well as our 1.5°C scenario, are considered and integrated into our strategy and as a sensitivity in our capital allocation processes. This enables us to test the extent to which our business and capital allocation are aligned with a rapidly decarbonising global economy.

We are undertaking our studies of physical climate-related risks to progressively identify, assess and quantify the potential future impacts to site operations, productivity and estimated cost for our operated assets. Once the results of the risk quantification studies for our operated assets are completed, we propose to use the results to inform updates to our risk profile, including new risk management activities, inform corporate planning, identify areas where we should focus our assessment of new or strengthened controls or adaptation responses, and assess the financial and social value of adaptation measures.

**>For an overview of how climate-related issues have impacted our operational activities and our approach with respect to our value chain refer to Operational GHG emissions (Scopes 1 and 2 emissions from our operated assets) on pages 57 and Value chain GHG emissions (Scope 3 emissions) on pages 58 in this OFR 6.9**

**>For more information on potential financial statement impacts due to climate-related risks, refer to Financial Statements note 16 'Climate change' on pages F-42 to F-46 in this Report**

**> For more information on the studies we are undertaking to assess our exposure to physical climate-related risks refer to Physical climate-related risk and adaptation on page 51 in the BHP Annual Report 2024**

**>For more information on our commodity production, revenue and expenditure refer to Climate-related metrics, targets and goals on pages 52 to 59 in the BHP Annual Report 2024**

### **Carbon pricing**

We embed carbon prices within our planning range and planning cases that inform asset planning, asset valuations and operational decision-making, including the prioritisation of operational GHG emission reduction projects.

**>For our qualitative and quantitative disclosures related to carbon pricing refer to Financial Statements note 16 'Climate change' on pages F-42 to F-46 in this Report**

### **Equitable change and transition**

We seek meaningful, long-term, mutually beneficial relationships that respect local cultures. We aim to support the development of diversified and resilient local communities and economies that contribute to wellbeing that continues beyond the life of our operated assets.

**>For information on the work we are undertaking to leave a positive legacy from our mining in the Hunter Valley as we move towards the planned closure of Mt Arthur Coal refer to Equitable change and transition on pages 46 to 48 of our CTAP 2024 available at [bhp.com/CTAP2024](http://bhp.com/CTAP2024)**

### **Climate policy advocacy**

We believe governments around the world should adopt and progress policies aligned with the goals of the Paris Agreement to limit the increase in the global average temperature by CY2100 to well below 2°C above pre-industrial levels and pursue efforts to limit the increase to 1.5°C. We commit to conducting our climate policy advocacy consistent with these goals in our direct advocacy and our indirect advocacy. Our Climate Policy Principles show how we intend this commitment to be translated into action.

**>Our Climate Policy Principles, the approach we take to our direct and indirect advocacy, and our latest advocacy disclosures are available at [bhp.com/sustainability/climate-change/advocacy-on-climate-policy](http://bhp.com/sustainability/climate-change/advocacy-on-climate-policy) and [bhp.com/about/operating-ethically/industry-associations](http://bhp.com/about/operating-ethically/industry-associations)**

**>For more information on our policy advocacy refer to Climate policy advocacy on pages 39 to 41 of our CTAP 2024 available at [bhp.com/CTAP2024](http://bhp.com/CTAP2024)**

### **Physical climate-related risks and adaptation**

A changing climate can exacerbate and create physical climate-related risks, which include:

- Acute physical climate-related risks: Extreme climatic events, such as floods, cyclones and heatwaves, that may be more severe or more frequent because of a changing climate
- Chronic physical climate-related risks: The incremental worsening of conditions, such as the gradual increase in the number of extreme heat days over the years, or rising sea levels

The mining sector is exposed to both acute and chronic physical climate-related risks because of its remote outdoor operations with labour and physical capital exposed to the elements, and because of its dependency on global value chains. The long lives of mining assets mean they could encounter deteriorating conditions in later decades. Geographically dispersed sites and value chains increase the diversity of physical climate-related impacts we could encounter.

We are undertaking studies to assess our exposure to physical climate-related risks that draw on science-based climate data. We are working to complete these studies and continue verification and review of results in FY2025. Our approach to evaluating our operational physical climate-related risks is illustrated in the 'Our approach to physical climate-related risk' diagram.

## Our approach to physical climate-related risk



### Climate modelling

We commissioned WTW (one of our insurance advisors) to develop a climate dataset covering our operated assets and some key value chain locations, to develop a more holistic understanding of the potential parameters of our physical climate-related risk exposure and how it may change over time.

This climate dataset is based on the publicly available Shared Socioeconomic Pathways (SSP) scenarios used by the Intergovernmental Panel on Climate Change, and includes latest generation (Coupled Model Intercomparison Project Phase 6 (CMIP6)) and CMIP5 climate models, applied to our operated assets. The dataset covers more than 20 climate-related hazards potentially relevant to our global operations, such as average temperature, extreme precipitation, and cyclones, which can represent physical climate-related risks. Alongside this we apply local observational climate data and other sources of climate projections. This approach allows us to develop a localised view of potential impacts, including changes in rainfall patterns, average and maximum temperatures and sea level rise.

The climate dataset includes a baseline (CY2001 to CY2020) and projections for three future time horizons (CY2026 to CY2045, CY2046 to CY2065, CY2066 to CY2085) for the following Intergovernmental Panel on Climate Change SSP-based GHG emission scenarios:<sup>1</sup>

- Low-case: Estimated average global temperature increase of 1.8°C by CY2100 (SSP1-2.6)
- Mid-case: Estimated average global temperature increase of 2.7°C by CY2100 (SSP2-4.5)
- High-case: Estimated average global temperature increase of 4.4°C by CY2100 (SSP5-8.5)

The table ‘Potential physical climate-related risks at our operated assets and in their value chains’ on this page shows the physical climate-related risks that our studies to date indicate could have potential impact for our operated assets (including via impacts in our value chain). The first stage of our analysis looks at our operated assets that are currently producing (excluding NSWEC and former OZ Minerals sites) and our Jansen potash project. We plan to include currently producing former OZ Minerals sites and to expand and adapt our approach to incorporate our legacy assets and NSWEC in FY2025.

### Footnote

1. Table SPM.1, Summary for Policymakers. In: Climate Change 2021: The Physical Science Basis. Contribution of Working Group I to the Sixth Assessment Report of the Intergovernmental Panel on Climate Change. IPCC, CY2021

### Potential physical climate-related risks at our operated assets and in their value chains

Climate hazard	Potential operational site impacts
<b>Extreme precipitation and/or flooding</b>	Inundation of mines and/or key production infrastructure Disruption and/or damage to water supply infrastructure Exacerbation of tailings storage facility failure risk
<b>Coastal hazards</b> (including higher sea levels, cyclones, storm surge and changes in marine ecosystems)	Disruption and/or damage to port and coastal infrastructure and operations
<b>Extreme temperatures</b>	Disruption and/or damage to electrical infrastructure
<b>Changes in rainfall, temperature and/or evaporation patterns</b>	Water shortages for operational activities Workforce health and safety incidents
<b>Extreme weather events</b> (including extreme heat, extreme precipitation and/or flooding, cyclones)	Disruption in the supply of critical production inputs, and access to supply chain infrastructure

**>For more information on our approach to physical climate-related risk quantification studies, existing risk controls and potential adaptation responses refer to Physical risk and adaptation on pages 42 to 45 of our CTAP 2024 available at [bhp.com/CTAP2024](https://www.bhp.com/CTAP2024)**

**>For more information on how physical climate-related risk has been considered in asset carrying values refer to Financial Statements note 16 'Climate change' on pages F-42 to F-46 in this Report**

### The role of our commodities in the transition

We continue to engage with investors, industry and standard setters to explore ways of establishing clear methodologies for classification and measurement of 'green revenue'<sup>1</sup> and associated capital expenditure within the resources sector. We note that, at present, there are still divergent and evolving views globally on what constitutes green revenue, with no clear definition or expectations for other sustainability indicators for the resources sector.

Traceability of end use for many commodities, such as copper and nickel, remains a challenge as they undergo multiple stages of processing and have a diverse range of end uses. Given this continued uncertainty, we have presented multiple classifications of certain of our commodities to reflect a view on their actual or potential contribution to the transition to a net zero economy.

The classification we have given to our commodities (described in the table below) is intended to be an indicative approach pending clear and resolved methodologies for identifying key transition materials that contribute to the transition to a net zero economy and the calculation of the revenues they generate. We also acknowledge the classification focuses on the theme of enabling the transition to a net zero economy to mitigate climate change, and broader sustainability indicators in relation to how these commodities are produced are also important to consider.

Classification	Definition	Commodities
Climate Action 100+ Net Zero Standard for Diversified Mining, September 2023	Key transition materials	Copper, nickel
FTSE Russell's Green Revenues Classification System, v1.1, January 2024	Key raw minerals and metals	Uranium
BHP	Future-facing commodities <sup>2</sup>	Copper, nickel, potash

We believe steelmaking materials like iron ore and steelmaking coal also have an important role to play in the global transition to net zero. We expect the blast furnace with carbon capture, utilisation and storage (CCUS) to be an important part of the journey towards the end-state objective of widespread near zero emission steel, and it requires higher-quality steelmaking coal as an input. External analysis, such as the International Energy Agency's net zero by 2050 scenario,<sup>3</sup> supports this view.

**>Our view on steelmaking materials and their role in the transition to net zero is described in Portfolio - Steelmaking, iron ore and steelmaking coal in our 1.5°C scenario on pages 37 and 38 of our CTAP 2024 available at [bhp.com/CTAP2024](https://www.bhp.com/CTAP2024)**

### Footnotes

1. 'Green revenue' is a label referenced externally, including by standard setters and in investor-led benchmarks, which is intended as a measure of the extent to which products and services contribute to the transition to a net zero, resource efficient and socially inclusive economy. For more information refer to [unep.org/regions/asia-and-pacific/regional-initiatives/supporting-resource-efficiency/green-economy](https://www.unep.org/regions/asia-and-pacific/regional-initiatives/supporting-resource-efficiency/green-economy)
2. Commodities that we determine to be positively leveraged in the energy transition and broader global response to climate change, with potential for decades-long demand growth to support emerging mega-trends like electrification and decarbonisation.
3. International Energy Agency's World Energy Outlook 2023, [iea.org/reports/world-energy-outlook-2023](https://www.iea.org/reports/world-energy-outlook-2023)

**Operational GHG emissions (Scopes 1 and 2 emissions from our operated assets) medium-term target and long-term net zero goal definitions, assumptions, adjustments and additional key details**

	<b>Medium-term target</b>	<b>Long-term net zero goal</b>
<b>Description</b>	Reduce operational GHG emissions by at least 30 per cent from FY2020 levels by FY2030	Achieve net zero operational GHG emissions by CY2050
<b>Baseline year or reference year and period</b>	Baseline year: FY2020 Period: FY2020 to FY2030	Reference year: FY2020. FY2020 is used as a reference year to track progress towards our goal, but is not a baseline year for achieving our goal. Period: FY2020 to CY2050
<b>Type and reduction</b>	Type: Absolute Reduction: Gross; At least 30 per cent	Type: Absolute Reduction: Net; 100 per cent (where we currently estimate up to around an 85 per cent gross operational GHG emissions reduction against FY2020 levels by CY2050 without the use of carbon credits for offsetting)
<b>Boundary</b>	Inventory boundary: Scopes 1 and 2 emissions: Operational control	
<b>Exclusions</b>	Non-operated assets and equity investments (included in our value chain GHG emissions (Scope 3 emissions) long-term net zero goal)	
<b>GHGs included</b>	CO <sub>2</sub> , CH <sub>4</sub> , N <sub>2</sub> O, HFC, PFC, SF <sub>6</sub>	
<b>Offsetting</b>	Our plan is to achieve our medium-term target through structural GHG emissions abatement instead of offsetting our operational GHG emissions. We will not use regulatory carbon credits (i.e. those used for compliance under regulatory schemes such as Australia's Safeguard Mechanism) to meet our target. In our projected pathway, we have not planned to use voluntary carbon credits to meet our medium-term target, but if there is an unanticipated shortfall in our pathway, we may use voluntary carbon credits that meet our integrity standards to close the performance gap.	Planned, to close the performance gap beyond our current estimate of up to around an 85 per cent gross operational GHG emissions reduction against FY2020 levels by CY2050 without the use of carbon credits for offsetting.
<b>Measurement approach</b>	Scope 1 emissions are calculated using emission factors and methodologies required under mandatory local regulatory programs where BHP operates, including the National Greenhouse Energy and Reporting (NGER) scheme for Australian operations, Green Tax legislation (referencing Intergovernmental Panel on Climate Change (IPCC) emission factors) for Chilean operations and Canadian Greenhouse Gas Reporting Program (referencing IPCC emission factors) for our Jansen potash project. In the absence of mandatory local regulatory programs, the Australian NGER scheme emission factors and methodology is used. Scope 2 emissions are calculated using the market-based method using electricity emission factors sourced directly from the supplier where available, as evidenced by Renewable Energy Certificates and/or supplier-provided documentation. Where supplier-specific emission factors are not available, a default location-based emission factor for electricity, as published in local regulations or industry frameworks, is used.	

<b>Key adjustments made to baseline year or reference year and subsequent data</b>	Baseline year (for our target) and reference year (for our goal) and performance data have been adjusted for divestment of our interest in BMC (completed on 3 May 2022), divestment of our Petroleum business (merger with Woodside completed on 1 June 2022), BMA's divestment of the Blackwater and Daunia mines (completed on 2 April 2024), our acquisition of OZ Minerals (completed on 2 May 2023) and for methodology changes (use of IPCC Assessment Report 5 (AR5) Global Warming Potentials and the transition to a facility-specific GHG emission calculation methodology for fugitives at Caval Ridge and Saraji South).	
<b>Performance, adjusted</b>	FY2020: 13.6 MtCO <sub>2</sub> -e   FY2021: 13.8 MtCO <sub>2</sub> -e   FY2022: 10.2 MtCO <sub>2</sub> -e   FY2023: 9.1 MtCO <sub>2</sub> -e   FY2024: 9.2 MtCO <sub>2</sub> -e	
<b>Target or goal setting method</b>	Our target is measured on a cumulative GHG emission basis against an overall carbon budget. The target percentage reduction was established in FY2020 by applying the same rate of reduction to BHP's GHG emissions as the rate at which the world's GHG emissions would have to contract in order to meet the Paris Agreement goal to hold global average temperature increase to well below 2°C above pre-industrial levels (known as the 'absolute contraction method').	Our goal was developed with the ambition to achieve net zero for our operational GHG emissions by CY2050. Our progress against this goal will be measured on an absolute basis.
<b>Target or goal derived using a sectoral decarbonisation approach</b>	No, our target was derived using the absolute contraction method specified earlier. At the time of setting the target, there were no mining sector-specific pathways for jurisdictions where we operate.	No, however our goal is consistent with the global net zero ambition.
<b>Process for reviewing the setting of the target or goal</b>	The Board approves BHP's significant social, community and sustainability policies (upon recommendation from the Nomination and Governance Committee), including those related to climate change and climate transition planning, public sustainability goals and targets (including for GHG emission reductions). We review our GHG emissions targets and goals as part of the periodic development of an updated CTAP, or more frequently if required.	
<b>Process for monitoring progress towards the target or goal</b>	Monitored on an annual basis through our business planning processes, which forecast operational GHG emissions and identify planned, proposed or potential GHG emission reduction projects out to CY2050. As part of this process, an internal GHG emissions target is set for the relevant financial year and monitored through our annual reporting processes, with progress reviewed by management and the Board as part of publication of our annual reporting disclosures. Our target is also monitored on a six-monthly basis through our social value scorecard framework, with progress reviewed by management and the Board as part of publication of our half-year results (as well as annual reporting disclosures), or more frequently if required.	
<b>Third-party validation of our target or goal</b>	No, but we obtain reasonable assurance over our externally reported performance against our target and goal.	
<b>Carbon budget for target or goal period</b>	126.9 MtCO <sub>2</sub> -e (FY2020 to FY2030). This reflects a linear reduction between our baseline year and the target year. In the interim years before FY2030, we periodically refer to our carbon budget to assess our cumulative GHG emissions against our carbon budget to FY2030. This enables us to determine if we are on track to achieve our medium-term target or whether we anticipate potential use of voluntary carbon credits to close any performance gap by FY2030 (which we do not currently anticipate).	For the period FY2020 to FY2030, refer to the carbon budget for our target. We do not currently use a carbon budget for the period beyond FY2030.
<b>Expected progression</b>	Progress towards our target and goal is expected to be non-linear and will be affected by organic changes in our production of commodities.	

	<b>Steelmaking medium-term goal</b>	<b>Shipping medium-term goal</b>
<b>Description</b>	Support industry to develop steel production technology capable of 30 per cent lower GHG emissions intensity relative to conventional blast furnace steelmaking, with widespread adoption expected post-CY2030.	Support 40 per cent GHG emissions intensity reduction of BHP-chartered shipping of BHP products
<b>Baseline year or reference year, and period</b>	Reference year: CY2020 (global average GHG emissions intensity for conventional blast furnace steelmaking as at CY2020, being 2.2 tonnes of CO <sub>2</sub> per tonne of crude steel. Source: IEA Iron and Steel Technology Roadmap (October 2020)). CY2020 is used as a reference year to assess the potential of collaborative partnerships and venture capital investments to which we may commit funding (refer to 'measurement approach' later in this table), but is not a baseline year for achieving our goal. Period: FY2020 to CY2030.	Baseline year: CY2008 (reflecting International Maritime Organisation (IMO) objectives for the shipping industry) Period: CY2008 to CY2030
<b>Type and reduction</b>	Type: Not applicable Reduction: Not applicable	Type: Intensity Reduction: Gross; 40 per cent
<b>Boundary</b>	Not applicable	<ul style="list-style-type: none"> <li>– GHG emissions from maritime transportation not owned or operated by BHP, but chartered and paid for by BHP, where the transportation was of BHP-produced products sold by BHP. In some cases, the goal's boundary may differ from the boundaries under mandatory reporting.</li> <li>– Inventory boundary: Scope 3 emissions, Category 4, shipping of BHP products only.</li> </ul>
<b>Exclusions</b>	Not applicable	<ul style="list-style-type: none"> <li>– GHG emissions from maritime transportation owned, operated and/or chartered and paid for by a third party, where the transportation was of BHP-produced products sold by BHP.</li> <li>– GHG emissions from maritime transportation not owned or operated by BHP, but chartered and paid for by BHP, where the transportation was of third-party-produced products sold by BHP (pursuant to our third-party trading activity).</li> <li>– GHG emissions from maritime transportation not owned or operated by BHP, but chartered and paid for by BHP or a third party, where the transportation was of products purchased by BHP.</li> </ul>
<b>GHGs included</b>	Not applicable	CO <sub>2</sub> , CH <sub>4</sub> , N <sub>2</sub> O
<b>Offsetting</b>	Not applicable	Not planned but will be periodically assessed
<b>Measurement approach</b>	Committed funding (US\$) for collaborative partnerships and venture capital investments with the aim to support industry to develop steel production technology capable of 30 per cent lower GHG emissions intensity relative to conventional blast furnace steelmaking.	Average gCO <sub>2</sub> -e per deadweight tonne per nautical mile (gCO <sub>2</sub> -e/dwt/nm), weighted based on IMO defined vessel size ranges utilised by BHP during the time period, using a well-to-wake CO <sub>2</sub> -e emission factor from EU Regulation 2023/1805.
<b>Key adjustments made to baseline year and subsequent data</b>	Not applicable	Baseline year and performance data have been adjusted to only include voyages associated with the transportation of commodities currently in BHP's portfolio due to the data availability challenges of adjusting by asset or operation for CY2008 and subsequent year data. GHG emissions intensity calculations currently include the transportation of copper, iron ore, steelmaking coal, energy coal, molybdenum, uranium and nickel. Baseline year and performance data have also been adjusted for a methodology change to use maritime transport emission factors from EU Regulation 2023/1805, after The British Standards Institution EN 16258 standard (the source of the emission factors we previously used) was withdrawn in CY2023.

<b>Goal setting method</b>	Qualitative. Tracked based on the funding (US\$) we commit in collaborative partnerships and venture capital investments with the aim to support industry to develop steel production technology capable of 30 per cent lower GHG emissions intensity relative to conventional blast furnace steelmaking.	Set as a point in time, i.e. with the specific date of 'by CY2030' for our goal to support a 40 per cent GHG emissions intensity reduction of BHP-chartered shipping of BHP products, while reflecting the challenges and uncertainty and our inability (as BHP alone) to ensure Scope 3 emission reductions. As a result, the goal is not based on a trajectory and does not imply a specific carbon budget, and so Scope 3 emissions may fluctuate (with some increases and/or non-linear decreases) during the period before the goal date.
<b>Goal derived using a sectoral decarbonisation approach</b>	Not applicable	No, although our goal is generally consistent with the IMO's CY2030 emissions intensity goal for the international shipping sector and we selected CY2008 as our goal's baseline year to align with the base year for the IMO's CY2030 goal and its corresponding reasoning and strategy.
<b>Process for reviewing the setting of the goal</b>	The Board approves BHP's significant social, community and sustainability policies (upon recommendation from the Nomination and Governance Committee), including those related to climate change and climate transition planning, public sustainability goals and targets (including for GHG emission reductions). We review our GHG emissions targets and goals as part of the periodic development of an updated CTAP, or more frequently if required.	
<b>Process for monitoring progress towards the goal</b>	Monitored on a six-monthly basis through our social value scorecard framework, with progress reviewed by management and the Board as part of publication of our half-year results and annual reporting disclosures, or more frequently if required.	
<b>Third-party validation of our goal</b>	No, but we obtain limited assurance over our externally reported performance against our goals.	
<b>Carbon budget for goal period</b>	Not applicable	Our goal is not based on a trajectory and does not imply a specific carbon budget.
<b>Expected progression</b>	Not applicable	Progress towards our goal is expected to be non-linear and affected by organic changes in our production of commodities and associated increases in vessel chartering, due to the dependence on the availability of GHG emission reduction solutions more broadly across the shipping industry.



	Value chain long-term net zero goal	Shipping long-term net zero target	Direct suppliers long-term net zero target
<b>Description</b>	We have a long-term goal of net zero Scope 3 GHG emissions by CY2050. Achievement of this goal is uncertain, particularly given the challenges of a net zero pathway for our customers in steelmaking, and we cannot ensure the outcome alone	Target net zero by CY2050 for the GHG emissions from all shipping of BHP products. Ability to achieve the target is subject to the widespread availability of carbon neutral solutions to meet our requirements, including low to zero GHG emission technologies, fuels, goods and services	Target net zero by CY2050 for the operational GHG emissions of our direct suppliers. Ability to achieve the target is subject to the widespread availability of carbon neutral solutions to meet our requirements, including low to zero GHG emissions technologies, fuels, goods and services
<b>Reference year, and period</b>	Reference year: FY2020. FY2020 is used as a reference year to track progress towards our targets and goal, but is not a baseline year for achieving our targets or goal. Period: FY2020 to CY2050		
<b>Type and reduction</b>	Type: Absolute Reduction: Net; 100 per cent		
<b>Boundary</b>	<ul style="list-style-type: none"> <li>Total reported Scope 3 emissions are estimated on an equity basis for downstream GHG emissions. For the upstream GHG emissions component, the boundary is defined on a category-by-category basis due to data limitations.</li> <li>Inventory boundary: Scope 3 emissions.</li> </ul>	<ul style="list-style-type: none"> <li>GHG emissions from maritime transportation not owned or operated by BHP where the transportation was of BHP-produced products sold by BHP. May be BHP-chartered or third-party-chartered. In some cases, the target's boundary may differ from the boundaries under mandatory reporting.</li> <li>Inventory boundary: Scope 3 emissions, Categories 4 and 9, shipping of BHP products only.</li> </ul>	<ul style="list-style-type: none"> <li>Scopes 1 and 2 emissions of our direct suppliers included in BHP's reported Scope 3 emissions reporting categories of purchased goods and services (including capital goods), fuel- and energy-related activities, business travel and employee commuting. In some cases, the target's boundary may differ from the boundaries under mandatory reporting.</li> <li>Inventory boundary: Scope 3 emissions, Categories 1, 3, 6 and 7 (subset) emissions are being used as a proxy for the Scopes 1 and 2 emissions of our direct suppliers.</li> </ul>
<b>Exclusions</b>	Refer to exclusions for our shipping and suppliers' targets.	<ul style="list-style-type: none"> <li>GHG emissions from maritime transportation not owned or operated by BHP, but chartered and paid for by BHP, where the transportation was of third-party-produced products sold by BHP (pursuant to our third-party-trading activity).</li> <li>GHG emissions from maritime transportation not owned or operated by BHP, but chartered and paid for by BHP or a third-party, where the transportation was of products purchased by BHP.</li> </ul>	Scope 3 emissions (for our direct suppliers) associated with our purchased goods and services (including capital goods), fuel- and energy-related activities, business travel and employee commuting.
<b>GHGs included</b>	Defined by the available data, which differs by Scope 3 emissions category. We intend to continue to improve our GHG emission calculations over time to encompass specific greenhouse gases as data becomes available.	CO <sub>2</sub> , CH <sub>4</sub> , N <sub>2</sub> O	Defined by the available data, which differs by Scope 3 emissions category. We intend to continue to improve our GHG emission calculations over time to encompass specific greenhouse gases as data becomes available.
<b>Offsetting</b>	We anticipate offsetting by our customers, suppliers and other third parties will play a role in meeting our long-term net zero goal (and potentially our long-term net zero targets), particularly for residual GHG emissions in steelmaking which are not currently expected to reach zero by CY2050. Where third parties offset their GHG emissions that appear in our reported Scope 3 emissions inventory, we plan to recognise and report the net GHG emissions after offsetting. Carbon credits sourced by third parties in our value chain and associated with GHG emissions that appear in our reported Scope 3 emissions inventory would need to be high-integrity before we recognised that offsetting in our reporting.		
<b>Measurement approach</b>	Description of the calculation methodology used for each Scope 3 emissions category can be found in the BHP GHG Emissions Calculation Methodology 2024, available at <a href="http://bhp.com/climate">bhp.com/climate</a>	Vessel- and voyage-specific GHG emissions calculated using maritime transport emission factors from EU Regulation 2023/1805.	As a proxy for measurement of the Scopes 1 and 2 emissions of our direct suppliers, progress is currently measured using Categories 1, 3, 6 and 7 emissions data using a mix of spend-based and activity-based methodology.

	Value chain long-term net zero goal	Shipping long-term net zero target	Direct suppliers long-term net zero target
<b>Key adjustments made to reference year and subsequent data</b>	Category 1, Category 3, Category 4 (maritime component), Category 9 (maritime component), Category 10, Category 11 and Category 15 GHG emissions in reference year and performance data have been adjusted for the divestment of our interest in Cerrejón (with an effective economic date of 31 December 2020), divestment of our interest in BMC (completed on 3 May 2022), divestment of our interest in the Rhourde Ouled Djemma (ROD) Integrated Development (completed in April 2022), divestment of our Petroleum business (merger with Woodside completed on 1 June 2022), BMA's divestment of the Blackwater and Daunia mines (completed on 2 April 2024) and acquisition of OZ Minerals (completed on 2 May 2023). The remaining categories have not been adjusted due to their immateriality to our long-term net zero goal.	Category 4 (maritime component) and Category 9 (maritime component) GHG emissions in reference year and performance data have been adjusted for a methodology change to use maritime transport emission factors from EU Regulation 2023/1805, after The British Standards Institution (BSI) EN 16258 standard (the source of the emission factors we previously used) was withdrawn in CY2023, and have been adjusted for the divestment of our interest in BMC (completed on 3 May 2022), divestment of our Petroleum business (merger with Woodside completed on 1 June 2022), BMA's divestment of the Blackwater and Daunia mines (completed on 2 April 2024) and acquisition of OZ Minerals (completed on 2 May 2023).	Category 1 and Category 3 GHG emissions in reference year and performance data have been adjusted for the divestment of our interest in BMC (completed on 3 May 2022), divestment of our Petroleum business (merger with Woodside completed on 1 June 2022), BMA's divestment of the Blackwater and Daunia mines (completed on 2 April 2024) and acquisition of OZ Minerals (completed on 2 May 2023). Categories 6 and 7 were not adjusted due to their immateriality to our long-term net zero target.
<b>Target/goal setting method</b>	Set as a point in time, i.e. with the specific date of 'by CY2050' to reach the target or goal of net zero, while reflecting the challenges and uncertainty and our inability (as BHP alone) to ensure Scope 3 emission reductions. As a result, the target or goal is not based on a trajectory and does not imply a specific carbon budget, and Scope 3 emissions may fluctuate (with some increases and/or non-linear decreases) during the period before the target or goal date.		
<b>Target/goal derived using a sectoral decarbonisation approach</b>	No		
<b>Process for reviewing the setting of the target/goal</b>	The Board approves BHP's significant social, community and sustainability policies (upon recommendation from the Nomination and Governance Committee), including those related to climate change and climate transition planning, public sustainability goals and targets (including for GHG emission reductions). We review our GHG emissions targets and goals as part of the periodic development of an updated CTAP, or more frequently if required.		
<b>Process for monitoring progress towards the target/goal</b>	Monitored on a yearly basis through our annual reporting processes, with progress reviewed by management and the Board as part of publication of our annual reporting disclosures, or more frequently if required.		
<b>Third-party validation of our target/goal</b>	No, but we obtain limited assurance over our externally reported performance against our targets and goal.		
<b>Carbon budget for target/goal period</b>	Our targets and goal are not based on trajectories and do not imply specific carbon budgets.		
<b>Expected progression</b>	Progress towards our targets and goal is expected to be non-linear and affected by organic changes in our production of commodities.		

## 6.10 Environment and nature

We acknowledge nature, including biodiversity, is deteriorating worldwide at unprecedented rates. We are supportive of global efforts to halt and reverse nature loss in the coming decade, following adoption of the Kunming-Montreal Global Biodiversity Framework during the Conference of the Parties to the Convention on Biological Diversity in December 2022. We recognise that to help enable the energy transition, critical minerals production will need to increase, and it will be essential that this production meets high standards of environmental stewardship. BHP's business, our suppliers and customers, Indigenous peoples and the local communities where we operate, all depend on and enjoy nature and the ecosystem services it provides. We acknowledge the nature of our operations and our environmental performance can impact the natural environment, including the provision of ecosystem services.

Our *Environment Global Standard* outlines the minimum requirements for managing our environmental risks and complying with our environmental obligations using environmental management systems aligned to ISO14001. We are working to enable these systems to better support our approach to environmental management and performance. The *Environment Global Standard* also describes our requirement to apply the mitigation hierarchy (avoid, mitigate, rehabilitate, compensatory actions) in our approach to managing environmental risks. Our Risk Framework supports how we seek to identify, assess and manage environmental risks, as well as our strategic decision-making.

**>For more information on BHP's approach to water stewardship, biodiversity and land, including associated strategies refer to the following sections and [bhp.com/water](https://www.bhp.com/water) and [bhp.com/biodiversity](https://www.bhp.com/biodiversity)**

### What do we mean by nature and its associated terms?

- The Recommendations of the Taskforce on Nature-related Financial Disclosures (TNFD Recommendations), which were finalised in September 2023, describe nature as having four major components or realms: land, fresh water, ocean and atmosphere – each of which interact with people and society. Biodiversity is a characteristic of all four realms. At BHP, we are continuing to evolve our sustainability-related reporting to align with this concept of nature.
- BHP adopts the definitions as outlined in the TNFD Glossary version 1.0 for the following key nature-related terms: Nature, Nature-positive, Natural Capital, Biodiversity, Realm, Ecosystem function and Ecosystem services. We intend to review these definitions in FY2025, in light of the recently revised TNFD Glossary Version 2.0 (June 2024).

Biodiversity is an essential characteristic of adaptable, resilient and functional ecosystems, which provides society with ecosystem services on which we rely – clean water, fresh air, productive soils, pollination, climate regulation and climate physical risk mitigation; and services through which we enjoy recreation, amenity, spiritual connection and wellbeing.

For definitions refer to **Additional information 10.4** and the TNFD's version 1.0 glossary at [tnfd.global/publication/glossary/](https://tnfd.global/publication/glossary/)



### Nature-related goal and targets

We have set, and are now focusing on the steps required to achieve, our 2030 Healthy environment goal and our context-based water targets (refer to the Fresh water and oceans section later in OFR 6.10) that are designed as part of our contribution towards the global efforts to reduce and/or reverse nature loss.

Our 2030 Healthy environment goal, announced in 2022, is to create nature-positive<sup>1</sup> outcomes by having at least 30 per cent of the land and water we steward<sup>2</sup> under conservation, restoration or regenerative practices by the end of FY2030. Our focus is on areas of highest ecosystem value, both within and outside our own operational footprint, in partnership with Indigenous peoples and local communities.

Our 2030 Healthy environment goal was developed in anticipation of the Kunming-Montreal Global Biodiversity Framework. We focus our activities in support of achieving this goal on the large areas of non-operational land we steward, as this land offers the greatest opportunity for us to apply conservation, restoration or regenerative practices at a larger scale. Our Healthy environment goal and the mitigation hierarchy are considered as part of the factors we use to inform management approaches for our operational and non-operational areas.

To meet the FY2024 short-term milestone for the Healthy environment pillar of our social value scorecard, we have developed a Group-level framework for nature-positive plans to achieve the 2030 Healthy environment goal (BHP Healthy environment goal roadmap).<sup>4</sup> We intend to assess the potential opportunities identified in the BHP Healthy environment goal roadmap to inform business decisions designed to enable BHP to progress towards our 2030 Healthy environment goal.

As at 30 June 2024, we had 83,012 hectares or 1.62 per cent<sup>5</sup> of the land and water that we steward<sup>2,7</sup> under nature-positive management practices<sup>3</sup> compared to 79,718 hectares or 1.56 per cent at the end of FY2023.<sup>6</sup> The FY2024 area under nature-positive management practices<sup>3</sup> has increased by 3,295 hectares (or 4.13 per cent) since FY2023.

The increase in area under nature-positive management practices in FY2024 compared to FY2023 is due to: the inclusion of areas under nature-positive management practice at the former OZ Minerals operation Carrapateena and the West Musgrave project, not included in our FY2023 reporting; an additional regulatory conservation area at one of BMA's assets in FY2024; and BMA's divestment of the Blackwater and Daunia mines,<sup>7</sup> resulting in these areas, including some areas reported in FY2023 as under nature-positive management practices,<sup>3</sup> being excluded from the land and water we steward.<sup>2</sup>

The calculation for the area under nature-positive management practices includes areas under regulatory and voluntary conservation and restoration, and regenerative agriculture. A breakdown of this can be found in the BHP ESG Standards and Databook 2024. We plan to continue to assess, validate and disclose material information regarding the Healthy environment goal calculation methodology, in consideration of evolving external frameworks and stakeholder expectations.

**>For more information on our Healthy environment goal methodology and natural capital metrics framework, how the BHP Healthy environment goal roadmap was developed using a targeted version of the TNFD's LEAP approach, and examples of areas under nature-positive management practice refer to [bhp.com/environment](https://bhp.com/environment)**

**>For more information on our 2030 goals refer to OFR 6.5**

**>For more information on how we manage risk refer to OFR 8**

#### Footnotes

1. Nature-positive is defined by the TNFD Glossary version 1.0 as 'A high-level goal and concept describing a future state of nature (e.g. biodiversity, ecosystem services and natural capital) which is greater than the current state'. We understand it includes land and water management practices that halt and reverse nature loss – that is, supporting healthy, functioning ecosystems. BHP intends to review this definition in FY2025, in light of the recently revised TNFD Glossary version 2.0 (June 2024) definition of nature positive.
2. This excludes areas we hold under greenfield exploration licences (or equivalent tenements), which are outside the area of influence of our existing mine operations. 30 per cent will be calculated based on the areas of land and water that we steward at the end of FY2030.
3. Nature-positive management practices refer to an area under stewardship that has a formal management plan that includes conservation, restoration or regenerative practices. For more information refer to the BHP ESG Standards and Databook 2024, available at [bhp.com/sustainability](https://bhp.com/sustainability).
4. The BHP Healthy environment goal roadmap is intended to apply to our operated assets in Australia, Chile and Canada. Due to the acquisition of OZ Minerals and prioritisation of activities based on risks and impacts, Carrapateena, Prominent Hill, West Musgrave and legacy assets are currently out of scope for the roadmap; with the exception of West Musgrave, these assets are planned to be incorporated into the roadmap in FY2025. Incorporation of West Musgrave into the BHP Healthy environment goal roadmap will be reviewed following the decision to temporarily suspend the Western Australia Nickel operations.
5. 1.62 per cent is calculated based on the areas of land and water that we stewarded (excluding areas we hold under greenfield exploration licences (or equivalent tenements) and subject to footnote 7) at 30 June 2024 – which was approximately 5,125,935 hectares; an increase of approximately 18,750 hectares compared to approximately 5,107,185 hectares at 30 June 2023.
6. FY2023 values are a restatement of our previously reported 1.3 per cent and 82,132 hectares. The restatement from 82,132 to 79,718 hectares under nature-positive management practices for FY2023 is due to a change in our methodology and associated definitions; with FY2023 values being reported based on GRI Biodiversity 2016 304-3 definitions. The restatement from 1.3 per cent to 1.56 per cent area under nature-positive management practices<sup>3</sup> is primarily due to approximately 1.5 million hectares of greenfield exploration licences, which are located outside the area of influence of our existing mine operations, being incorrectly assigned to 'the land and water we steward'<sup>2</sup> component of the Healthy environment goal calculation in FY2023.
7. While some of the land related to the Daunia and Blackwater mines is pending transfer following BMA's divestment of these mines on 2 April 2024, these areas are no longer under BMA's control or operated for BMA's benefit so have been excluded from the areas of land and water we stewarded at 30 June 2024.

## Nature-related risk and impact management

Our approach to biodiversity and nature recognises the five key drivers of nature loss (changes in land and sea use, direct exploitation of natural resources, pollution, climate change, invasive species), as outlined by the United Nations Environment Programme (UNEP).

Our primary approach to preventing or minimising our adverse impacts to nature (including air, fresh water and oceans, land and biodiversity) within our operational footprint is to apply the mitigation hierarchy. For an example of how we apply the 'avoid' pillar refer to our environmental-related commitments below.

**>For more information on governance of sustainability topics, including nature, refer to OFR 6.3.**

### Our environmental-related commitments are:

- We do not explore or extract resources within the boundaries of World Heritage listed properties.
- We do not explore or extract resources adjacent to World Heritage listed properties, unless the proposed activity is compatible with the outstanding universal values for which the World Heritage property is listed.
- We do not explore or extract resources within or adjacent to the boundaries of the International Union for Conservation of Nature (IUCN) Protected Areas Categories I to IV, unless a plan is implemented that meets regulatory requirements, takes into account stakeholder and partner (including Indigenous peoples) expectations and contributes to the values for which the protected area is listed.
- We do not operate where there is a risk of direct impacts to ecosystems that could result in the extinction of an IUCN Red List Threatened Species in the wild.
- We do not dispose of mined waste rock or tailings into a river or marine environment.
- We do not use aqueous film forming foams (AFFF) containing per- and poly-fluoroalkyl substances (PFAS) at our operated assets. We replace with fluorine free foam products.

The requirement to apply the mitigation hierarchy, our environmental-related commitments and other Group-wide approaches to environmental management are set out in our *Environment Global Standard* and in mandatory minimum performance requirements for risk management. We released an updated *Environment Global Standard* in April 2024 and key changes include:

- an increased focus on risk and impact management:
  - I. extends requirements for identifying and assessing nature-related risks to include those within BHP's supply chain
  - II. requires consideration of impacts and dependencies, physical risks, systemic risks and transition risks when assessing nature-related risk
  - III. emphasises application of the mitigation hierarchy when identifying, assessing and implementing environment-related controls
- a new requirement to develop and implement asset-level nature-positive activities and to include these activities within the BHP Healthy environment goal roadmap
- a new environmental-related commitment to cease use of aqueous film forming foams (AFFF) that contain per- and poly-fluoroalkyl substances (PFAS) (a key FY2024 action to reduce our impact associated with one of the five major drivers of nature loss, pollution)
- enhanced rehabilitation planning commitments

We are prioritising managing our nature-related risks (including impacts, dependencies, threats and opportunities) within the land and waters we steward. In FY2024, BHP commissioned work to improve our process for how we understand and manage nature-related risk in the value chain.

In FY2024, BHP also introduced a new Global Land Use Permitting (GLUP) system. GLUP is a global software solution developed inhouse to support the internal end-to-end compliance requirements of our Land Use Permit process, which is a key control to manage land use disturbance risks and support application of the avoid and minimise steps of the mitigation hierarchy. This solution was designed to support the Land Use Permit owners and contributors to better understand their obligations and how to manage BHP's risk to cultural heritage, environment and biodiversity through a simple, transparent and collaborative global technology system.

**>For more information on the updated list of nature-related impacts and dependencies that have been evaluated as part of the development of the BHP Healthy environment goal roadmap refer to [bhp.com/environment](https://bhp.com/environment)**

**>For more information on the water-related risks (including impacts, dependencies, threats and opportunities) we take to seek to prevent, mitigate or enhance them refer to [bhp.com/water](https://bhp.com/water)**

**>For our overarching approach to risk management refer to OFR 8**

**>For more information on our environmental approach refer to the *Environment Global Standard* and our nature-related management and governance processes at [bhp.com/environment](https://bhp.com/environment)**

## Fresh water and oceans

Water is integral to what we do and vital to the longevity of BHP. We depend on access to water and cannot operate without it. Our Water Stewardship Position Statement outlines our vision for a water secure world by 2030, an aim consistent with the United Nations Sustainable Development Goal 6, and considers ecosystem health, cultural and spiritual values, human rights, communities, Indigenous peoples and economic growth among other factors. Our position statement is supported by our Water Stewardship Strategy, which focuses on understanding and managing water-related risk, disclosure, contributing to the resolution of shared water challenges, valuing water and sharing innovations and learning.

Water data and accounting relies on a variety of data sources, including from water modelling, direct measurement and estimation techniques based on available known methodologies (e.g. estimation of evaporation from water storages). Recognising that the water models, water balances and assumptions used in our water accounting approach contain inherent uncertainty; and in line with our commitment to continuous improvement; we continue to review the assumptions and refine our methodology of our water accounts and data.

	In FY2024, seawater continued to be our largest source of water withdrawal (58 per cent in FY24 compared to 52 per cent in FY2023); groundwater (a mixture of high- and low-quality water) remained our most significant non-seawater source (23 per cent in both FY2024 and FY2023).
	The volumes withdrawn in FY2024 represent approximately 28 gigalitres (GL) or 7 per cent reduction in water withdrawal compared to FY2023. This was primarily due to a reduction in high-quality Type 2 surface water (precipitation and run-off) withdrawal from our BMA and NSWEC assets, attributable to a decrease in rainfall at those operational areas.
 	Total water withdrawals from operated assets located in high or very high water-stressed areas (as determined by WWF Water Risk Filter) was 33,330 megalitres (ML) (9 per cent of total withdrawals for BHP operated assets) compared to 35,340 ML (and 9 per cent) in FY2023; and consisted of 81 per cent high-quality (Type 1 and 2) water compared to 69 per cent in FY2023. This is primarily due to increased Type 2 water withdrawal at Pampa Norte, which is sourced from third-party desalinated water (i.e. the original source of this water is Type 3). Over the same period, Pampa Norte's Type 3 water withdrawal from third-party surface water decreased from approximately 6,090 ML to approximately 3,350 ML. This is in line with Pampa Norte's water strategy and context-based water target milestones to cease operational use of terrestrial water sources from water scarce areas.
	In FY2024 the significant decrease in water re-use and recycling at Pampa Norte was primarily due to a change in the methodology for calculating reused and recycled water, using measured values in calculations instead of estimations.

Key:  Ocean-related performance update  Fresh water-related performance update  Recycled water-related performance

We continue to seek opportunities to source our water from lower-grade sources rather than use high-quality water resources from the catchments where we operate. Key insights from our FY2024 water performance are outlined above.<sup>1</sup>

In FY2024, we commenced review and refinement of our water accounts and model at our Western Australia Nickel asset, completing a review at Mount Keith. Updates to Leinster's water model are planned to be rolled out in FY2025. The continuation of this program will be subject to review, and there is no current plan to disclose water data from West Musgrave in the future, following the announcement of temporary suspension of operations at Western Australia Nickel. In FY2025, we also intend to align Prominent Hill and Carrapateena to ICMM's Water Reporting, Good Practice Guide (2nd Ed) and the Minerals Council of Australia's Water Accounting Framework, to enable disclosure of water data from these operations from FY2026.

### Context-based water targets

In our Water Stewardship Position Statement, we committed to develop context-based water targets (CBWTs). These targets were informed by BHP's view of water-related risks in the relevant catchment and by the shared water challenges identified in the Water Resource Situational Analysis (WRSA). A WRSA is a holistic assessment and summary of the sustainability, governance, and social, cultural, spiritual, environmental and economic values of water (fresh or marine) within a defined catchment area, which provides a rounded understanding of the shared water challenges and collective action opportunities for the catchment. The CBWTs aim to improve our internal BHP water management and contribute to collective benefit and shared approaches to water management in the regions where we operate. Our CBWTs support BHP's 2030 Healthy environment goal and are expected to contribute to the protection or restoration of water-dependent ecosystems in the vicinity of our operated assets. The CBWTs are underpinned by a series of milestones and we delivered all asset-level CBWT<sup>2</sup> FY2024 short-term milestones except one at West Australia Nickel, as summarised above.

In FY2024, we engaged third parties (e.g. universities) to undertake a WRSA at NSWEC, including to review publicly available information and engage with partners and stakeholders (e.g. communities, Indigenous groups, policymakers and other private corporations within our catchment areas). Shared water challenges were identified through a WRSA. NSWEC's WRSA was released in August 2024. CBWTs for NSWEC and one of our legacy assets are planned to be released in FY2025.

### Footnotes

1. Water performance data does not include Carrapateena or Prominent Hill operations.
2. CBWTs are intended to apply at the asset level for our operated assets. Due to the previous divestment review of NSWEC, along with CBWTs for our legacy assets in the United States and Canada, CBWTs for NSWEC and at least one legacy asset area are planned to be released in FY2025. BHP plans to review the suitability of the existing Olympic Dam WRSA and CBWTs during FY2025, following the creation of the Copper South Australia asset, inclusive of Olympic Dam, Carrapateena and Prominent Hill. We expect to review the need to revise or create CBWTs when there are substantial changes to our portfolio or one of our projects moves into the operational phase. The Western Australia Nickel context-based water targets do not include the West Musgrave Project.

**Progress against FY2024 context-based water target milestones**

	FY2024 milestone	Progress
<b>BMA</b>	Make available unutilised <sup>1</sup> RMA water allocations to the temporary water trading market for each year from FY2024	☑ This milestone was <b>achieved</b> in FY2024. 3.05GL of water allocations was traded on the temporary water trading market in FY2024.
<b>Escondida and Pampa Norte</b>	Cease extraction of terrestrial water for Cerro Colorado operational use	☑ This milestone was <b>achieved</b> in FY2024. Extraction for operational use ceased December 2023.
<b>Nickel West<sup>2</sup></b>	Facilitate establishment of a Northern Goldfields catchment regional water working group	☹ While activities have been undertaken in line with the intent of the FY2024 short-term milestone, this milestone <b>has not yet been achieved</b> . The Northern Goldfields catchment regional water working groups are being established by local native title holders, and Nickel West actively collaborated in this process throughout FY2024.
<b>Olympic Dam</b>	Implement a permanent daily abstraction limit on Wellfield A at 5ML/d	☑ This milestone was <b>achieved</b> in FY2024. Daily abstraction from Wellfield A remained below 5ML/d throughout FY2024.
<b>Western Australia Iron Ore</b>	Initiate and support a collaborative scoping study for a regional water data sharing solution	☑ This milestone has been <b>achieved</b> in FY2024. Terms of Reference for the Weeli Wolli Catchment Industry Collaboration group, coordinated by the Chamber of Minerals and Energy, have been agreed. BHP funding has been committed to support shared environmental analytics incorporating a catchment scale integrated groundwater database in the Pilbara.

1. Some water allocations at BMA are not made available for sale 'in year' and are retained for strategic contingency purposes as 'carry over'. Unutilised 'carry over' is subject to ongoing assessment throughout the year as to what can be made available. At 30 June any unused 'carry over' amounts are incorporated into the following financial years 'in year' water for the total river scheme's announced allocations by the Resource Operator.

2. The existing commitment to develop an 'action to improve BHP's water performance' CBWT in the future will be reviewed following the decision to temporarily suspend Western Australia Nickel operations. The Western Australia Nickel context-based water targets do not include the West Musgrave Project.

Beyond BHP's footprint, we made voluntary contributions to support environmental resilience across the regions where we operate, including through thought leadership and action on the ground. For example, in FY2024:

- We continued to collaborate with the University of Notre Dame to develop a framework for corporations and policymakers to consider the human right to water to support social equity and reduce corporate risk. During FY2024, work continued to make the framework more practical by developing decision support tools and case studies.
- We continued to progress with the Groundwater Modelling Decision Support Initiative (GDMSI) with partner organisations Rio Tinto and Flinders University to help promote the application of advances in groundwater modelling for environmental and water management decisions. During FY2024, the initiative reviewed the application of numerical groundwater modelling in environmental assessments and delivered a discussion paper on some of the challenges associated with disclosing and addressing technical uncertainty in decisions.
- BMA has been a member of the Fitzroy Partnership for River Health and Mackay Whitsunday Isaac Healthy Rivers to Reef Partnership since 2020 and 2022 respectively, contributing over A\$0.55 million to these partnerships in FY2024. One of the key goals of these partnerships is to provide a more complete picture of river and marine health – providing funding, resources and contributing water quality and ecosystem health monitoring data through data-sharing arrangements. In FY2024, the Mackay Whitsunday Isaac Healthy Rivers to Reef 'Project Blueprint', water quality monitoring and engagement in the Whitsundays, was expanded to include direct Traditional Owner participation. Project Blueprint has completed over 12 trips and analysed over 360 samples.

**>>For more information on the Fitzroy Partnership for River Health and Mackay Whitsunday Isaac Healthy Rivers to Reef Partnership, including annual report reports, refer to [riverhealth.org.au](http://riverhealth.org.au) and [healthyriverstoreef.org.au](http://healthyriverstoreef.org.au)**

>[bhp.com/water](https://www.bhp.com/water) and [bhp.com/sustainability/environment/water/shared-water-challenges](https://www.bhp.com/sustainability/environment/water/shared-water-challenges)

> [NSWEC's WRSA is available at bhp.com/sustainability/environment/water/shared-water-challenges/what-is-wrsa](https://www.bhp.com/sustainability/environment/water/shared-water-challenges/what-is-wrsa)

> [Detailed information on water accounting and reporting of metrics required by the ICMM Guidance is available at bhp.com/water](https://www.bhp.com/water)

> [For more information on our water performance in FY2024 and case studies on activities we are undertaking to progress towards meeting our water stewardship vision refer to bhp.com/water](https://www.bhp.com/water)

## Biodiversity

In accordance with the 2022 Kunming-Montreal Global Biodiversity Framework BHP acknowledges biodiversity is fundamental to human wellbeing, a healthy planet, and economic prosperity for all people.

We have a Group-level biodiversity strategy that outlines our purpose and strategic priorities, and is designed to inform operational decision-making across the full lifecycle of mining operations at our operated assets. The Group-level strategy provides a clear direction that enables alignment of asset-level biodiversity and land objectives and supports delivery of the 2030 Healthy environment goal. The focus areas in the biodiversity strategy are valuing natural capital, innovation and collaboration, and nature-related disclosures.

Our work on understanding and managing the value of nature to our business and to the communities where we operate continues to progress following the completion of our pilot natural capital accounting (NCA) case study at our Beenup site in Western Australia in FY2023. Further NCA piloting was performed in FY2024 at our Olympic Dam operation, as part of a broader project led by Cooperative Research Centre for Transformations in Mining Economies (CRC TiME) and CSIRO, with input from the Australian Government Department of Climate Change, Energy, the Environment and Water, and other CRC TiME partners. This project provided inputs to a suite of new resources that has been released to support the mining industry adopting NCA – a way of accounting for impacts on nature over the life of projects. The Olympic Dam pilot case study provided new insights into what is possible using industry data at an operating asset and revealed the need for a clear underlying rationale to inform the design of decision-useful natural capital accounts.

The BHP Healthy environment goal roadmap includes a preliminary natural capital metrics framework, which considers the ecological status and socio-economic value of natural capital assets that we impact and/or depend on. It was applied in FY2024 to establish the initial metrics that are intended to be used to measure the impact of BHP's nature-positive management practices.

Beyond BHP's footprint, we made voluntary contributions to support environmental resilience across the regions where we operate, including through on-ground action. For example:

- In FY2024, we finalised our four-year coral reef restoration project with the Woppaburra Traditional Owners, who are the custodians of Sea Country adjacent to our BMA operations in the southern Great Barrier Reef. The project was co-designed by Woppaburra people with some attaining qualifications in coral aquaculture techniques that have led to employment opportunities. Our pilot of the Seascape Framework, which is one of the world's largest Indigenous created and managed marine conservation initiatives, continued with Conservation International in Lau, Fiji.
- In FY2024, we renewed our fourth extension of the Bush Blitz Project for a further five years to the end of FY2030. Bush Blitz is Australia's largest nature discovery program – a unique multi-million-dollar partnership between BHP, the Australian Government and Earthwatch Australia to document plants and animals across the country. Since the program began in 2009, Bush Blitz has discovered more than 2,100 new species and has added thousands of species records to what is already known. Phase 3 of the program, from 1 June 2018 to April 2024, involved 15 field expeditions, which covered 2,966,495 hectares of land and almost 62 square kilometres of sea, making a major contribution to the understanding and conservation of Australia's biodiversity. During these expeditions, Bush Blitz scientists – supported by BHP employees and educators serving as field research assistants – discovered 311 species new to science. The surveys also engaged hundreds of Indigenous rangers, Traditional Owners, park rangers and other land managers. In particular, Bush Blitz has undertaken research on Indigenous-managed properties, creating positive cultural exchange and learning opportunities for rangers and scientists.
- Since FY2021, we have partnered with Curtin University on the use of environmental DNA (eDNA) as a novel biomonitoring tool to enable the development of ecosystem condition indices. We have supported five pilot studies that focus on protected species (e.g. the Pilbara olive python), subterranean conservation research, functional ecology of the Chilean wetlands of the Altiplano, and studies to develop new assays that can be used to detect invasive marine species. This work was extended in FY2024 to include research into sampling eDNA from soil and air. In terms of impact, the research has produced 22 scientific publications, supported six post-graduate students, sequenced the first complete genome of the Pilbara olive python, added 391 marine sequences to GenBank, and assembled over 150 new mitochondrial genomes. A Funding Agreement for a further four years of ongoing eDNA research with Curtin University was signed in FY2024.



>For more information on our 2030 goals refer to OFR 6.5 and for information on our biodiversity strategy refer to [bhp.com/biodiversity](https://bhp.com/biodiversity)

>For more information on our approach to biodiversity and land management and case studies on activities we are undertaking to progress towards meeting our biodiversity aims refer to [bhp.com/biodiversity](https://bhp.com/biodiversity)

>For more information on the CRC TiME and CSIRO NCA project and resources refer to [crctime.com.au/blog/media-release-new-reports-to-help-test-applicability-of-natural-capital-accounting-in-australias-mining-sector/](https://crctime.com.au/blog/media-release-new-reports-to-help-test-applicability-of-natural-capital-accounting-in-australias-mining-sector/)

## Land

As at 30 June 2024, BHP owned, leased or managed approximately 8,874,555 hectares of land compared to approximately 8,038,027 hectares as at 30 June 2023. The approximately 836,528-hectare increase is primarily due to the incorporation of former OZ Minerals Australian land holdings. Approximately 2 per cent (approximately 144,634 hectares) of this area has been disturbed for mining operation purposes and approximately 16 per cent (approximately 22,885 hectares) of land we have disturbed is currently rehabilitated.

Most of the area we steward is located in Australia and is for non-operational land uses, such as pastoral leases or land set aside for conservation. BHP's approach to environmental management is tailored to different area types in our portfolio. See Figure below for a visualisation of this.

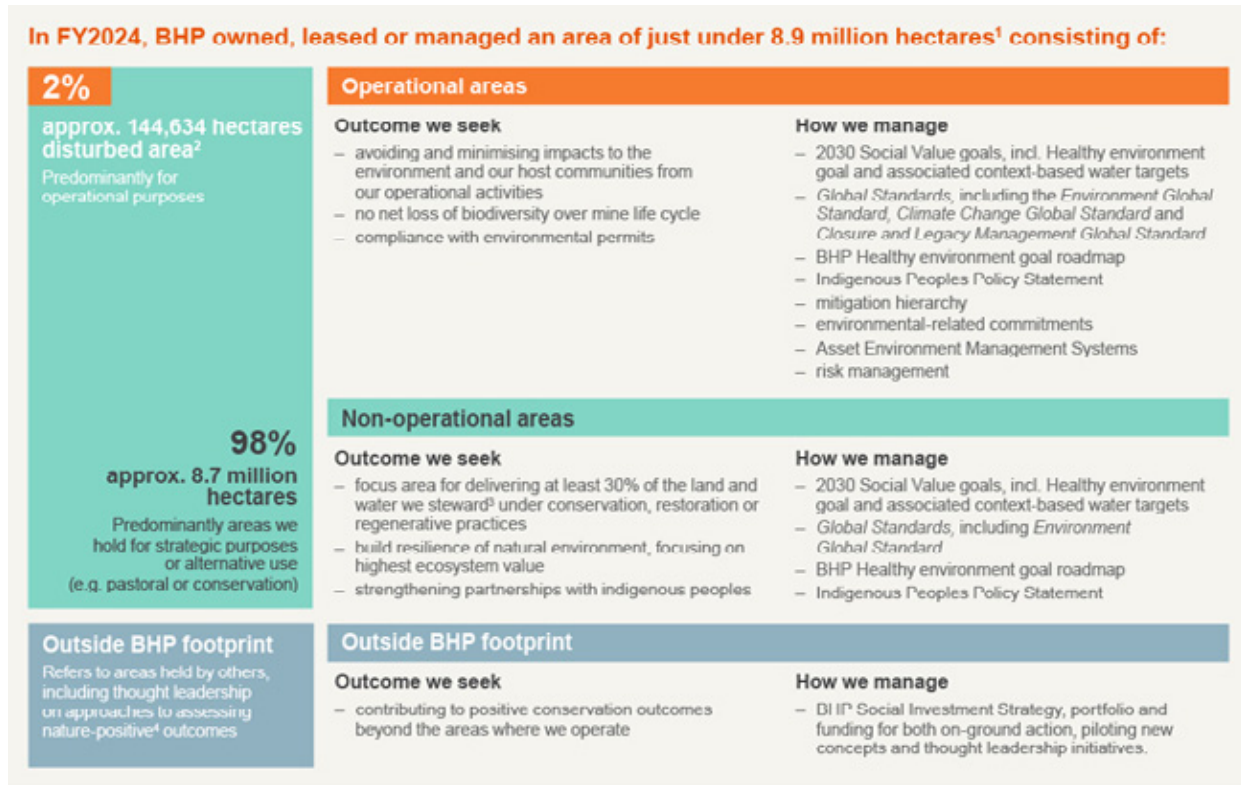

### Infographic footnotes:

1. Land data is calculated as the total area of land owned, leased or managed by BHP at 30 June 2024. This value includes greenfield exploration licences (or equivalent tenements), which are outside the area of influence of our existing mine operations. Land associated with the Daunia and Blackwater mines is excluded, as the mines were divested by BMA during the year. While some of the land related to the Daunia and Blackwater mines is pending transfer following completion on 2 April 2024, it is no longer under BMA's control or operated for BMA's benefit and has been excluded on that basis.
2. Note that this was incorrectly stated in the FY2023 Annual Report as 'operational area – the area we hold for mining', rather than 'disturbed area, predominantly for operational purposes'.
3. This excludes areas we hold under greenfield exploration licences (or equivalent tenements), which are outside the area of influence of our existing mine operations. 30 per cent will be calculated based on the areas of land and water that we steward at the end of FY2030.
4. Nature-positive is defined by the TNFD Glossary version 1.0 as 'A high-level goal and concept describing a future state of nature (e.g. biodiversity, ecosystem services and natural capital) which is greater than the current state'. We understand it includes land and water management practices that halt and reverse nature loss – that is, supporting healthy, functioning ecosystems. BHP intends to review this definition in FY2025, in light of the recently revised TNFD Glossary version 2.0 (June 2024) definition of nature positive.

## Atmosphere and air quality

Clean air is crucial for the health of our people, our host communities and the surrounding ecosystems. We are actively working to improve air quality management, with a focus on managing emissions of particulate matter from our operations.

Our emission of nitrous oxides, particulates and sulphur dioxide is considered non-material in comparison to global emissions as determined by the GRI materiality assessment process. We have extensive particulate monitoring and management programs at some of our operated assets. We report air emissions (such as nitrous oxides) as part of the BHP ESG Standards and Databook 2024, available at [bhp.com/sustainability](https://bhp.com/sustainability), and discuss our approach and management to these on our environment webpage at [bhp.com/environment](https://bhp.com/environment).

**>For more information on our approach to air quality refer to the Pilbara Air Quality Program case study at [bhp.com/sustainability/environment](https://bhp.com/sustainability/environment)**

### Environmental legal cases

We have settled ongoing legal cases involving environmental matters for our operated assets. Examples for Lagunillas (Cerro Colorado) and Monturaqui (Escondida) are described below.

Nine fines were issued and paid in FY2024 in relation to environmental laws and regulations at our operated assets. For more information refer to the 2024 ESG Standards and Databook.

#### Lagunillas (Cerro Colorado)

In 2021, an individual filed an environmental damage claim against Cerro Colorado (CMCC) before the First Environment Court of Antofagasta, alleging CMCC's water extraction from the Lagunillas aquifer had damaged the aquifer, as well as a nearby lagoon and wetlands. The substantive case was heard in FY2022. In November 2023, the Environmental Court approved the settlement submitted by the parties, concluding that the environmental remediation measures in the agreement are adequate.

#### Monturaqui (Escondida)

In March 2022, the Chilean Environmental Regulator (SMA) sanctioned Escondida, concluding it had breached its environmental permit causing irreparable environmental damage due to its water extraction from the Monturaqui aquifer. In March 2022, the SMA imposed a fine of approximately US\$8.3 million. In February 2023, Escondida filed an appeal before the First Environmental Court seeking to annul the SMA decision. The appeal is pending.

Shortly after the March 2022 SMA decision, two related environmental damage claims were filed in the First Environment Court of Antofagasta. Following a hearing in July 2023, the Court is now in a position to render a ruling on the claims' merits, which we expect could occur within the next 12 months.

### Engagement

Beyond our operational activities, we engage across communities, Indigenous peoples' representatives, government, industry association memberships, our customers and suppliers, business and civil society on a range of topics related to environmental management.

Through our engagement in industry associations, we have provided input into their advocacy with governments on behalf of industry. In FY2024, our focus within industry has been on streamlining approvals and permits whilst maintaining environmental standards; recognising environmental, social and economic factors must be considered in these processes. Specific examples include:

- direct and indirect engagement, via the Minerals Council of Australia, with the Australian Government on its Nature Positive law reforms, outlining our alignment with the government's intent to reform the current national environmental laws so they achieve the right balance between better outcomes for the environment and supporting economic growth, investment and job creation
- indirect advocacy via the Chilean Mining Council, in relation to a Bill that strengthens environmental management instruments, deepening citizen participation, and providing greater certainty and reduced processing times. We also advocate for the reduction of processing times without weakening environmental standards

We also partner with others to advance the thinking in our priority areas of action. As an International Council on Mining and Metals (ICMM) member, we have worked with industry peers to develop the ICMM's nature position statement with associated commitments, which was adopted by ICMM members in January 2024.

**>For more information on the ICMM nature position statement refer to [icmm.com/en-gb/our-principles/position-statements/nature](https://icmm.com/en-gb/our-principles/position-statements/nature)**

## 6.11 Community

Through our business activities and the social, economic and environmental initiatives that accompany them, we can make a significant contribution to communities where we operate and to society more broadly. Our operations can also generate impacts for host communities that need to be carefully identified, monitored and addressed. This tension challenges us to look for inclusive, innovative and integrated solutions that meet the constantly evolving performance expectations that communities and society hold for us. This means the voice of our community stakeholders remains a critical input into our short-term response and our long-term vision around community engagement, partnership and investment.

In FY2024, we continued to manage relevant risks (threats and opportunities) and impacts as well as progressed development of our longer-term strategic approach to community engagement. This includes an increased focus on seeking to adopt a 'co-creation' approach – involving and providing agency for our partners to shape selected initiatives.

### Co-creation

Co-creation, or co-design, in essence, is a strategic approach involving the integration of diverse partners' resources, knowledge and networks to resolve complex collective challenges or realise more enhanced outcomes through collaboration. It places BHP within a larger ecosystem where stakeholders actively participate in project development and delivery. Stakeholders act as valuable contributors to each design process and ideas generated via co-creation become integral to a company's decision-making process. Throughout this Report we use the terms co-creation and co-design interchangeably.

For the Thriving, empowered communities (TEC) pillar of the social value scorecard, BHP's experience and learning from external sources have demonstrated that integrating a co-creation approach is an opportunity, when adopted in the right circumstances, to generate outcomes that are more valued by Indigenous peoples, communities, governments and civil society through an enhanced sense of ownership and benefit. There are also business benefits to this approach, including enhanced social value outcomes and impact. As such, the TEC pillar focuses on the adoption of the practice of co-designed targets within the 2030 scorecard. In FY2024, we increased our focus on co-creation within our general community approach. This includes commencing the development of criteria that provide guidance on co-design practices, processes and assessments against the social value targets within the TEC pillar of our social value framework.

**>For more information on our social value scorecard, including our co-creation metrics and milestones, refer to OFR 6.5**

### Understanding communities

Our approach to community engagement and research includes:

- Community perception surveys – snapshots of the communities where we operate and stakeholders' perspectives on their community priorities and of sector and BHP performance, completed on a regular basis. As at 30 June 2024, field work for the latest community perceptions survey was underway.
- Community baseline studies – desktop assessments that provide quantitative and qualitative data on social, cultural, economic and political characteristics of the communities where we operate. The most recent baselines were completed in FY2023 and included all operated and legacy assets and our exploration regions at that time. The former OZ Minerals operations will be included in future community baseline studies.
- Community and human rights impact and opportunity assessments (CHRIOAs) – analysis of surveys, baseline studies and community stakeholder feedback against asset plans to identify and prioritise potential and actual risks, impacts and opportunities related to local communities where we operate (see the following section for more details).
- Community engagement and social investment indicators – data collected related to community engagements (e.g. number of community concerns and use of operational grievance mechanisms) and social investment partnerships (e.g. outcome indicators of a particular project) that provide insights to the communities' relationships with us.

We continue to track and report instances of community concerns, complaints and grievances received through our operational grievance mechanisms and other feedback avenues. In FY2024, there were 600 community concerns and complaints received across our operated assets globally. Of note, 462 of these related to a mass submission of email communications received in relation to potential impacts of the BMA Caval Ridge Horse Pit Extension project during the public disclosure period. The nature of the concerns raised were the same in each submission and included potential impacts to flora and fauna, impacts on ground and surface water and the final landform of the project.

The majority of remaining concerns and complaints related to operational issues, such as dust, road and rail impacts, lighting and noise. Asset complaint volumes remained relatively stable from last year's figures with the exception of BMA (attributed to the Horse Pit Extension project submission as detailed above) and a 57 per cent decrease in complaints at NSWEC, through the resolution of an ongoing issue with a single community stakeholder. Ten complaints were made by Indigenous communities in Chile which we are seeking to address through ongoing dialogue with those communities. Concerns, complaints and grievances from communities connected to the former OZ Minerals assets are expected to be incorporated in the BHP Annual Report from FY2025.

In FY2024, we implemented a new enterprise-wide stakeholder management system that enables us to maintain improved records of community engagements and our commitments. This system also incorporates an updated external facing complaints and grievance portal designed to improve accessibility for community members to provide direct feedback to us. We intend to launch the enhanced portal for the system in FY2025. We also updated our internal standards, designed to provide improved guidance for community engagement and social performance leading practice as well as to enhance integration with our existing business processes, such as asset planning and risk assessments.

**>For more information on stakeholder concerns reflecting entries received through our local grievance mechanisms, local stakeholder engagement and ongoing community research, including community perception surveys, refer to the BHP ESG Standards and Databook 2024 at [bhp.com/ESGStandards2024](https://bhp.com/ESGStandards2024)**

We recognise many of the communities where we operate rely on mining and associated activities to support their livelihoods. We aim to ensure change and transitions are equitable and deliberately considered across the lifecycle of our business and for the communities where we operate.

**>For information on our approach to equitable change and transition, including equitable change and transition at our Mt Arthur coal mine, refer to the BHP Climate Transition Action Plan 2024 available at [bhp.com/CTAP2024](https://bhp.com/CTAP2024)**

### Community and human rights impact and opportunity assessments

In FY2024, building on the results of the community and human rights baseline studies completed for all operated assets and certain exploration regions in FY2023, we developed and commenced implementation of a globally consistent methodology for community and human rights impact and opportunity assessments (CHRIOAs), which identified and prioritised potential impacts, risks and opportunities related to the local communities where we operate. The approach was trialled at all our operated assets (excluding the former OZ Minerals assets) and selected exploration regions. This enabled identification of the potential community and human rights impacts and opportunities most prevalent to each region while also supporting a global view of recurring issues, which can help us identify potential opportunities for company-wide action or collaboration. The identified risks, impacts and opportunities are being evaluated and are expected to be embedded within asset and relevant functions' FY2025 risk profiles. The highest priority areas for each operating region are detailed in the map below, with US legacy assets and Exploration prioritising water access and pollution as the key CHRIOA priority risk areas. In FY2025, we plan to further embed the CHRIOA process through the integration of identified risks (threats and opportunities) into asset risk profiles to enable action. We also expect to include the former OZ Minerals assets in this process in future years.

## Prioritised community and human rights issues for operating regions identified in CHRIOAs



As we acquire assets in new areas, we may be exposed to additional human rights risks. For information on our approach to addressing modern slavery risks in our operations and supply chains, refer to the BHP Group Modern Slavery Statement 2024.

**>For more information on our approach to community refer to [bhp.com/communities](https://www.bhp.com/communities)**

### 6.12 Indigenous peoples

Indigenous peoples are important partners for BHP’s activities. Across our Minerals Australia and Minerals Americas activities, BHP operates on or close to the traditional lands of Indigenous peoples and we have a deep respect for their distinct cultures, rights, perspectives and aspirations. BHP is committed to working collaboratively with Indigenous peoples to develop long-term partnerships based on trust and mutual benefit as set out in our Indigenous Peoples Policy Statement. It is through this commitment that we aim to support reconciliation with Indigenous peoples and contribute to improved social, economic and environmental outcomes.

In FY2024, we developed and introduced procedures for projects and new operations to identify and assess the severity of potential adverse impacts to Indigenous peoples’ and to engage and consult Indigenous peoples to understand how we can seek to avoid and mitigate adverse impacts, with the intention of substantially addressing potentially impacted Indigenous peoples’ ambitions and concerns. We have also introduced new procedures for projects and new operations to engage with and seek to obtain ‘free, prior and informed consent’ (FPIC) from potentially impacted Indigenous peoples in accordance with the approach set out in our Indigenous Peoples Policy Statement. Where gaps exist between the host government’s laws and regulations about consultation with Indigenous peoples and BHP’s approach to FPIC, our policies require that BHP apply the higher standard. All projects and proposed new operations are required to submit progress reports to senior management across the project lifecycle to report on progress or any challenges to satisfying BHP’s FPIC procedures. In FY2025, we aim to continue to strengthen our internal systems for collecting and reporting on the global management of risks to Indigenous peoples and FPIC processes with Indigenous peoples.

During FY2024, we progressed work in relation to further developing how we will approach Indigenous Cultural and Intellectual Property (ICIP) and Data Sovereignty in line with the principle set out in our Indigenous Peoples Policy Statement. We plan to continue this work into FY2025, which we expect to inform the design of our standards and processes for the collection, access and reuse of cultural information that pertains to Indigenous peoples.

### BHP's Indigenous Peoples Policy Statement

BHP's ambition is to create long-term relationships with Indigenous peoples based on trust and mutual benefit. We aim to support reconciliation with Indigenous peoples and contribute to improved social, economic and environmental outcomes. Through our Policy Statement we will be guided by the aims of the United Nations Declaration on the Rights of Indigenous peoples as articulated in the Policy Statement's Principles, which are summarised below.



### Indigenous partnerships

Under the Indigenous partnerships pillar of our social value framework, we have set ourselves the goal of delivering respectful relationships that hear and act upon the distinct perspectives, aspirations and rights of Indigenous peoples and support the delivery of mutually beneficial and jointly defined outcomes (refer to OFR 6.5). We have committed to report annually on metrics for Indigenous employee representation, Indigenous procurement, our 'progress to plan' against the co-designed Indigenous Peoples Plans in each region where we operate, and about actions to improve the health of our relationships with those Indigenous peoples.

### Relationship health

In FY2024, we completed an inaugural assessment of the health of our relationships with a range of our Indigenous partners. We engaged global research firm, Ipsos, to independently gather feedback on a confidential basis from a number of BHP's Indigenous partners in Australia, Canada and Chile where we operate our assets. In total, representatives from 17 of 26 Indigenous partner organisations who were contacted to take part in the inaugural assessment agreed to participate. All organisations that were contacted for the inaugural assessment have current agreements with BHP or are located on or near our operations. The feedback indicated that relationships had been strained in the past. While BHP is making some progress in its relationships with Indigenous partners, there is still more to do to achieve our goal of delivering respectful relationships that hear and act upon the distinct perspectives, aspirations and rights of Indigenous peoples and support the delivery of mutually beneficial and jointly defined outcomes. Recommendations for improvement include more resourcing and empowerment of BHP's Indigenous Engagement teams, and greater involvement for Indigenous partners in BHP decision-making around employment, procurement and community initiatives to ensure opportunities are available to Indigenous peoples at the community level. The feedback also indicated that some Indigenous partners desire a greater level of involvement from BHP in community engagements, such as in cultural events and informal meetings. The relationship health results varied across the different countries covered in the assessment and is broadly summarised as:

**Canada:** The five Canadian Indigenous organisations that participated reported a positive trajectory in their relationship health with BHP and expressed the most optimism in their feedback on the future potential of relationships. Key personnel at BHP were seen to instigate respectful, meaningful and genuine engagements with Indigenous communities. This has helped create trust in BHP's commitment to deliver positive outcomes through community investments and initiatives. Some areas of concern included past instances of cultural disrespect and that proactive steps to understand Indigenous history and culture were not always consistently applied. In some instances, there was frustration expressed about communications and transparency, as well as present levels of Indigenous employment representation. The feedback indicates desire to see more two-way dialogue with decision-makers established. Looking to the future, Canadian Indigenous partners expressed a high degree of optimism at the economic opportunities at the Jansen operation. To maintain this optimism, partners in Canada seek increased Indigenous representation in decision-making processes and positions and expect a stronger focus on training and upskilling so that Indigenous peoples may increase their employability to work for BHP.

**Australia:** The six Australian Indigenous organisations that participated indicated there had been an improvement in relationship health from the past to the present. Many of the improvements in overall relationship health were attributed to key personnel at BHP who advocate strongly for Indigenous partners and who conduct their engagements respectfully with long-term goals of Indigenous advancement in mind. The establishment of Indigenous Engagement and Cultural Heritage teams and greater direct engagement from BHP senior leaders in Australia were seen as improvements. However, the feedback also indicates only marginal improvement from the present to the future for our relationships in Australia. Some Indigenous partners reported that relationships can still feel transactional and lacked continuity. In some instances, there was a view expressed that BHP could provide more commercial and employment opportunities to Indigenous partners and improve the accessibility of its systems and processes. These factors contributed to a less optimistic outlook about the future state of the relationship compared to the other jurisdictions. There was a desire expressed by Australian Indigenous partners to see more Indigenous peoples advancing to more senior roles in BHP. Partners also expressed a desire to see more social investment initiatives that benefit more groups. These changes, along with more frequent engagement with decision-makers, were seen as necessary steps to build trust and to help move towards more respectful relationships based on mutual benefit in the future.

**Chile:** The six Chilean Indigenous organisations that participated indicated they had seen modest improvement in relationship health from the past to the present and were more optimistic in their view on the future. Indigenous partners in Chile perceive inadequacies in the opportunities and operational and environmental protections offered by the national legal system and they expect BHP to set a higher standard. There was a perception that BHP had prioritised commercial outcomes in the past and there had, in some cases, been inadequate recognition and understanding of Chilean culture and values. Some partners continue to perceive protections as inadequate in managing environmental impacts and want to see BHP enhance cultural protections, improve access to areas that hold cultural meaning and implement measures to minimise the health impacts of mining on communities. More generally, partners expressed a desire to see BHP be more proactive in engagement with a broader range of the community, including those that are not recognised by Chilean legal structures. Partners believe employment and training opportunities could be better geared to Indigenous staff and skillsets in the community to improve levels of Indigenous employment. There appears to be an openness from Indigenous partners to continue engaging to improve relationships with BHP in Chile.

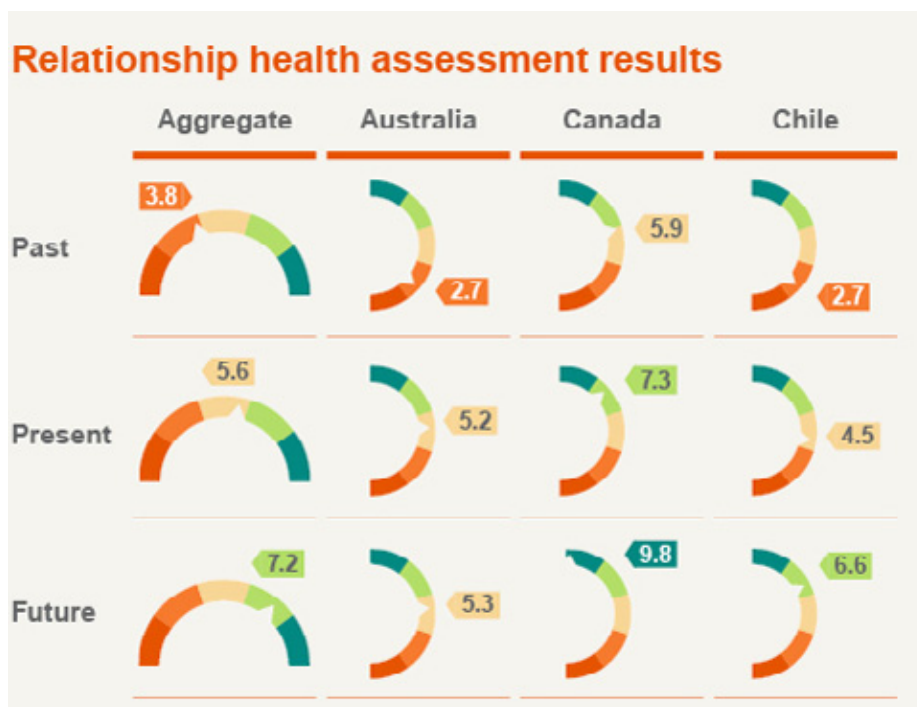

Each interview was structured around one theme: How would you rate the overall health of the organisation/entity’s relationship with BHP over three time periods in considering the past, present and future of the relationship? Responses were recorded as a rating from zero to 10. Our regional Indigenous Peoples Plans are being considered in light of the partner feedback received and to identify areas of focus within the actions set under those plans.

### Progress to plan

We are making progress with our commitments in the global Indigenous Peoples Policy Statement and the social value framework to incorporate ‘Indigenous voices and perspectives’ into co-designed priorities, as set out in the Indigenous Peoples Plans in each region where we operate.

We ‘partially met’ our FY2024 social value scorecard short-term milestone ‘Indigenous voices and perspectives are incorporated into co-designed priorities in each region’ as two out of three countries have published a co-designed regional Indigenous Peoples Plan that has incorporated the voices and perspectives of Indigenous peoples. Australia published its Reconciliation Action Plan (RAP) in FY2023. Canada approved its Canada Indigenous Partnerships Plan (CIPP) in FY2024. Chile is still developing its regional Indigenous Peoples Plan and hopes to publish it in FY2026.

**Australia:** Minerals Australia released its RAP in FY2023.<sup>1</sup> There were 25 RAP targets that were due to be achieved in FY2024; of this, 21 targets were completed in full and we also completed our reforms to embed four ongoing RAP targets into standard business requirements. RAP targets have been embedded in BHP’s business planning process and performance is measured regularly through a new RAP performance dashboard with live data and scorecards. The BHP RAP Governance and Accountability Framework has seen the development of the BHP Australian Indigenous Peoples Working Group (AIPWG) that is attended by the Minerals Australia Business President and Chief Legal, External Affairs and Governance Officer.

**Canada:** Minerals Americas approved its first Canada Indigenous Partnerships Plan (CIPP) in FY2024. The plan assists BHP to operationalise our global Indigenous Peoples Policy Statement and respond to the Truth & Reconciliation Call to Action 92 for businesses in Canada. The CIPP signifies the journey towards greater co-creation and to develop impactful partnerships, deliver on Indigenous employment and procurement targets, as well as support the wellbeing of Indigenous peoples through internal cultural awareness training and social investment activities. Implementation of the CIPP is expected to begin in Q1 of FY2025.

**Chile:** In FY2024, Minerals Americas designed the process for developing an Indigenous Peoples Plan for Chile and is expected to commence consultations with Indigenous peoples in FY2025 to start to co-design the plan. We aim to publish the plan in FY2026.

### Indigenous procurement and employee participation

We are making progress against our social value scorecard metrics for Indigenous employee participation and Indigenous procurement. Indigenous employment teams developed and implemented Indigenous workforce initiatives in FY2024 to help provide pathways to employment, support our Indigenous workforce, build a more culturally capable non-Indigenous workforce and meet our employment metrics. In Australia, our Indigenous employment was at 8.3 per cent in FY2024, down from 8.6 per cent in FY2023, and our target is to reach 9.7 per cent by FY2027. In Chile, our Indigenous employment was at 10.1 per cent in FY2024, up from 9.7 per cent in FY2023, and we surpassed our target to reach 10 per cent by FY2025. In Canada, our Indigenous employment was at 11.2 per cent in FY2024, up from 7.7 per cent in FY2023, and our target is to reach 20 per cent by FY2026.

**> For more information on our employee data and approach refer to OFR 6.6**

In FY2024, we continued to improve engagement with Indigenous businesses across all our operating locations.<sup>2</sup> Compared to FY2023, our direct global spend with Indigenous businesses increased by 83 per cent to US\$609 million in FY2024 and the number of Indigenous vendors engaged rose by 20 per cent to 263. Through this effort, we have seen continued growth in spend with Indigenous businesses across our Australian assets with FY2024 direct spend of US\$458 million up from US\$267.5 million in FY2023 in line with our Reconciliation Action Plan (RAP) commitments. In Canada, spend with Indigenous business partnerships during FY2024 totalled US \$151 million continuing the focus on these opportunities since the sanctioning of Jansen Stage 1.

#### Footnotes

1. For more information about the Australian RAP refer to [bhp.com/-/media/project/bhp1ip/bhp-com-en/documents/careers/indigenous-peoplesand-bhp/200921\\_bhpreconciliationactionplan.pdf](https://bhp.com/-/media/project/bhp1ip/bhp-com-en/documents/careers/indigenous-peoplesand-bhp/200921_bhpreconciliationactionplan.pdf).
2. For definitions for Indigenous businesses in each operating location refer to the ESG Standards and Databook 2024.

#### Minerals Australia

BHP held its second annual Traditional Owners' Forum in Brisbane in November 2023 with strong representation from Traditional Owner groups from around Australia. BHP sought input from Traditional Owners to co-create the 2023 agenda, and the themes of discussion provided an opportunity to reflect and speak honestly on BHP's performance and delivery in the context of Traditional Owner experiences.

We have undertaken consultation in FY2024 to understand the elements of an effective and sustainable model for an Indigenous advisory body in Minerals Australia, and, once developed, the advisory body will shape BHP's understanding and implementation of commitments in the RAP, until the end of FY2027.

A Cultural Heritage Standard that was developed in FY2023 by the Minerals Australia Cultural Heritage team was embedded in all BHP operated assets in Minerals Australia in FY2024. This Standard considers leading international and national frameworks and aims to enable mining activity while simultaneously encouraging the voices of relevant First Nations/Indigenous peoples to be at the forefront of decision-making processes on heritage matters through the mining lifecycle.

In FY2024, one new Heritage Agreement and 11 new Cultural Heritage Management Plans were successfully negotiated with Indigenous communities. These Cultural Heritage Management Plans mainly covered existing operations at WAIO and BMA to modernise existing government approvals. In line with our social value approach, new heritage protection areas were also agreed through the Cultural Heritage Management Plans and projects supported with communities to culturally map these places for knowledge transfer and wider community benefits.

#### Minerals Americas

##### Chile

In FY2024, Escondida developed a new Indigenous partnership strategy, which aims to build a stable, long-term relationship, based on trust and mutual benefits, with the five Indigenous communities of Borde Sur: Peine, Talabre, Socaire, Camar and Toconao. The strategy is focused on resolving past grievances, honoring commitments and creating opportunities for regular and structured dialogue between Escondida and Indigenous communities that will contribute to improved relationships, build greater trust and proactively address community concerns. In FY2024, Escondida updated its Community Relationship Strategy with the Indigenous community of Peine, which is focused on building and maintaining a long-term relationship. Meetings have been held with Peine to help inform the project of progressive closure of the Monturaqui well field.

Our Cerro Colorado operation is planning the execution of several projects for the next five to seven years, including: care and maintenance activities, closure works on the Parca Slope, geo/hydro physical drillings and the Cerro Colorado Life Extension (CCLE) project. All projects will be executed on the Cerro Colorado mine site and surrounding territories, which are on lands that are neighbouring the villages of Parca, Iquiuca, Quipisca and Mamiña, among others. These areas are under a Chilean state's special administrative regime (Área de Desarrollo Indígena) and are subject to territorial claims by different Indigenous organisations. We are engaging with Indigenous peoples to include their voices during the study phases for these projects. Despite experiencing challenges with some engagements, Cerro Colorado is working on an update of the strategy with Indigenous communities, aimed at reaching agreements with as many communities/associations as possible.

##### Canada

In FY2024, we started to operationalise two draft milestones in the Canadian Indigenous Partnership Plan (CIPP) while it was under development. The recommended review and refresh of our internal Indigenous awareness training that is delivered to all employees and contractors that work at our Jansen site is underway and will include Indigenous perspectives in the Effective Leadership training. Additionally, Human Resources conducted an external review of the human resources policies to support Indigenous inclusion. A new employee resource group for Indigenous employees located in Canada, [Indigenous@BHP](mailto:Indigenous@BHP) Canada, was created in FY2024 and has been meeting regularly to determine how best to support recruitment, retention and advancement for current and future Indigenous employees.

##### Legacy assets

BHP owns more than 20 former copper, uranium and other mine sites, called legacy assets, in the US southwest and across Canada. Many of these sites are in the traditional territories of Native American Tribes and First Nations. The legacy assets are in a state of closure or post-closure and focused on tailings and water management, risk mitigation and technical studies, closure and environmental remediation projects, and general site care and maintenance. We recognise closure is a long-term process, and that Indigenous peoples have an interest in seeing the sites returned to as close to a natural state as possible. BHP engages with Indigenous groups near our legacy assets and is in varying stages of resetting or establishing collaborative working relationships and partnerships.

##### Resolution Copper

Resolution Copper Mining is owned by Rio Tinto (55 per cent) and BHP (45 per cent), and managed by Rio Tinto. We acknowledge the Resolution Copper project area includes areas of cultural significance for Native American Tribes and their members, and is the subject of ongoing litigation. Development of the project continues to be studied and remains subject to regulatory reviews by federal, state and local governments. Resolution Copper Mining continues to cooperatively engage in these regulatory processes and has publicly stated its commitment to deepening ongoing engagement with Native American Tribes and stakeholders to understand and seek to mitigate potential adverse impacts, while also collaborating to create shared value opportunities. We are monitoring Resolution Copper Mining's engagement, FPIC and agreement-making processes.

**6.13 Independent Assurance Report to the Management and Directors of BHP Group Limited ('BHP')**

Not required for US reporting.

For personal use only



## 7 Samarco

### Fundão dam failure

As a result of the Fundão dam failure in November 2015, a significant volume of tailings (39.2 million cubic metres) resulting from the iron ore beneficiation process was released. Tragically, 19 people died as a result of the failure. The communities of Bento Rodrigues, Paracatu de Baixo and Gesteira were flooded and other communities and the environment downstream in the Doce River basin were also affected.

Samarco restarted its operations at a reduced production level in December 2020 and is currently operating at 31 per cent of its production capacity.

**>For information on Samarco's operations refer to OFR 5.3**

### Our response and support for the Foundation

Following the dam failure, BHP Brasil<sup>1</sup> has been and remains fully committed to supporting the extensive ongoing remediation and compensation efforts of Renova Foundation in Brazil. BHP Brasil's commitment to collectively seek solutions for a full, fair and definitive response remains unwavering.

In March 2016, a Framework Agreement entered into between Samarco, Vale, BHP Brasil and relevant Brazilian authorities established the Renova Foundation, a not-for-profit, private foundation responsible for implementing 42 remediation and compensatory programs. BHP Brasil, along with Samarco and Vale, provide support and funding to the Renova Foundation, including through representation in its governance structures.

As of 30 June 2024, the Renova Foundation has spent R\$37 billion (approximately US\$7.7 billion) on remediation and compensation programs, of which approximately US\$2.6 billion has been provided by BHP Brasil.

### Renova Foundation

#### Compensation and financial assistance

The Renova Foundation continues to provide compensation to people impacted by the dam failure, oversees an extensive community resettlement program and manages measures to remediate the environment affected.

Compensation and financial assistance of approximately R\$17.5 billion (approximately US\$3.5 billion)<sup>2</sup> as of 30 June has been paid to support approximately 430,000 people affected by the dam failure. This includes:

- Approximately R\$12.2 billion (approximately US\$2.5 billion)<sup>2</sup> paid to approximately 110,000 people under the court-mandated simplified indemnity system (known as the Novel system). The Novel system was designed to provide compensation for informal workers who have had difficulty proving the damages they suffered, such as cart drivers, sand miners, artisanal miners and street vendors. The court determined the closure of the Novel system for new entries in September 2023.
- Approximately 33,000 people received emergency financial assistance.
- Approximately 39,000 people received general damages (including for loss of life, injury, property damage, business impacts, loss of income and moral damages) and more than 290,000 people have been paid a total of approximately R\$305.6 million (approximately US\$69 million)<sup>2</sup> for temporary water interruption.

**>For updates on reparation progress refer to [bhp.com/what-we-do/global-locations/brazil/samarco-reparations](https://www.bhp.com/what-we-do/global-locations/brazil/samarco-reparations)**

### Resettlement

A key priority for the Renova Foundation is the resettlement of the communities of Novo Bento Rodrigues, Paracatu and Gesteira. For Novo Bento Rodrigues and Paracatu, priority efforts included construction of houses and private property, such as small businesses and churches, as well as infrastructure and public services, including roads, power, water and sewer networks, health and services centres and schools. At Gesteira, pursuant to an agreement finalised in May 2023 and ratified by the court, families and the public authorities have opted to receive compensation instead of building a new community.

As at 30 June 2024, approximately 91 per cent of resettlement cases have been completed, either via completion of construction (with families moving in or handover to families in progress) or cash payment for those families who have opted for this option instead of the other resettlement solutions offered by the Renova Foundation. More than 260 families are now living in their new homes in Novo Bento Rodrigues and Paracatu, as well as other locations.<sup>3</sup>

### Footnotes

1. BHP Billiton Brasil Ltda (BHP Brasil) and Vale S.A. (Vale) are 50:50 shareholders in Samarco Mineração S.A. (Samarco), the independent operator of Samarco.
2. USD amount is calculated based on actual transactional (historical) exchange rates related to Renova funding.
3. For those families who chose not to join the resettlement with their previous community and instead resettled elsewhere.

Novo Bento Rodrigues and Paracatu are now functioning communities. Water treatment stations, a health centre, a church, a football field, as well as multiple businesses are operating, including supermarkets, restaurants, bars, retail shops and service stations. Additionally, community-led traditional festivities, such as Carnival and other religious events, are taking place regularly in both towns.

The resettlements have involved ongoing engagement and consultation with a large number of stakeholders, including the affected community members, their technical advisers, state prosecutors, municipal leaders, regulators and other interested parties.

The new towns were designed on land chosen by the communities to be as close as possible to the previous layout, addressing the wishes and needs of the families and communities while also meeting permitting requirements. Each family receives access to an architect to design their house within size parameters, which is then finalised and built by the Renova Foundation.

Mandated COVID-19 workforce restrictions and suspensions of works on-site from 2020 to 2022, increases to the technical scope for resettlement of the communities and permitting delays have impacted the timeline for completion. Ongoing efforts to accelerate completions while maintaining the safety requirements continued throughout FY2024.

**>For updates on reparation progress refer to [bhp.com/what-we-do/global-locations/brazil/samarco-reparations](https://www.bhp.com/what-we-do/global-locations/brazil/samarco-reparations)**

### **Other socio-economic programs**

The Renova Foundation continues to implement a wide range of socio-economic programs in addition to compensation and resettlement programs. These programs cover health and infrastructure projects in the Doce River basin, promotion of economic development in the impacted communities and sewage treatment facilities to further improve the water quality in the Doce River.

Regarding infrastructure projects, the Risoleta Neves Hydroelectric Power Plant (Candonga), which was shut down after the Fundão dam failure, restarted its operations in the state of Minas Gerais in March 2023. Additionally, 18 new water pipelines have been built in the Doce River, including one to serve the population of Governador Valadares, the biggest city in the river basin, and 19 water treatment supply systems have been upgraded to provide alternative water sources.

### **Environmental remediation**

Since December 2019, the impacted riverbanks and floodplains have been vegetated, river margins stabilised and in general, water quality and sediment qualities have returned to historic levels. The Renova Foundation continues implementing long-term monitoring and compensatory initiatives.

The Brazilian Water Agency, a federal body responsible for the implementation of Brazilian water resources, has classified the water from the Doce River as Class II, which means the water can be used for human consumption after conventional treatment, the protection of aquatic habitats and primary contact recreation, such as swimming, water skiing and diving, among other things. This is supported by approximately 1.5 million pieces of data generated annually along the Doce River by the largest watercourse monitoring system in Brazil, which is led by the Renova Foundation together with six public agencies, including the National Water and Sanitation Agency. Additionally, according to information provided by municipalities and water supply institutions, since December 2015 most of the population in the Doce River basin is using and consuming the river water after conventional treatment.

To further improve water quality in the Doce River, as compensation, the Renova Foundation has made R\$840 million (approximately US\$174 million) available for sanitation projects to prevent pollution from untreated sewage, given approximately 270 million cubic metres of untreated sewage is deposited into the Doce River every year – approximately six times the volume of non-toxic tailings that was released from Fundão. Additionally, R\$1.7 billion (approximately US\$352 million) was made available for forest recovery. It is intended that in total 40,000 hectares and 5,000 springs will be fully restored in a partnership with approximately 2,000 rural properties.

A ban on fishing activities along the coast of Espírito Santo and a precautionary conservation restriction preventing fishing for native fish species in the Doce River in Minas Gerais remain in place. The Renova Foundation continues to engage with authorities with the goal of lifting the restrictions.

**>For updates on reparation progress refer to [bhp.com/what-we-do/global-locations/brazil/samarco-reparations](https://www.bhp.com/what-we-do/global-locations/brazil/samarco-reparations)**

### **Legal proceedings**

BHP Group Limited, BHP Group (UK) Ltd (formerly BHP Group Plc) and BHP Brasil are involved in legal proceedings relating to the Fundão dam failure.

BHP Brasil, Samarco, Vale and several public authorities have been engaging in negotiations to seek a definitive and substantive settlement of certain claims relating to the Fundão dam failure.

**>For information on the significant legal proceedings and settlement negotiation process involving BHP refer to Additional information 8**

## **8 How we manage risk**

Risk management helps us to protect and create value, and is central to achieving our purpose and strategic objectives. Our Risk Framework has four pillars: risk strategy, risk governance, risk process and risk intelligence.

Risks associated with the organisations, businesses or assets that we acquire are transitioned to BHP's Risk Framework as part of integration activities, which generally involves a transitional period. Risk integration of our OZ Minerals assets (excluding the OZ Minerals Brazil assets which are subject to ongoing strategic review) remains on track for completion by the end of CY2024.

### **Risk strategy**

#### **Risk classification**

We classify all risks to which BHP is exposed using our Group Risk Architecture. This is a tool designed to identify, analyse, monitor and report risk, which provides a platform to understand and manage risks. Similar risks are considered together in groups and categories. This is designed to give the Board and management visibility over the aggregate exposure to risks on a Group-wide basis and support performance monitoring and reporting against BHP's risk appetite.

## Risk appetite

BHP's Risk Appetite Statements, aligned to our Group Risk Architecture, are approved by the Board and are a foundational element of our Risk Framework. They provide guidance to management on the amount and type of risk we seek to take in pursuing our objectives.

## Key risk indicators

Key risk indicators (KRIs) are set by management to help monitor performance against our risk appetite. They also support decision-making by providing management with information about financial and non-financial risk exposure at a Group level. Each KRI has a target, or optimal level of risk we seek to take, as well as upper and lower limits. Where either limit is exceeded, management will review potential causes to understand if BHP may be taking too little or too much risk and to identify whether further action is required.

## Risk culture

Our risk management approach is underpinned by a risk culture that supports decision-making in accordance with BHP's values, objectives and risk appetite. We use a common foundation across BHP to build the tools and capabilities required to enable us to understand, monitor and manage our risk culture. These include the risk-culture assessments undertaken as part of our internal audit plan.

## Strategic business decisions

Strategic business decisions and the pursuit of our strategic objectives can inform, create or affect risks to which BHP is exposed. These risks may represent opportunities as well as threats. Our Risk Appetite Statements and KRIs assist in determining whether a proposed course of action is consistent with BHP's risk appetite.

Our focus when managing risks associated with strategic business decisions is to enable the pursuit of high-reward strategies. Therefore, as well as having controls designed to protect BHP from threats, we seek to implement controls to enable and/or enhance opportunities.

## Risk governance

### Three lines model

BHP uses the 'three lines model' to define the role of different teams across the organisation in managing risk. This approach sets clear accountabilities for risk management and provides appropriate 'checks and balances' to support us in protecting and growing value.

The first line is provided by our frontline staff, operational management and people in functional roles – anyone who makes decisions, deploys resources or contributes to an outcome is responsible for identifying and managing the associated risks.

The Risk team and other second-line teams are responsible for providing expertise, support, monitoring and challenge on risk-related matters, including by defining Group-wide minimum standards.

The third line, our Internal Audit team, is responsible for providing independent and objective assurance over the control environment (governance, risk management and internal controls) to the Board (including applicable Board Committees) and Executive Leadership Team. Additional assurance may also be provided by external providers, such as our External Auditor.

The Risk team and Internal Audit team are led by the Chief Risk and Audit Officer. This structure facilitates overall effectiveness of both teams, including through alignment of second- and third-line assurance activities across BHP, while maintaining the independence of our Internal Audit team through appropriate safeguards.

### BHP Board and Committees

The Board reviews and monitors the effectiveness of the Group's systems of financial and non-financial risk management and internal control. The broad range of skills, experience and knowledge of the Board assists in providing a diverse view on risk management. The Risk and Audit Committee (RAC) and Sustainability Committee assist the Board by reviewing and considering BHP's material risk profile (covering operational, strategic and emerging risks) on a biannual basis.

Risk management performance is monitored and reported to the RAC, as well as the Sustainability Committee for health, safety, environment and community matters, supporting the Board to challenge and hold management to account.

### For information on other Board Committee activities that support risk governance at BHP refer to Corporate Governance Statement 5

## Risk process

Our Risk Framework requires identification and management of risks (both threats and opportunities) to be embedded in business activities through the following process:

- Risk identification – threats and opportunities are identified and each is assigned an owner or accountable individual.
- Risk assessments – risks are assessed using appropriate and internationally recognised techniques to determine their potential impacts and likelihood, prioritise them and inform risk treatment options.
- Risk treatment – controls are implemented to prevent, minimise and/or mitigate threats, and enable and/or enhance opportunities.
- Monitoring and review – risks and controls are reviewed periodically and on an ad hoc basis (including where there are high-potential events or changes in the external environment) to evaluate performance.
- Communication – relevant information is recorded in our enterprise risk management system to support continuous improvement and share risk intelligence across the Group.

Our Risk Framework includes requirements and guidance on the tools and processes to manage current and emerging risks.

## Current risks

Current risks are risks that could impact BHP today or in the near future and comprise current operational risks (risks that have their origin inside BHP or occur as a result of our activities) and current strategic risks (risks that may enhance or impede the achievement of our strategic objectives).

Current risks include material and non-material risks (as defined by our Risk Framework). The materiality of a current risk is determined by estimating the maximum foreseeable loss (MFL) if that risk were to materialise. The MFL is the estimated impact to BHP in a worst-case scenario without regard to probability and assuming all controls, including insurance and hedging contracts, are ineffective.

### For more information on our risk factors refer to OFR 8.1

Our focus for current risks is to prevent their occurrence or minimise their impact should they occur, but we also consider how to maximise possible benefits that might be associated with strategic risks (as described in the Risk strategy section). Current material risks are required to be evaluated once a year at a minimum to determine whether our exposure to the risk is within our target range.

## Emerging risks

Emerging risks are newly developing or changing risks that are highly uncertain and difficult to quantify. They are generally driven by external influences and often cannot be prevented by BHP.

BHP maintains a 'watch list' of emerging themes and monitors associated signals to interpret external events and trends, providing an evolving view of the changing external environment and how it might impact our business. We use the watch list and signal monitoring to support the identification and management of emerging risks, as well as to inform and test our corporate strategy.

Once identified, our focus for emerging risks is on structured monitoring of the external environment, advocacy efforts to reduce the likelihood of the threats manifesting and identifying options to increase our resilience to these threats.

## Risk intelligence

The Risk team provides the RAC, Sustainability Committee and senior management with insights on risk management across BHP. Risk reports may include trends, aggregate exposure and performance for our most significant risks, updates on the Risk Framework and risk management priorities, an overview of (and material changes in) BHP's material risk profile and updates on emerging risk themes and signals.

We maintain a risk insights dashboard designed to provide current, data-driven and actionable risk intelligence to our people at all levels of the business to support decision-making. This tool empowers the business to manage risks more effectively, with increased accuracy and transparency.

The Board, RAC and Sustainability Committee also receive other reports to support the Board to review and monitor the effectiveness of BHP's systems of financial and non-financial risk management. Examples of these include internal audit reports, ethics and investigations reports, compliance reports and the Chief Executive Officer's report.

### For information on our risk factors refer to OFR 8.1

## 8.1 Risk factors

Our risk factors are described below and may occur as a result of our activities globally, including in connection with our operated and non-operated assets, third parties engaged by BHP or through our value chain. These risks, individually or collectively, could threaten our strategy, business model, future performance, solvency or liquidity and reputation. They could also materially and adversely affect the health and safety of our people or members of the public, the environment, the communities where we or our third-party partners and providers operate, or the interests of our partners and stakeholders, which could in each case lead to litigation, regulatory investigations or enforcement actions (including class actions or actions arising from contractual, legacy or other liabilities associated with divested assets), or a loss of partner, stakeholder and/or investor confidence. References to 'financial performance' include our financial condition and liquidity, including due to decreased profitability or increased operating costs, capital spend, remediation costs or contingent liabilities. BHP may also be exposed to risks that we currently believe to be immaterial that may materially affect our business if they occur.

### Risk factor: Operational events

Risks associated with operational events in connection with our activities globally, resulting in significant adverse impacts on our people, communities, the environment or our business.

### Why is this important to BHP?

We engage in activities that have previously caused and have the potential to further cause harm to our people and assets, communities, other stakeholders and/or the environment, including serious injuries, illness and fatalities, loss of infrastructure, amenities and livelihood, and damage to sites of cultural significance. An operational event at our operated or non-operated assets or through our value chain could also cause damage or disruptions to our assets and operations, impact our financial performance, result in litigation or class actions and cause long-term damage to our licence to operate and reputation. Potential physical climate-related impacts could increase the likelihood and/or severity of risks associated with operational events. Impacts of operational events may also be amplified if one event triggers another (for example, a geotechnical instability event that causes a failure in a nearby tailings storage facility) or if we fail to respond to any events in a way that is consistent with our corporate values and partner and stakeholder expectations.

### Examples of potential threats

- Air, land (road and rail) and marine transportation events (such as aircraft crashes or vessel collisions, groundings or hydrocarbon release) that occur while transporting people, supplies or products, including to or from exploration, operation or customer locations. These locations may be in or require travel through areas of cultural significance or remote and environmentally sensitive areas, including in Australia, South America, Asia, the United States, Canada and Sweden.

- Failure of a water or tailings storage facility, such as the tragic failure of the Fundão dam at Samarco in 2015 or a failure at one of our other facilities in Australia, Chile, Peru, the United States, Canada or Brazil.
- Unplanned fire events or explosions (on the surface or underground).
- Geotechnical instability events (such as failure of underground excavations, which may be subject to greater risk than surface mines, unexpected large wall instabilities in our open-pit mines, or potential interaction between our mining activities and community infrastructure or natural systems), including at our mines in Australia, Chile, Peru, the United States, Canada or Brazil.
- Critical infrastructure, equipment, or hazardous materials containment failures, other occupational or process safety events or workplace exposures.
- Operational events experienced by third parties, which may also result in unavailability of shared critical infrastructure (such as railway lines or ports) or transportation routes (such as the Port Hedland channel in Western Australia).
- An operational event that may adversely affect our people and assets, communities, other stakeholders and/or the environment, including serious injuries, illness and fatalities, loss of infrastructure and damage to sites of cultural significance.
- Our operations, workforce, communities, supply chains, customers and third-party partners and providers may be increasingly exposed to changes in the frequency, intensity and/or duration of intense storms, drought, flooding, wildfire and other extreme weather or weather-related events and patterns (such as extreme heat).

#### **Risk factor: Significant social or environmental impacts**

Risks associated with significant impacts of our operations on and contributions to communities and environments throughout the life cycle of our assets and across our value chain.

#### **Why is this important to BHP?**

The long-term viability of our business is closely connected to the wellbeing of the communities and environments where we have a presence and our business is subject to increasing, complex and changing regulatory and stakeholder expectations. At any stage of the asset life cycle, our activities and operations may have or be perceived to have significant adverse impacts on communities and environments. In these circumstances, we may fail to meet the evolving expectations of our partners and stakeholders (including investors, governments, employees, suppliers, customers and Indigenous peoples and other community members) whose support is needed to realise our strategy and purpose. This could lead to loss of partner or stakeholder support or regulatory approvals, increased taxes and regulation, enforcement action, litigation (including class actions), or otherwise impact our licence to operate and adversely affect our reputation, ability to attract and retain talent, ability to access capital, operational continuity and financial performance.

#### **Examples of potential threats**

- Engaging in or being associated with activities (including through non-operated joint ventures and our value chain) that have or are perceived to have individual or cumulative adverse impacts on nature (including biodiversity, land, waters and air), climate change, supply chain or responsible sourcing requirements, human rights or Indigenous peoples' rights or cultural heritage.
- Failing to meet evolving partner or stakeholder expectations in connection with our alignment with global frameworks and societal goals, our strategic decisions, legal and regulatory obligations, acceptability of mining activities, relationships with Indigenous peoples, community wellbeing and the way we invest in communities or our approach to nature (including biodiversity, land, waters and air), climate change, supply chain or responsible sourcing requirements, human rights, Indigenous peoples' rights or cultural heritage priorities.
- Political, regulatory and judicial developments (such as legislation to enact policy positions on climate change, nature-related risk or human rights) could increase uncertainty in relation to our operating environment, and/or require us to adjust our business plans or strategy. For example, changes to regulations may require us to modify mine plans, limit our access to reserves and resources, alter the timing or increase costs associated with exploration and development of and production from, or closure and rehabilitation of, our assets, increase sourcing costs or expose BHP to unanticipated environmental or other legacy liabilities.
- Failing to adequately identify or to appropriately manage physical climate-related risks and/or nature-related risks to biodiversity and ecosystems. For example, loss of important biodiversity and/or ecosystems as a result of operational activities (e.g. unauthorised clearing of vegetation) could result in land access restrictions, a decrease in demand for our products or limit our access to new opportunities.

#### **Risk factor: Optimising growth and portfolio returns**

Risks associated with our ability to position our asset portfolio to generate returns and value for shareholders, including through acquisitions, mergers and divestments.

#### **Why is this important to BHP?**

We make decisions and take actions in pursuit of our strategy to optimise our asset portfolio and to secure and create growth options in future-facing commodities (such as copper, nickel and potash). These may include active portfolio changes such as the recent sale of the Daunia and Blackwater mines in Queensland, the acquisition of OZ Minerals and, if completed, the proposed acquisition of Filo Corp and agreement to form a joint venture with Lundin Mining. These may also include supporting innovative early-stage mineral exploration companies (including for example through our accelerator program, BHP Xplor), and maturing and developing organic growth options across our existing portfolio. A strategy that does not support BHP's objectives and/or ill-timed execution of our strategy, or other circumstances, may lead to a loss of value that impacts our ability to deliver returns to shareholders and fund our investment and growth opportunities. It may also result in our asset portfolio being less resilient to climate-related risks or movements in commodity prices, or inflationary pressures and other macroeconomic factors. In the short term, adverse movements in commodity prices may reduce our cash flow, ability to access capital or pay dividends. A failure to optimise our asset portfolio for structural movements in commodity prices (including those arising from climate-related risks) over the long term may result in asset impairments and could adversely affect the results of our operations, financial performance and returns to investors.

### Examples of potential threats

- Commodity prices have historically been and may continue to be subject to significant volatility, including due to global economic and geopolitical factors, industrial activity, commodity supply (including the development of new resources and supply chain disruptions) and demand (including inventory levels), technological change, product substitution, tariffs, interest rate movements and exchange rate fluctuations. Our usual policy and practice is to sell our products at prevailing market prices and, as such, movements in commodity prices may affect our financial performance. Long-term price volatility, sustained low prices or increases in costs may adversely impact our financial performance as we do not generally have the ability to offset costs through price increases.
- Failure to optimise our portfolio through effective and efficient acquisitions, exploration, large project delivery, mergers, divestments or expansion of existing or acquired assets (including due to sub-optimal capital prioritisation) may adversely impact our performance and/or returns to investors.
- Failure to identify potential changes in commodity attractiveness and missed entry or commodity exit opportunities may result in decreased return on capital spend for, or overpayment to acquire or invest in, new assets or projects, stranded assets or reduced divestment proceeds.
- Failure to achieve expected commercial objectives from assets or investments, such as cost savings, increased revenues or improved operational performance (including as a result of inaccurate commodity price assumptions or resources and reserves estimates), may result in returns that are lower than anticipated and loss of value. This could be exacerbated by impacts from factors such as climate-related risks, supply chain disruptions (for example, disruption in the energy sector impacting our end-user markets), labour shortages, inflationary pressures and unfavourable exchange rates, creating operational headwinds and challenging on-time and on-budget project delivery.
- Renegotiation or nullification of permits, inability to secure new permits or approvals, increased royalties, such as the Queensland Government's increase in coal royalty tax in June 2022, fiscal or monetary policy instability or changes may increase our costs or adversely impact our ability to achieve expected commercial objectives from assets or investments, access reserves, develop, maintain or operate our assets, enter new jurisdictions, or otherwise optimise our portfolio.
- Inability to predict long-term trends in the supply, demand and price of commodities and optimise our asset portfolio accordingly may restrict our ability to generate long-term returns from the portfolio. For example, slowing economic growth in China, political and trade tensions, market volatility or the global transition to a low-carbon economy may result in lower demand and prices for some of our products, which may in turn adversely impact our portfolio returns.
- Partnering with companies for growth may also damage our reputation and lead to increased potential for litigation if those companies or associated activities are misaligned with our values, standards or stakeholder expectations, particularly in circumstances in which we do not operate the asset or have a controlling interest in the venture.

### Risk factor: Low-carbon transition

Risks associated with the transition to a low-carbon economy.

### Why is this important to BHP?

- Transition risks arise from existing and emerging policy, regulatory, legal, technological, market and other societal responses to the challenges posed by climate change and the transition to a low-carbon economy. As a world-leading resources company, BHP is exposed to a range of transition risks that could affect the execution of our strategy or our operational efficiency, asset values and growth options, resulting in a material adverse impact on our financial performance, share price or reputation, including increased potential for litigation. The complex and pervasive nature of climate change means transition risks are interconnected with and may amplify our other risk factors. Additionally, the inherent uncertainty of potential societal responses to climate change may create a systemic risk to the global economy and our business.

### Examples of potential threats

- Introduction or improvement of low-carbon technologies or changes in customer preference for products that support the transition to a low-carbon economy may decrease demand for some of our products, increase our costs or decrease the availability of key inputs to production. For example:
  - Rapid shift to alternative steelmaking technology pathways (including electric arc furnace (EAF) and direct reduced iron (DRI) steelmaking) may reduce anticipated demand for our steelmaking coal and may result in the early closure or divestment of our steelmaking coal mines.
  - Increased recovery and reuse rates of commodities may reduce demand for our products.
  - New battery technologies that use no or less nickel could enter the market and reduce demand for our nickel products.
- Adverse macroeconomic changes, such as a decline in global economic activity and/or security, could be exacerbated by the transition to a low-carbon economy and reduce anticipated demand for our future-facing commodities, such as copper and nickel.
- Perceptions of climate-related financial risk and/or social concerns around climate change may result in investors divesting our securities or changing their expectations or requirements for investment in our securities, cause financial institutions not to provide financing or other products (such as insurance cover) to BHP or to our suppliers or customers, affect our suppliers' willingness to provide goods or services, and affect our customers' wish to procure our commodities. In turn, these factors could increase our costs and adversely impact our ability to optimise our portfolio and pursue growth opportunities.
- Perceived or actual misalignment of BHP's climate actions (goals, targets and performance) with societal and investor expectations, or a failure to deliver our climate actions, may result in damage to our reputation, reduced investor confidence, climate-related litigation (including class actions) or give rise to other adverse regulatory, legal or market responses.

- Sub-optimal selection, quality, implementation or effectiveness of technology and related low-carbon supplies that are intended to contribute towards the delivery of our climate targets, goals and strategies, or unavailability of that technology and related low-carbon supplies (including due to the failure of trials of new technology, a failure of external equipment manufacturers or suppliers to deliver on schedule or competition for limited supply) could prevent, limit, delay or increase costs in achieving our plans for operational decarbonisation.
- Changes or ambiguity in laws, regulations, policies, obligations, government actions and our ability to anticipate and respond to such changes or accurately interpret the ambiguity, including GHG emission targets and schemes, restrictive licensing, carbon taxes, carbon offsetting regulations, border adjustments or the addition or removal of subsidies, may give rise to adverse regulatory, legal or market responses. For example, the implementation of regulations intended to reduce GHG emissions in the steel industry in China could adversely impact demand for our steelmaking coal or iron ore. In addition, inadequate market supply of credible carbon credits or price volatility in carbon markets could increase our operating costs or result in adverse social value or compliance implications. Inconsistent or developing regulatory regimes globally may increase the likelihood of an inadvertent failure to or inability to comply with some regulations and exacerbate the impacts of transition risks.

**Risk factor: Accessing key markets**

Risks associated with market concentration and our ability to sell and deliver products into existing and future key markets, impacting our economic efficiency.

**Why is this important to BHP?**

We rely on the sale and delivery of the commodities we produce to customers around the world. Changes to laws, international trade arrangements, contractual terms or other requirements and/or geopolitical developments could result in physical, logistical or other disruptions to our operations in or the sale or delivery of our commodities to key markets. These disruptions could affect sales volumes or prices obtained for our products, adversely impacting our financial performance, results of operations and growth prospects.

**Examples of potential threats**

- Government actions, including economic sanctions, tariffs or other trade restrictions, imposed by or on countries where we operate or into which we sell or deliver our products may prevent BHP from selling or make it more difficult for BHP to sell in key markets.
- Physical disruptions to the delivery of our products to customers in key markets, including due to the disruption of shipping routes, closure or blockage of ports or land logistics (road or rail), armed conflict or criminality and organised crime. In some cases, physical disruptions may be driven or intensified by weather and climate variability, including as potentially exacerbated or affected by climate change. Our operations are located in remote and environmentally sensitive areas, which may be particularly exposed to climate-related disruptions.
- Legal or regulatory changes (such as new or increased royalties or taxes; government-mandated price caps; port, export or import restrictions or customs requirements; shipping/maritime regulatory changes; restrictions on movements or imposition of quarantines; or changing environmental restrictions or regulations, including measures with respect to carbon-intensive industries or imports) and commercial changes (such as changes to the standards, preferences and requirements of customers) may adversely impact our ability to sell, deliver or realise full market value for our products.
- Failure to maintain strong relationships with customers or changes to customer demands for our products may reduce our market share or adversely impact our financial performance.
- Increasing geopolitical tensions (including the Russia-Ukraine and Middle Eastern conflicts) may adversely affect our strategic and business planning decisions and/or increase the time it takes us to manage our access to key markets, particularly if we fail to detect or anticipate deviations in the geopolitical environment in a timely manner.

**Risk factor: Adopting technologies and maintaining digital security**

Risks associated with adopting and implementing new technologies, and maintaining the effectiveness of our existing digital landscape (including cyber defences) across our value chain.

**Why is this important to BHP?**

Our business and operational processes are increasingly dependent on the effective application and adoption of technology, which we use as a lever to deliver on our current and future operational, financial and social objectives. This exposes BHP to risks originating from adopting or implementing new technologies, or failing to take appropriate action to position BHP for the digital future, which may impact the capabilities we require, the effectiveness and efficiency of our operations and our ability to compete effectively. New technology adopted in our business may not perform as anticipated and may result in unintended impacts on our operations. We may also fail to maintain the effectiveness of our existing and future digital landscape, including cyber defences, exposing us to technology availability, reliability and cybersecurity risks. These could lead to operational events, commercial disruption (such as an inability to process or ship our products), corruption or loss of system data, misappropriation or loss of funds, unintended loss or disclosure of commercial or personal information, enforcement action or litigation, which could also impact the environment and partners, suppliers and stakeholders across our value chain. Additionally, an inability to adequately maintain existing technology or implement critical new technology, or any sustained disruption to our existing technology may adversely affect our licence to operate, reputation, results of operations and financial performance.

**Examples of potential threats**

- Cybersecurity events or attacks on our information or operational technology systems, including on third-party partners and providers (such as our cloud service providers), may result in a failure of business-critical technology systems at one or more of our assets, which may reduce operational productivity, result in environmental damage, fines, penalties, litigation, regulatory or governmental investigations, workforce disruption, prolonged negative media attention and/or adversely impact safety and financial performance. We have experienced cybersecurity threats in the past and may experience them in the future and, as our dependence on information systems, including those of our third-party partners and providers, grows, we may become more vulnerable to an increasing threat of continually evolving cybersecurity risks.

- Failure to invest in appropriate technologies or to keep pace with advancements in technology that support the pursuit of our objectives may adversely impact the effectiveness or efficiency of our business and erode our competitive advantage. For example, a failure to implement appropriate technologies that support our assets to produce higher-grade commodities or less waste from existing resources (such as ongoing initiatives to incorporate new technologies and data analytics to leaching processes) could limit our ability to sell our commodities or reduce costs.
- Failure to identify, access and secure necessary infrastructure and key inputs (including electricity, internet bandwidth, data, software, licences or other rights in intellectual property, hardware and talent) to support new technology innovations and advanced technologies may adversely affect our ability to adopt, operate or retain access to those technologies. This includes Artificial Intelligence (AI) and machine learning, process automation, robotics, data analytics, cloud computing, smart devices and remote working solutions. For example, adopting new technology to reduce GHG emissions using alternative energy sources may require new infrastructure, while effective implementation of new digital technologies (such as machine learning) may be heavily dependent on access to data. In addition, the use of AI and machine learning may increase our exposure to cybersecurity risks and additional risks relating to the protection of data, including increased exposure of confidential or otherwise protected information to unauthorised recipients, which could result in liability under or termination of our contracts with third parties, misuse of our intellectual property or other unintended consequences.
- Failure to adopt or successfully integrate new technology, technology enhancements or technology acquired through inorganic growth (such as through acquisition of a company with different types and standards of securities, technologies and systems) may result in impacts to our business and operations. This could lead to operational stoppage events, commercial disruption (such as an inability to pay or accept payment), inability to disclose accurately or an inability to adequately maintain existing technology.
- Failure or outage of our information or operational technology systems.

#### **Risk factor: Ethical misconduct**

Risks associated with actual or alleged deviation from societal or business expectations of ethical behaviour (including breaches of laws or regulations) and wider or cumulative organisational cultural failings, resulting in significant reputational impacts.

#### **Why is this important to BHP?**

Actual or alleged conduct of BHP or our people or third-party partners and providers that deviates from the standard of ethical behaviour required or expected of us could result in reputational damage or a breach of law or regulations. Such conduct includes fraud, corruption, anti-competitive behaviour, money laundering, breaching trade or financial sanctions, market manipulation, privacy breaches, ethical misconduct, failure to comply with regulatory requirements and wider organisational cultural failings. A failure to act ethically or legally may result in negative publicity, investigations, public inquiries, regulatory enforcement action, litigation or other civil or criminal proceedings, other forms of compensation or remediation, or increased regulation. It could also threaten the validity of our tenements or permits, or adversely impact our reputation, results of operations, financial performance or share price. Impacts may be amplified if our senior leaders fail to uphold BHP's values or address actual or alleged misconduct in a way that is consistent with societal, partner and stakeholder expectations. Our workplace culture may also be eroded, adversely affecting our ability to attract and retain talent. Risks and impacts are also heightened by the complex and continuously evolving legal and regulatory frameworks that apply to the jurisdictions where we operate and potentially conflicting obligations under different national laws.

#### **Examples of potential threats**

- Failing to prevent breaches of international standards, laws, regulations or other legal, regulatory, ethical, environmental, governance or compliance obligations, such as external misstatements, inaccurate financial or operational reporting or a breach of our continuous disclosure obligations.
- Corruption (for example, in connection with the acquisition of early-stage options in a country with weaker governance standards), market misconduct or anti-competitive behaviour, including in relation to our joint venture operations.
- Failing to comply with trade or financial sanctions (which are complex and subject to rapid change and may potentially result in conflicting obligations), health, safety and environmental laws and regulations, native title and other land rights or tax or royalty obligations.
- Failing to protect our people from harm (including to mental and physical health) due to misconduct that takes place in connection with their work, such as discrimination or sexual harassment.
- Failing to uphold BHP's values or address actual or alleged misconduct may adversely impact workplace culture and may expose BHP to regulatory action or litigation, adversely impacting our reputation and ability to attract and retain talent.

#### **Risk factor: Inadequate business resilience**

Risks associated with unanticipated or unforeseeable adverse events and a failure of planning and preparedness to respond to, manage and recover from adverse events (including potential physical climate-related impacts).

#### **Why is this important to BHP?**

In addition to the threats described in our other risk factors, our business could experience unanticipated, unforeseeable or other adverse events (internal or external) that could harm our people, disrupt our operations or value chain or damage our assets or corporate offices, including our non-operated assets in which BHP has a non-controlling interest. A failure to identify or understand exposure, adequately prepare for these events (including maintaining business continuity plans) or build wider organisational resilience may inhibit our (or our third-party partners and providers') ability to respond and recover in an effective and efficient manner. This includes a failure to build resilience to physical climate-related risks. Material adverse impacts on our business include reduced ability to access resources, markets and the operational or other inputs required by our business, reduced production or sales of or demand for, our commodities, or increased regulation, which could adversely impact our financial performance, share price or reputation and could lead to litigation (including class actions).



## Examples of potential threats

- Geopolitical, global economic, regional or local developments or adverse events, such as social unrest, strikes, work stoppages, labour disruptions, social activism, terrorism, bomb threats, economic slowdown, acts of war or other significant disruptions in areas where we operate or have interests.
- Extreme weather and climate-related events, such as heatwaves, extreme precipitation and flooding, hurricanes, cyclones and fires. For example, production at our steelmaking coal asset, BMA, was partly impacted in H1 FY2024 due to depleted inventory positions that arose from extended weather impacts on the east coast of Australia.
- Other natural events, including earthquakes, tsunamis, wildfires, solar flares and pandemics.
- Potential physical climate-related impacts, such as acute risks that are event driven (including increased frequency and severity of extreme weather events) and chronic risks resulting from longer-term changes in climate patterns. Climate hazards may include changes in precipitation patterns, water shortages, rising sea levels, increased storm intensity, prolonged extreme temperatures and increased drought, fire and flooding.
- Failure by suppliers, contractors or joint venture partners to perform existing contracts or obligations (including due to insolvency), such as construction of large projects or supply of key inputs to our business (for example, consumables for our mining equipment).
- Failure of our risk management or other processes (including controls) to prepare for or manage any of the risks discussed in this Risk factors section may inhibit our (or our third-party partners and providers') ability to manage any resulting adverse events and may disrupt our operations or adversely impact our financial performance or reputation. This includes unknown pre-existing failures in organisations, businesses or assets that we acquire through non-organic growth, as well as any failures that occur during their integration to our business (for example, due to different standards or systems).

## 8.2 Management of risks

Each risk factor may present opportunities as well as threats. We take certain risks for strategic reward in the pursuit of our strategy and purpose, including to grow our asset portfolio and develop the right capabilities for the future of our business. Some of the potential threats and opportunities associated with each of our risk factors are described below, along with the key controls to manage them. These controls are not exhaustive and many Group-wide controls (such as *Our Code of Conduct*, Risk Framework, mandatory minimum performance requirements for risk management, health, safety and other matters, dedicated non-operated joint venture teams and our Contractor Management Framework) help to support effective and efficient management of all risks in line with our risk appetite. While we implement preventative and/or mitigating controls designed to reduce the likelihood of a threat from occurring and minimise the impacts if it does, these may not always be effective.

### Risk factor: Operational events

#### Examples of potential opportunities

- Our commitment to our communities, the environment and the safety and wellbeing of our people may increase operational resilience as well as partner and stakeholder confidence, enhancing our ability to attract and retain talent and access (or lower the cost of) capital.
- Collaborating with industry peers and relevant organisations on minimum standards (such as the internationally recognised Flight Safety Foundation's Basic Aviation Risk Standard, Global Industry Standard on Tailings Management, Large Open Pit Project guidelines on open-pit mining design and management, and the Cave Mining 2040 Consortium on deep mining design and management) supports improvements to wider industry management of operational risks and may also identify opportunities to improve our own practices.

#### Key management actions

- Planning, designing, constructing, operating, maintaining and monitoring surface and underground mines, water and tailings storage facilities, and other infrastructure and equipment in a manner designed to maintain structural integrity, prevent incidents and protect our people, assets, communities, the environment and other stakeholders.
- Specifying minimum requirements and technical specifications, such as for transportation (including high-occupancy vehicles, fixed and rotary wing aircraft and their operators) and geotechnical (including characterisation, design, ground control and monitoring), and focusing on compliance with operating specifications, industry codes and other relevant standards, including BHP's mandatory minimum performance requirements.
- Continuing to focus on improving our management of safety risks, including through investigation and response to the recent fatal incidents across our operations, and through programs such as the Fatality Elimination and Field Leadership Programs.
- Defining key governance roles, such as a dam owner (an internal BHP individual who is accountable for maintaining effective governance and integrity of each tailings storage facility) and providing training and qualifications for our people.
- Inspections, technical reviews, audits and other assurance activities, such as independent dam safety reviews and geotechnical review boards.
- Maintaining evacuation routes, supporting equipment, crisis and emergency response plans and business continuity plans.
- Incorporating future climate projections into risks associated with operational events through ongoing assessment of physical climate-related risks.

## FY2024 insights

Our exposure to risks associated with operational events remained broadly stable in FY2024. BHP achieved conformance to the Global Industry Standard on Tailings Management for 'Very High' and 'Extreme' rated facilities in H1 FY2024, supporting our continued focus to further improve the safety and integrity of all facilities across our operated and closed assets.

### For more information refer to

- OFR 6.1 – Safety
- OFR 6.4 – Material topics for sustainability reporting
- OFR 6.6 – People
- OFR 6.7 – Health
- OFR 6.9 – Climate change
- OFR 6.10 – Environment and nature
- OFR 6.11 – Community
- OFR 6.12 – Indigenous peoples
- OFR 7 – Samarco
- [bhp.com/sustainability](https://bhp.com/sustainability)

### Risk factor: Significant social or environmental impacts

#### Examples of potential opportunities

- Our support for responsible stewardship of natural resources may enhance the resilience of the environments and communities where we operate to threats (including potential physical climate-related impacts and nature loss).
- Strong social performance, including sustainable mining and a focus on the wellbeing of communities, could generate competitive advantage in the jurisdictions where we operate.
- Our global social value framework and projects funded through social investment may improve partner and stakeholder relations, enhance community trust and increase investor confidence and demand for our commodities.
- Greater clarity, transparency and standards associated with regulatory regimes that support and protect communities and the environment may increase requirements across our sector, generating competitive advantage for companies that have already invested in social and environmental performance.

#### Key management actions

- The *Community Global Standard*, the *Environment Global Standard*, the *Climate Change Global Standard* and our mandatory minimum performance requirements for water, closure and legacy management, and social value and sustainability are designed to set out our targets, goals, commitments and/or approach to these matters, strengthening our social, human rights and environmental performance.
- Engaging in regular, open and transparent dialogue with partners and stakeholders to better understand their expectations, concerns and interests, undertaking research to better understand partner and stakeholder perceptions, and taking those considerations into account in planning and execution activities.
- Continuing to operationalise our Indigenous Peoples Policy Statement, including by introducing procedures for projects and assets to identify and assess potential adverse impacts to Indigenous peoples, and to engage and consult with them to better understand how we can avoid, mitigate and/or substantially address any adverse impacts.
- Building social value into our decision-making process, along with financial considerations, including through our social value framework and 2030 goals.
- Building partner and stakeholder trust and contributing to environmental and community resilience, including through collaborating on shared challenges (such as climate change and nature), enhanced external reporting of our operated assets' potential impacts on nature, and maximising the value of social investments (including contributing to climate-related initiatives) through our social investment strategy.
- Conducting regular research and impact assessments for operated assets to better understand the social, environmental, human rights and economic context. This supports us to identify and analyse potential partner, stakeholder, community and human rights impacts, including modern slavery risks and emerging issues. We also complete risk-based due diligence screening on suppliers through our Ethical Supply Chain and Transparency program.
- Integrating closure into our planning, decision-making and other activities through the life cycle of our operated assets, as set out in our mandatory minimum performance requirements for closure and legacy management.

## FY2024 insights

Our exposure to risks with potentially significant social or environmental impacts steadily increased in FY2024 due to greater external stakeholder expectations for corporate social and environmental performance, including aspects of climate change and nature. The intersections between climate change, nature, Indigenous peoples and human rights are becoming more widely understood by civil society, contributing to an evolving and increasingly complex risk landscape. To support effective management of these risks, we continue to monitor and seek to better understand the intersecting risk landscape and integrate controls into our management systems.

**For more information refer to**

- OFR 6.5 – 2030 goals
- OFR 6.6 – People
- OFR 6.9 – Climate change
- OFR 6.10 – Environment and nature
- OFR 6.11 – Community
- OFR 6.12 – Indigenous peoples
- [bhp.com/sustainability](https://www.bhp.com/sustainability)

**Risk factor: Optimising growth and portfolio returns****Examples of potential opportunities**

- Acquisition of new resources or acceleration of organic growth options in future-facing commodities may strengthen and diversify our portfolio and protect and grow value over the long term.
- Ability to predict long-term commodity demand, supply and price trends may lead to BHP being able to identify and acquire new future-facing commodities and assets ahead of our competitors or exit from declining commodities in a timely manner, strengthening our portfolio and leading to long-term, higher portfolio returns.
- BHP may be perceived as a welcome and valued or preferred partner for the development of new resource opportunities, enabling us to secure new assets or exploration opportunities to create long-term optionality in the portfolio.

**Key management actions**

- Further developing strategies, processes and frameworks to grow and protect our portfolio and to assist in delivering ongoing returns to shareholders, including:
  - our Capital Allocation Framework, corporate planning processes and investment management processes
  - annual reviews (including resilience testing) of portfolio valuations
  - our exploration, ventures (such as BHP Ventures), accelerators (such as BHP Xplor) and business development programs, which focus on replenishing our resource base and enhancing our portfolio (including creating and securing more options in future-facing commodities)
  - our long-term strategic outlook and ongoing strategic processes to assess our competitive advantage and enable the identification of threats to or opportunities for our portfolio through forecasting and scenario modelling
  - monitoring signals to interpret external events and trends, and designing commodity strategies and price protocols that are reviewed by management and the Board
  - our balance sheet and liquidity framework, which is designed to maintain a robust balance sheet with sufficient liquidity and access to diverse sources of funding, to enable us to be ready to pursue growth opportunities as and when they arise
- Pursuing a considered approach to new country entry, including further building our capability to operate in higher-risk jurisdictions, in order to support portfolio opportunities.
- Further developing BHP's social value proposition to position BHP as a preferred partner for the development of resource opportunities in line with the expectations of local communities, host governments and other global stakeholders.

**FY2024 insights**

Our exposure to risks associated with optimising growth and portfolio returns remained stable in FY2024 as we continued to implement a growth agenda focused on aligning the portfolio towards future-facing commodities. In particular, in FY2024 we completed the sale of the Daunia and Blackwater mines in Queensland to Whitehaven Coal, approved an investment in stage two of the Jansen potash project in Canada, and continued to pursue options to build our portfolio in future-facing commodities. We also made the decision to temporarily suspend Western Australia Nickel as a result of oversupply in the global nickel market. Forecast nickel prices for the next half of the decade have fallen sharply due to strong growth in alternative, low-cost nickel supply.

**For more information refer to**

- OFR 3 – Positioning for growth
- OFR 9 – Performance by commodity

## **Risk factor: Low-carbon transition**

### **Examples of potential opportunities**

- Our copper, nickel, iron ore, steelmaking coal and uranium provide essential building blocks for existing and new renewable energy infrastructure and alternative power generation and electric vehicles, and can play an important part in the transition to a low-carbon economy.
- Our potash fertiliser options, once operational, have the potential to promote more efficient and profitable agriculture and help alleviate the increased competition for arable land, including due to implementation of nature-based solutions to help address climate change and global population growth.
- Increased collaboration with customers, suppliers and original equipment manufacturers, such as BHP's partnerships with ArcelorMittal, BlueScope, China Baowu, HBIS Group, JFE, POSCO and Tata Steel to explore technologies to reduce GHG emissions across the steel value chain, can provide opportunities for the development of new products and markets.

### **Key management actions**

- Establishing public positions on, and mandatory minimum performance requirements for, managing climate change risks (threats and opportunities), which are set out in our Climate Change Report 2020, our Climate Transition Action Plan 2024 and the *Environment Global Standard* and the *Climate Change Global Standard*.
- Using climate-related scenarios, as well as our planning cases and other themes and signposts (such as monitoring policy, regulatory, legal, technological, market and other societal developments) to evaluate the resilience of our portfolio, allocate capital and inform our strategy.
- Considering transition risks (including carbon prices) when making capital expenditure decisions or allocating capital through our Capital Allocation Framework, supporting the prioritisation of capital and investment approval processes.
- Seeking to mitigate our exposure to risks arising from policy and regulation in our operating jurisdictions and markets by reducing our operational GHG emissions and supporting GHG emission reductions in our value chain.
- Informing investors on progress to date and plans for achieving our operational and value chain GHG emissions goals and targets, for example, through investor briefings and publications, including our Climate Transition Action Plan 2024.
- Advocating for the introduction of an effective, internationally aligned long-term policy framework that can deliver a measured transition to a low-carbon economy.

### **FY2024 insights**

Our exposure to transition risks increased during FY2024 due to continued societal expectations for accelerated decarbonisation by companies, significant regulatory developments across the globe (such as the enhanced Safeguard Mechanism enacted into law in Australia) and commitment by 130 countries at the 2023 United Nations Climate Change Conference to triple global renewable energy generation capacity by 2030. Many jurisdictions (including Australia) have implemented, are in the process of designing, or are considering, mandatory climate-related financial reporting regimes (including the introduction of the Climate-related financial disclosures Bill into the Australian Parliament) and – in some cases – broader sustainability reporting requirements. This includes the EU's Corporate Sustainability Reporting Directive (CSRD), and a growing number of jurisdictions have announced an intention to adopt the IFRS Sustainability Disclosure Standards developed by the International Sustainability Standards Board (ISSB). There are also increased efforts by some governments to fund expansion of renewable energy generation and technologies that help enable the energy transition, which may increase the scale and pace of the low-carbon transition, and influence the availability of lower GHG emissions technology options for BHP. These external developments present both threats and opportunities for BHP as we continue to increase our portfolio exposure to future-facing commodities.

### **For more information refer to**

- BHP Climate Change Report 2020
- BHP Climate Transition Action Plan 2024
- OFR 3 – Positioning for growth
- OFR 6.5 – 2030 goals
- OFR 6.9 – Climate change
- OFR 6.10 – Environment and nature
- [bhp.com/sustainability/climate-change](https://bhp.com/sustainability/climate-change)

## **Risk factor: Accessing key markets**

### **Examples of potential opportunities**

- Monitoring macroeconomic, societal, geopolitical and policy developments and trends may reveal new markets or commodities, identify opportunities to strengthen secondary markets for existing products or identify a potential competitive advantage or price premium for existing products.
- Developing strategic partnerships and strong, mutually beneficial relationships with our customers may enable us to create value.
- Building a deep understanding of geopolitical threats and opportunities and their potential impacts on global trade flows and our business could enhance our strategy, business planning and response, providing a potential future competitive advantage.
- Identifying the potential for weather and climate variability, including as potentially exacerbated or affected by climate change, to disrupt delivery of products and implementing management measures, may increase the resilience of our operations and value chain.

- Monitoring signals and building relationships with and understanding the perspectives of influential partners and stakeholders may improve our ability to understand and provide input to policy development, and to respond to and manage any impacts from policy changes (such as trade policies).

#### Key management actions

- Monitoring and assessing our ability to access key markets, and maintaining sales plans, product placement and business resilience strategies and relationships with relevant partners and stakeholders.
- Maintaining response plans for various scenarios (including physical disruptions of logistics) to mitigate disruptions to our ability to access key markets.
- Monitoring geopolitical and macroeconomic developments and trends, including through signal monitoring and our enterprise-level watch list of emerging themes, to provide an early indication of events that could impact our ability to access or offer opportunities in relation to key markets.
- Identifying weather and/or climate-related vulnerabilities and implementing controls to mitigate disruptions to our ability to physically access key markets.
- Diversifying our asset and commodity portfolio, such as our ongoing investment in potash through the Jansen potash project, to reduce exposure to market concentration risks.

#### FY2024 insights

Exposure to risks associated with access to key markets remained broadly stable in FY2024. We continue to observe global armed conflict, political tensions, ineffective law enforcement and governance, resource and economic nationalism, social instability, and environmental deterioration. Although we have limited influence over changes in our external environment, we continue to focus on management of these risks, including through diversifying our portfolio to reduce exposure to market concentration risk.

#### Risk factor: Adopting technologies and maintaining digital security

##### Examples of potential opportunities

- Applying digital solutions across our operations may unlock greater productivity and safety performance. For example, using predictive analytics to enable operations to identify asset condition and efficiencies may improve safety, production and equipment availability, and reduce maintenance and other costs.
- Technology solutions to reduce GHG emissions may support BHP, our suppliers and customers in achieving climate action targets and goals. For example, BHP signed an agreement in December 2023 with HBIS Group trialling alternative steelmaking technology pathways including direct reduced iron production designed to lower blast furnace carbon emissions, with the aim of supporting the global energy transition.
- Developing AI in a safe and responsible manner in exploration, mine planning, remote operation and advanced robotic technologies may identify or provide access to previously unknown or inaccessible deposits and development of end-to-end autonomous mining systems.
- Using digital simulations and predictive trend modelling may enable us to optimise the deployment of new technologies, such as automation and electrification, support early identification of process variances and faults, and support the marketing of our products to customers.

#### Key management actions

- Employing a number of measures designed to protect against, detect and respond to cyber threats, events or attacks, including BHP's mandatory minimum performance requirements for technology and cybersecurity, cybersecurity performance requirements for suppliers, cybersecurity resilience programs, an enterprise security framework and cybersecurity standards, cybersecurity risk and control guidance, security awareness programs and training to build capability, security assessments and continuous monitoring, restricted physical access to hardware and crisis management plans.
- Managing localised or project-specific exposure to technology and cyber risks at the asset, function or project level, including risks associated with business-critical technology systems. Enterprise-level risks that are specific to technology, such as those that pose a greater threat to our wider business and strategic opportunities, are generally managed by our global Technology team and other relevant stakeholders to support delivery of our technology strategy.
- Maturing a Data Strategy to improve data quality and management of critical data that enhances our adoption of digital technologies.
- Monitoring regulatory changes and collaborating with industry stakeholders, research partners and policymakers to design company guidelines (such as our AI Strategy and Framework, and Responsible AI principles) and to develop, implement and maintain technological solutions with appropriate guardrails and controls in place that support compliance with an evolving regulatory environment and meet societal expectations.

#### FY2024 insights

Our exposure increased in FY2024 due to elevated external cybersecurity threat conditions with high-profile cyber incidents experienced by other businesses across Australia and abroad. We continue to monitor and manage the increasing exposure, including through leveraging next generation technologies. Our focus is on strengthening the management of cybersecurity risk and controls across BHP, as well as monitoring third-party events (including in relation to our third-party partners and providers) that may impact our business.

#### For more information refer to

- OFR 2 – What differentiates us
- OFR 6.9 – Climate change

#### Risk factor: Ethical misconduct

##### Examples of potential opportunities

- Our capability to manage ethical misconduct risks may expand portfolio growth options by providing greater assurance that we can operate legally and ethically in high-risk jurisdictions.
- Managing ethical misconduct risks in line with societal, partner and stakeholder expectations may distinguish BHP from competitors and enhance our ability to raise capital, attract and retain talent, engage with governments and communities in new jurisdictions, obtain permits, partner with external organisations or suppliers, or market our products to customers.
- Playing a leading role in the management of ethical misconduct risks, such as sexual harassment risks, may help BHP to increase ethical and behavioural standards across the resources industry.

##### Key management actions

- Setting the ‘tone from the top’ through *Our Charter*, which is central to our business and describes our purpose, values and how we measure success.
- Implementing internal policies, standards, systems and processes for governance and compliance to support an appropriate culture and prioritise respectful behaviours at BHP, including:
  - *Our Code of Conduct (Our Code)* and BHP’s mandatory minimum performance requirements for business conduct, market disclosure and other matters
  - training on *Our Code* and in relation to anti-corruption, market conduct, trade sanctions, data privacy and competition laws
  - ring fencing protocols to separate potentially competing businesses within BHP
  - governance and compliance processes, including procurement and other internal controls, and tailored monitoring of control effectiveness
  - oversight and engagement with high-risk areas by our Ethics and Investigations, Compliance and Internal Audit teams, and the Risk and Audit Committee
  - review and endorsement by our Compliance team of the highest-risk transactions, such as gifts and hospitality, engagement of third parties, community donations and sponsorships above defined thresholds
  - automated counterparty and transaction screening against lists of entities subject to trade sanctions
  - our reporting channels for raising misconduct concerns (comprising an online portal and confidential 24-hour multilingual call service), supported by an ethics and investigations framework and central investigations team
  - campaigns and sessions held globally by our leaders to set expectations around racism, sexual harassment and other disrespectful behaviours, including our ‘Active Bystander’ training that is designed to empower everyone across BHP to call out disrespectful and harmful behaviours
- Continuing to enforce *Our Code* via appropriate investigations and responses, including disciplinary action, in addition to deployment of appropriate controls to prevent harm (including to mental and physical health).
- Requiring anti-corruption and human rights risks to be considered as part of our new country entry approval process.

##### FY2024 insights

Our exposure to ethical misconduct risks increased in FY2024 due to heightened trade sanctions risks, including an increase in the volume and complexity of trade sanctions measures globally. Our Compliance team continues to focus on control enhancements to manage evolving threats (such as trade sanctions) and strengthen key anti-corruption and other compliance controls across the Group, including in relation to the integration of OZ Minerals. With BHP’s continued focus on portfolio growth, there is a potential for further increases in exposure to anti-corruption and other ethical misconduct risks in higher-risk jurisdictions.

#### For more information refer to

- *Our Charter* and *Our Code of Conduct*
- OFR 6.6 – People
- OFR 6.8 – Ethics and business conduct
- OFR 6.11 – Community
- OFR 6.12 – Indigenous peoples
- Corporate Governance Statement

## **Risk factor: Inadequate business resilience**

### **Examples of potential opportunities**

- Risk identification and management supports proactive, focused and prioritised deployment of resources to reduce exposure to adverse events. It may be used to inform priorities and strategies across BHP, supporting a proportionate and cost-effective response, which could provide a competitive advantage at a regional or global level.
- Building wider organisational resilience may enable us to maintain dividends to shareholders amid adverse external events and make growth-generating, counter-cyclical investments, as well as to help us mitigate the impacts of unforeseeable adverse events.
- Adaptation to climate change across our operations and in our value chain could enhance the safety, productivity and climate resilience of our operated assets, position BHP as a supplier of choice and enhance our ability to consistently grow value. Support for climate-vulnerable communities and ecosystems may also improve our social value proposition.

### **Key management actions**

- Implementing Group-wide controls to enhance business resilience, including BHP's mandatory minimum performance requirements for security, crisis and emergency management and business continuity plans, and seeking to maintain an investment grade credit rating.
- Monitoring our current state of readiness (preparedness, redundancy and resilience), including through scenario analysis and business resilience exercises, supporting organisational capability in our operations, functions and senior management to effectively and efficiently respond to and recover from adverse events should they materialise.
- Monitoring the external environment, including political and economic factors, through signal monitoring, our geopolitical monitoring and public policy frameworks and our enterprise-level watch list of emerging themes, to support early identification of policy changes or adverse events for which we may need to increase preparedness.
- Identifying security threats that could directly or indirectly impact our operations and people in countries of interest to BHP.
- Further developing and implementing our adaptation strategy with respect to physical climate-related risks, including requiring operated assets and functions to identify and progressively assess physical climate-related risks (including to our value chain) and seeking to build climate change adaptation into their plans, activities and investments.
- Maintaining quality, centralised climate data covering each of our operating locations so that our people have access to appropriate data to support climate studies that can be used to inform investment decisions around enhancing our operational resilience.

### **FY2024 insights**

Our exposure to risks associated with inadequate business resilience increased in FY2024. The United Nations Framework Convention on Climate Change Secretariat's NDC Synthesis Report (released in November 2023) noted national climate action plans remain insufficient to limit global temperature rises to 1.5°C and, according to the World Meteorological Organisation, CY2023 was the warmest year on record with further natural disasters and prolonged weather events experienced across the globe. Additionally, a global rise in conflict, instability and criminality in CY2023 created new security challenges. Our Security team continues to monitor the evolving external security environment to better understand how it can impact BHP and our industry and how we can manage associated exposure.

### **For more information refer to**

- BHP Climate Change Report 2020
- BHP Climate Transition Action Plan 2024
- OFR 6.1 – Safety
- OFR 6.7 – Health
- OFR 6.9 – Climate change
- OFR 6.10 – Environment and nature
- [bhp.com/sustainability](https://bhp.com/sustainability)

## 9 Performance by commodity

Management believes the following information presented by commodity provides a meaningful indication of the underlying financial and operating performance of the assets, including equity accounted investments, of each reportable segment. Information relating to assets that are accounted for as equity accounted investments is shown to reflect BHP's share, unless otherwise noted, to provide insight into the drivers of these assets.

>For more information as to the statutory determination of our reportable segments refer to Financial Statements note 1 'Segment reporting'

Unit costs is one of our non-IFRS financial measures used to monitor the performance of our individual assets and is included in the analysis of each reportable segment.

>For the definition and method of calculation of our non-IFRS financial measures, including Underlying EBITDA and Unit costs, refer to OFR 10

### 9.1 Copper

Detailed below is financial and operating information for our Copper assets comparing FY2024 to FY2023.

Year ended 30 June

US\$M	2024	2023
Revenue	18,566	16,027
Underlying EBITDA	8,564	6,653
Net operating assets	36,368	34,229
Capital expenditure	3,711	2,698
Underlying ROCE	13%	12%
Total copper production (kt)	1,865	1,717
<i>Average realised prices</i>		
Copper (US\$/lb)	3.98	3.65
<i>Unit Costs</i>		
Escondida (US\$/lb)	1.45	1.40
Spence (US\$/lb)	2.13	2.11
Copper South Australia (US\$/lb) <sup>1</sup>	1.37	—

1. FY2023 comparative is not disclosed as Copper South Australia includes Olympic Dam as well as Prominent Hill and Carrapateena which were acquired on 2 May 2023 as part of the acquisition of OZL which only contributed to the performance of the business from the date of acquisition.

#### Key drivers of Copper's financial results

##### Price overview

Copper prices rose in H2 FY2024, with the LME official cash settlement price hitting a new record high in May on bullish investor sentiment, fuelled by expectations of lower interest rates in the United States, possible copper smelter cuts in China and the LME banning the delivery of Russian metal. However, copper prices then moderated by the end of FY2024, reflecting underlying near-term fundamentals with weak Chinese demand and rising stocks. In the near term, slowing demand growth in China due to continued weakness in the real estate sector is expected to be partially offset by more positive trends in power grid spending and consumer durable goods. We anticipate Europe will be slower to recover from weakness in manufacturing, while the United States will continue to improve more swiftly due to a more resilient underlying economy. We now expect CY2024 to be in marginal surplus, a reflection of softer demand expectations for China and higher supply. In the medium to longer term, traditional demand (such as home building, electrical equipment and household appliances) is expected to remain solid and demand from emerging sectors, such as artificial intelligence and data centres, should add to this. The decarbonisation megatrend is also expected to bolster demand. We anticipate that the cost curve required to meet that demand is likely to steepen as challenges to the development of new resources progressively increase. This implies that should deficits occur in this phase, as we expected they will, fly-up pricing may well occur and in turn this could spur inducement of new, higher cost supply in the long term.

##### Production

Total Copper production for FY2024 increased by 9 per cent to 1,865 kt.

Escondida copper production increased by 7 per cent to 1,125 kt primarily due to higher concentrator feed grade of 0.88 per cent, compared to 0.82 per cent in FY2023. The positive impact of the higher grade was partially offset by planned lower cathode production as a result of prioritising concentrator throughput in prior years.

Pampa Norte copper production decreased by 8 per cent to 266 kt including a record 255 kt at Spence and 11 kt at Cerro Colorado. Spence production increased 6 per cent driven by improved concentrator throughput and increases in both concentrator feed grade and recoveries, partially offset by lower cathode production in line with expected decline in stacked feed grade. Cerro Colorado entered temporary care and maintenance in December 2023.

Copper South Australia copper production increased by 39 per cent to 322 kt from the successful integration of OZ Minerals (OZL) following the acquisition in FY2023. The processing of Prominent Hill and Carrapateena concentrate at Olympic Dam resulted in annual records for cathode and gold production at Olympic Dam. The successful commissioning and ramp up of Crusher 2 led to record material mined and concentrate produced at Carrapateena.

Antamina copper production increased by 4 per cent to 144 kt, as a result of record concentrator throughput offsetting planned lower feed grades. Zinc production was 17 per cent lower at 103 kt, as a result of planned lower feed grades.

Carajás produced 8.4 kt of copper and 5.8 troy koz of gold.



## Financial results

Copper revenue increased by US\$2.5 billion to US\$18.6 billion in FY2024 due to higher average realised copper prices and increased sales volumes following the successful integration of OZL following the acquisition in FY2023.

Underlying EBITDA for Copper increased by US\$1.9 billion to US\$8.6 billion. Price impacts, net of price-linked costs, increased Underlying EBITDA by US\$1.4 billion. Higher sales volumes increased Underlying EBITDA by US\$0.6 billion driven by the successful integration of OZL, higher feed grade at Escondida and record concentrate production at Spence offset by planned lower cathode volumes at Spence.

Controllable cash costs increased by US\$0.2 billion, primarily due to higher maintenance at Escondida and higher exploration spend at Copper South Australia (Copper SA) for drilling activities at Oak Dam.

Favourable foreign exchange rate movements increased EBITDA by US\$0.3 billion.

Inflation negatively impacted Underlying EBITDA by US\$0.3 billion but was offset by lower fuel, energy and consumable price movements of US\$0.3 billion. An increase in Non-cash costs of US\$0.3 billion related to lower stripping capitalisation at Escondida and Spence, reflecting the phase of the respective mine plans.

## Outlook

Total Copper production of between 1,845 and 2,045 kt is expected in FY2025.

Escondida production of between 1,180 and 1,300 kt is expected in FY2025, reflecting both an expected increase in concentrator feed grade and throughput compared to FY2024.

Spence production of between 240 and 270 kt is expected in FY2025.

Copper South Australia production of between 310 and 340 kt is expected in FY2025.

Antamina copper production of between 115 to 135 kt due to mine sequencing resulting in lower throughput, and zinc production of between 90 and 110 kt is expected in FY2025.

Escondida unit costs in FY2025 are expected to be between US\$1.30 and US\$1.60 per pound (at an exchange rate of USD/CLP 842).

Spence unit costs in FY2025 are expected to be between US\$2.00 and US\$2.30 per pound (at an exchange rate of USD/CLP 842).

Copper South Australia unit costs in FY2025 are expected to be between US\$1.30 and US\$1.80 per pound (at an exchange rate of AUD/USD 0.66).

## Prior year comparatives

The comparison for the year ended 30 June 2023 to 30 June 2022 has been omitted from this annual report on Form 20-F and can be found in our annual report on Form 20-F for the fiscal year ended 30 June 2023, filed on 5 September 2023.

## 9.2 Iron Ore

Detailed below is financial and operating information for our Iron Ore assets comparing FY2024 to FY2023.

### Year ended 30 June

US\$M	2024	2023
Revenue	27,952	24,812
Underlying EBITDA	18,913	16,692
Net operating assets	13,812	16,956
Capital expenditure	2,033	1,966
Underlying ROCE	83%	67%
Total iron ore production (Mt)	260	257
<i>Average realised prices</i>		
Iron ore (US\$/wmt, FOB)	101.04	92.54
<i>Unit Costs</i>		
WAIO (US\$/t)	18.19	17.79

## Key drivers of Iron Ore's financial results

### Price overview

Iron ore consumption in China was strong in CY2023. In contrast, steel output continued to contract in developed regions albeit at a slower rate than previous years. Over the next two years we expect a small improvement in global steel production with growth led by India and Southeast Asia, with some additional growth from a recovery in developed regions. After a strong CY2023, we expect Chinese blast furnace run rates to ease in CY2024, under pressure from subdued steel margins and the potential for policy-driven production controls. During H2 FY2024, iron ore prices first declined and then traded in the range of around US\$100 to US\$120/t. A widening surplus has emerged with Chinese port inventories rising to elevated levels. For the balance of CY2024 and into CY2025, we expect supply from low-cost major iron ore producers to grow while iron ore consumption is experiencing a modest decline. Our estimate of real-time cost support continues to sit in the US\$80 – US\$100/t range on a 62% Fe CFR basis. Should surpluses persist as we forecast, we would expect some high-cost suppliers may be driven out of the market over time. How quickly and effectively the Chinese policies targeted at the property sector stabilise it, and the government's approach to regulating steel production, will both be large swing factors for the remainder of CY2024 and into CY2025. In the medium term, China's demand for iron ore is expected to be lower than it is today as it moves beyond the crude steel production plateau and as the ratio of scrap-based steelmaking rises. We maintain our view that China's steel production has plateaued above 1.0 and this is likely to continue across the mid-2020s. However, Chinese pig iron production is expected to decline during this period with more recycled scrap used in steelmaking. We expect demand for our products in other developing regions in Asia to offset this to a degree.

## Production

Total Iron Ore production increased by 1 per cent to a record 260 Mt.

WAIO achieved record production of 255 Mt (287 Mt on a 100 per cent basis), reflecting strong supply chain performance with increased capacity unlocked by the Port Debottlenecking Project 1 (PDP1) and record production at South Flank. These more than offset the impacts of the continued tie-in activity for the Rail Technology Programme 1 (RTP1). South Flank completed ramp up to full production capacity of 80 Mtpa (100 per cent basis) in FY2024 and following commissioning in December 2023, ramp up of PDP1 remains on track to be completed in C'Y2024.

Samarco production increased by 5 per cent to 4.7 Mt (BHP share), as a result of higher concentrator throughput.

## Financial results

Total Iron Ore revenue increased by US\$3.1 billion to US\$28.0 billion in FY2024, reflecting higher average realised prices and higher sales volumes as a result of record production from strong supply chain performance with increased capacity unlocked by PDP1 and record production at South Flank.

Underlying EBITDA for Iron Ore increased by US\$2.2 billion to US\$18.9 billion primarily due to higher average realised prices, net of price-linked costs, of US\$2.0 billion. Higher sales volumes increased Underlying EBITDA by US\$0.6 billion driven by record production partially offset by US\$0.2 billion of higher controllable cash costs as we ramped up South Flank and increased production. Other items, such as inflation and unfavourable foreign exchange rate impacts, were partially offset by lower fuel, energy and consumable price movements collectively reduced Underlying EBITDA by US\$0.2 billion.

## Outlook

WAIO production is expected to be between 250 and 260 Mt (282 and 294 Mt on a 100 per cent basis) in FY2025 as the Group ramps up the planned tie-in activities for RTP1.

WAIO unit costs in FY2025 are expected to be between US\$18.00 and US\$19.50 per tonne (based on an exchange rate of AUD/USD 0.66).

Samarco production is expected to be between 5 and 5.5 Mt (BHP share) in FY2025 with the second concentrator expected to come online during Q3 FY2025.

## Prior year comparatives

The comparison for the year ended 30 June 2023 to 30 June 2022 has been omitted from this annual report on Form 20-F and can be found in our annual report on Form 20-F for the fiscal year ended 30 June 2023, filed on 5 September 2023.

## 9.3 Coal

Detailed below is financial and operating information for our Coal assets comparing FY2024 to FY2023.

### Year ended 30 June

US\$M	2024	2023
Revenue	7,666	10,958
Underlying EBITDA	2,290	4,998
Net operating assets	6,472	7,266
Capital expenditure	646	657
Underlying ROCE	19%	47%
Total steelmaking coal production (Mt)	22	29
Total energy coal production (Mt)	15	14
<i>Average realised prices</i>		
Steelmaking coal (US\$/t)	266.06	271.05
Hard coking coal (HCC) (US\$/t)	273.03	273.59
Weak coking coal (WCC) (US\$/t)	205.54	251.13
Thermal coal (US\$/t)	121.52	236.51
<i>Unit Costs</i>		
BMA (US\$/t)	119.54	96.46

## Key drivers of Coal's financial results

### Price overview

Across FY2024, steelmaking coal prices were relatively stable with an overall slight decline in prices. The demand picture was mixed with strong Indian steel production growth and recovery in the EU from the lows of CY2023, offsetting output contractions in both Northeast Asia and North America. Against this backdrop, Australian supply recovered slower than expectations, while Mongolian exports continued to surge. Notwithstanding recent supply side challenges, we still expect a modest recovery of seaborne supply in the near term. Meanwhile, availability of land borne imports into China and operational recovery of Chinese domestic mines are key uncertainties. On seaborne demand, India is expected to maintain its current strong momentum while OECD importing regions are likely to experience a gradual pickup in their steel industries. While seaborne supply in the steelmaking coal market is expected see a marginal surplus in CY2025 the supply of higher-quality coals is likely to stay relatively tight. Over the longer term, we expect that higher-quality steelmaking coals, such as those produced by our BMA assets, will be valued for their role in reducing the GHG emissions intensity of blast furnaces and, combined with the growth of the steel industry in hard coking coal importing countries such as India, will have growing and resilient demand for decades to come. With the major seaborne supply region of Queensland being currently less conducive to long-life capital investment as a result of changes to the royalty regime, the scarcity value of higher-quality steelmaking coals may well also increase over time.

### Production

#### Steelmaking coal

BMA production decreased by 23 per cent to 22.3 Mt (44.6 Mt on a 100 per cent basis) as a result of increased stripping to improve supply chain stability and restore depleted inventory positions, which arose from extended weather impacts and labour constraints over recent years, and the divestment of Blackwater and Daunia on 2 April 2024. Production was also impacted by an extended longwall move and geotechnical faulting at Broadmeadow during H1 FY2024, and the temporary suspension of operations following the fatality of a team member at Saraji. Blackwater and Daunia produced 5 Mt (10 Mt on a 100 per cent basis) in FY2024 prior to their divestment.

#### Energy coal

NSWEC production increased by 8 per cent to 15.4 Mt due to strong operating performance as improved weather and labour availability enabled an uplift in truck productivity.

### Financial results

Coal revenue decreased by US\$3.3 billion to US\$7.7 billion in FY2024 mainly due to lower average realised prices, lower volumes at BMA as a result of increased stripping to improve supply chain stability and the divestment of Blackwater and Daunia, partially offset by higher volumes at NSWEC due to strong operating performance.

Underlying EBITDA for Coal decreased by US\$2.7 billion to US\$2.3 billion. Price impacts, net of price-linked costs, decreased Underlying EBITDA by US\$1.5 billion.

Lower sales volumes of US\$1.0 billion were due to lower production at BMA, including the divestment of Blackwater and Daunia, partially offset by higher production at NSWEC. Inflation negatively impacted Underlying EBITDA by US\$0.1 billion and controllable cash costs increased by US\$0.1 billion from higher stripping and contractor costs to support higher production at NSWEC.

### Outlook

BMA coal production for FY2025 is expected to be between 16.5 and 19 Mt (33 and 38 Mt on a 100 per cent basis), reflecting the divestment of Blackwater and Daunia and impact of elevated strip ratios as we continue to improve supply chain stability and re-establish raw coal inventory positions.

BMA unit costs in FY2025 are expected to be between US\$112 and US\$124 per tonne (based on an exchange rate of AUD/USD 0.66).

NSWEC coal production for FY2025 is expected to be between 13 and 15 Mt.

### Prior year comparatives

The comparison for the year ended 30 June 2023 to 30 June 2022 has been omitted from this annual report on Form 20-F and can be found in our annual report on Form 20-F for the fiscal year ended 30 June 2023, filed on 5 September 2023.

## 9.4 Other assets

Detailed below is an analysis of Other assets' financial and operating performance comparing FY2024 to FY2023.

### Western Australia Nickel

#### Key drivers of Western Australia Nickel's financial results

##### Price overview

The nickel industry moved into significant surplus during CY2023. Indonesia produced almost 20 per cent of global primary nickel in CY2019, and that share increased to over 50 per cent by CY2023. This came at a time of weak traditional stainless steel demand in the OECD and global battery value chain destocking. The nickel market weakness has continued into CY2024 albeit with a brief price rebound in May on supply curtailments and disruptions in Australia and New Caledonia. On the demand side, electric vehicle sales remained solid in China, but penetration rates in the OECD have slowed in parallel with weaker traditional stainless steel demand for nickel, which caused global visible nickel stocks to rise. These trends are expected to continue into CY2025 suggesting that the market will remain in surplus over that period. While voluntary curtailments continue to occur across the industry, including by BHP, these are still not near the scale that would be expected to balance the market near term. We estimate that we are still in a multi-year run of surpluses. Longer term, we see the market rebalancing in the late 2020s as we continue to believe nickel will be a core beneficiary of the electrification megatrend.

## Production

Nickel West production increased by 2 per cent to 81.6 kt, as we produced a higher proportion of the lower value matte products as a result of increased maintenance at Kwinana Refinery and severe weather events.

## Financial results

Western Australia Nickel revenue decreased by US\$0.5 billion to US\$1.5 billion in FY2024, reflecting lower average realised prices.

Underlying EBITDA for Western Australia Nickel decreased by US\$0.5 billion to a loss of US\$0.3 billion. Price impacts, net of price-linked costs, decreased Underlying EBITDA by US\$0.4 billion. Controllable cash costs increased by US\$0.1 billion due to increased third-party ore purchases following delivery issues in FY2023.

## Outlook

On 11 July 2024, we announced the temporary suspension of operations at Western Australia Nickel and that operations will be suspended by October 2024 and handover activities for temporary suspension will be completed by December 2024. BHP intends to review the decision to temporarily suspend Western Australia Nickel by February 2027.

## Potash

Potash recorded an Underlying EBITDA loss of US\$255 million in FY2024, compared to a loss of US\$205 million in FY2023.

Jansen Stage 1 is 52 per cent complete and remains on track for first production in late CY2026 with a two-year expected ramp up period. The engineering work and execution of procurement agreements is largely complete. In FY2024, a longer than usual summer season enabled early completion of the mill's foundation. In FY2025, underground and surface construction works will continue, including structural, mechanical and electrical activities for the mill areas. The Group also expects to complete the conversion of the service shaft headframe to a permanent structure.

Jansen Stage 2 execution activity has now commenced and is 2 per cent complete, with first production expected in FY2029, followed by an expected three-year ramp-up period. In FY2025, the focus will be on detailed engineering, procurement for major equipment and construction packages, and structural steel fabrication.

## Price overview

Potash demand has been strong in CY2024, after a sharp rebound in CY2023, with global potash shipments this year estimated to return to its previous CY2020 peak level of 72 Mtpa, driven by good affordability and inventory build-up. In the medium-term existing capacity in the FSU is expected to trend back to normal operating rates, while new supply could also come from the region, including some expansion projects potentially resuming construction. Longer term, we believe that potash stands to benefit from the intersection of global megatrends: rising population, changing diets and the need for the more sustainable intensification of agriculture on the globe's finite arable land. We consider this compelling demand picture, rising geopolitical uncertainty and the maturity of the existing production asset base to provide an attractive entry opportunity in a lower-risk supply jurisdiction such as Saskatchewan, Canada.

## Prior year comparatives

The comparison for the year ended 30 June 2023 to 30 June 2022 has been omitted from this annual report on Form 20-F and can be found in our annual report on Form 20-F for the fiscal year ended 30 June 2023, filed on 5 September 2023.

## 9.5 Impact of changes to commodity prices

The prices we obtain for our products are a key driver of value for BHP. Fluctuations in these commodity prices affect our results, including cash flows and asset values. The estimated impact of changes in commodity prices in FY2024 on our key financial measures is set out below.

	Impact on profit after taxation (US\$M)	Impact on Underlying EBITDA (US\$M)
US\$1/lb on copper price	26	37
US\$1/t on iron ore price	163	233
US\$1/t on steelmaking coal price	7	10
US\$1/t on energy coal price	10	14
US\$1/lb on nickel price	1	1

## 10 Non-IFRS financial information

We use various non-IFRS financial information to reflect our underlying financial performance.

Non-IFRS financial information is not defined or specified under the requirements of IFRS, but is derived from the Group's Consolidated Financial Statements prepared in accordance with IFRS. The non-IFRS financial information and the below reconciliations included in this Report are unaudited. The non-IFRS financial information presented is consistent with how management reviews financial performance of the Group with the Board and the investment community.

Sections 10.1 and 10.2 outline why we believe non-IFRS financial information is useful and the calculation methodology. We believe non-IFRS financial information provides useful information, however should not be considered as an indication of, or as a substitute for, statutory measures as an indicator of actual operating performance (such as profit or net operating cash flow) or any other measure of financial performance or position presented in accordance with IFRS, or as a measure of a company's profitability, liquidity or financial position.

The following tables provide reconciliations between non-IFRS financial information and their nearest respective IFRS measure.

### Exceptional items

To improve the comparability of underlying financial performance between reporting periods, some of our non-IFRS financial information adjusts the relevant IFRS measures for exceptional items.

>For more information on exceptional items refer to Financial Statements note 3 'Exceptional items'

Exceptional items are those gains or losses where their nature, including the expected frequency of the events giving rise to them, and impact is considered material to the Group's Consolidated Financial Statements. The exceptional items included within the Group's profit for the financial years are detailed below.

Year ended 30 June	2024 US\$M	2023 US\$M	2022 US\$M
<b>Continuing operations</b>			
Revenue	–	–	–
Other income	877	–	840
Expenses excluding net finance costs, depreciation, amortisation and impairments	(139)	(103)	(494)
Depreciation and amortisation	–	–	–
Net impairments	(3,800)	–	–
(Loss)/profit from equity accounted investments, related impairments and expenses	(3,032)	215	(676)
<b>Profit/(loss) from operations</b>	<b>(6,094)</b>	<b>112</b>	<b>(330)</b>
Financial expenses	(506)	(452)	(290)
Financial income	–	–	–
<b>Net finance costs</b>	<b>(506)</b>	<b>(452)</b>	<b>(290)</b>
<b>Profit/(loss) before taxation</b>	<b>(6,600)</b>	<b>(340)</b>	<b>(620)</b>
Income tax (expense)/benefit	837	(266)	(454)
Royalty-related taxation (net of income tax benefit)	–	–	–
<b>Total taxation (expense)/benefit</b>	<b>837</b>	<b>(266)</b>	<b>(454)</b>
<b>Profit/(loss) after taxation from Continuing operations</b>	<b>(5,763)</b>	<b>(606)</b>	<b>(1,074)</b>
<b>Discontinued operations</b>			
Profit/(loss) after taxation from Discontinued operations	–	–	8,159
<b>Profit/(loss) after taxation from Continuing and Discontinued operations</b>	<b>(5,763)</b>	<b>(606)</b>	<b>7,085</b>
Total exceptional items attributable to non-controlling interests	–	(107)	–
<b>Total exceptional items attributable to BHP shareholders</b>	<b>(5,763)</b>	<b>(499)</b>	<b>7,085</b>
Exceptional items attributable to BHP shareholders per share (US cents)	(113.7)	(9.8)	140.0
Weighted basic average number of shares (Million)	5,068	5,064	5,061

## Non-IFRS financial information derived from Consolidated Income Statement

### Underlying attributable profit

	2024	2023	2022
Year ended 30 June	US\$M	US\$M	US\$M
Profit after taxation from Continuing and Discontinued operations attributable to BHP shareholders	7,897	12,921	30,900
Total exceptional items attributable to BHP shareholders <sup>1</sup>	5,763	499	(7,085)
<b>Underlying attributable profit</b>	<b>13,660</b>	<b>13,420</b>	<b>23,815</b>

1. For more information refer to Financial Statements note 3 'Exceptional items'.

### Underlying basic earnings per share

	2024	2023	2022
Year ended 30 June	US cents	US cents	US cents
Basic earnings per ordinary share	155.8	255.2	610.6
Exceptional items attributable to BHP shareholders per share <sup>1</sup>	113.7	9.8	(140.0)
<b>Underlying basic earnings per ordinary share</b>	<b>269.5</b>	<b>265.0</b>	<b>470.6</b>

1. For more information refer to Financial Statements note 3 'Exceptional items'.

### Underlying attributable profit – Continuing operations

	2024	2023	2022
Year ended 30 June	US\$M	US\$M	US\$M
Profit after taxation from Continuing and Discontinued operations attributable to BHP shareholders	7,897	12,921	30,900
(Profit)/loss after taxation from Discontinued operations attributable to members of BHP	–	–	(10,655)
Total exceptional items attributable to BHP shareholders <sup>1</sup>	5,763	499	(7,085)
Total exceptional items attributable to BHP shareholders for Discontinued operations <sup>2</sup>	–	–	8,159
<b>Underlying attributable profit – Continuing operations</b>	<b>13,660</b>	<b>13,420</b>	<b>21,319</b>

1. For more information refer to Financial Statements note 3 'Exceptional items'.

2. For more information refer to Financial Statements note 28 'Discontinued operations'.

### Underlying basic earnings per share – Continuing operations

	2024	2023	2022
Year ended 30 June	US\$M	US\$M	US\$M
Underlying attributable profit – Continuing operations	13,660	13,420	21,319
Weighted basic average number of shares (Million)	5,068	5,064	5,061
<b>Underlying attributable earnings per ordinary share – Continuing operations (US cents)</b>	<b>269.5</b>	<b>265.0</b>	<b>421.2</b>

### Underlying EBITDA

	2024	2023	2022
Year ended 30 June	US\$M	US\$M	US\$M
Profit from operations	17,537	22,932	34,106
Exceptional items included in profit from operations <sup>1</sup>	6,094	(112)	330
<b>Underlying EBIT</b>	<b>23,631</b>	<b>22,820</b>	<b>34,436</b>
Depreciation and amortisation expense	5,295	5,061	5,683
Net impairments	3,890	75	515
Exceptional item included in Depreciation, amortisation and impairments <sup>1</sup>	(3,800)	–	–
<b>Underlying EBITDA</b>	<b>29,016</b>	<b>27,956</b>	<b>40,634</b>

1. For more information refer to Financial Statements note 3 'Exceptional items'.

## Underlying EBITDA – Segment

				Group and unallocated items/ eliminations <sup>2</sup>	Total Group
<b>Year ended 30 June 2024</b>					
US\$M	<u>Copper</u>	<u>Iron Ore</u>	<u>Coal</u>		
Profit from operations	6,524	13,759	2,557	(5,303)	17,537
Exceptional items included in profit from operations <sup>1</sup>	–	3,066	(880)	3,908	6,094
Depreciation and amortisation expense	2,023	2,027	611	634	5,295
Net impairments	17	61	2	3,810	3,890
Exceptional item included in Depreciation, amortisation and impairments <sup>1</sup>	–	–	–	(3,800)	(3,800)
<b>Underlying EBITDA</b>	<b>8,564</b>	<b>18,913</b>	<b>2,290</b>	<b>(751)</b>	<b>29,016</b>
<b>Year ended 30 June 2023</b>					
US\$M	<u>Copper</u>	<u>Iron Ore</u>	<u>Coal</u>	Group and unallocated items/ eliminations <sup>2</sup>	Total Group
Profit from operations	4,810	14,847	4,295	(1,020)	22,932
Exceptional items included in profit from operations <sup>1</sup>	–	(176)	–	64	(112)
Depreciation and amortisation expense	1,810	1,993	697	561	5,061
Net impairments	33	28	6	8	75
<b>Underlying EBITDA</b>	<b>6,653</b>	<b>16,692</b>	<b>4,998</b>	<b>(387)</b>	<b>27,956</b>
<b>Year ended 30 June 2022</b>					
US\$M	<u>Copper</u>	<u>Iron Ore</u>	<u>Coal</u>	Group and unallocated items/ eliminations <sup>2</sup>	Total Group
Profit from operations	6,330	18,742	9,582	(548)	34,106
Exceptional items included in profit from operations <sup>1</sup>	–	729	(849)	450	330
Depreciation and amortisation expense	1,765	2,203	762	953	5,683
Net impairments	470	33	9	3	515
<b>Underlying EBITDA</b>	<b>8,565</b>	<b>21,707</b>	<b>9,504</b>	<b>858</b>	<b>40,634</b>

1. For more information refer to Financial Statements note 3 'Exceptional items'.

2. Group and unallocated items includes functions, other unallocated operations including Potash, Western Australia Nickel (which comprises the Nickel West operations and, following the OZ Minerals (OZL) acquisition on 2 May 2023, the West Musgrave project), legacy assets and consolidation adjustments.

Year ended 30 June 2024	Profit from operations	Exceptional items included in profit from operations <sup>1</sup>	Depreciation and amortisation	Net impairments	Exceptional items included in Depreciation, amortisation and impairments <sup>1</sup>	Underlying EBITDA
US\$M						
Potash	(257)	–	2	–	–	(255)
Western Australia Nickel <sup>2</sup>	(4,174)	3,800	72	3,800	(3,800)	(302)
Other <sup>3</sup>	(872)	108	560	10	–	(194)
<b>Total</b>	<b>(5,303)</b>	<b>3,908</b>	<b>634</b>	<b>3,810</b>	<b>(3,800)</b>	<b>(751)</b>

Year ended 30 June 2023	Profit from operations	Exceptional items included in profit from operations <sup>1</sup>	Depreciation and amortisation	Net impairments	Exceptional items included in Depreciation, amortisation and impairments <sup>1</sup>	Underlying EBITDA
US\$M						
Potash	(207)	–	2	–	–	(205)
Western Australia Nickel <sup>2</sup>	55	–	105	2	–	162
Other <sup>3</sup>	(868)	64	454	6	–	(344)
<b>Total</b>	<b>(1,020)</b>	<b>64</b>	<b>561</b>	<b>8</b>	<b>–</b>	<b>(387)</b>

Year ended 30 June 2022	Profit from operations	Exceptional items included in profit from operations <sup>1</sup>	Depreciation and amortisation	Net impairments	Exceptional items included in Depreciation, amortisation and impairments <sup>1</sup>	Underlying EBITDA
US\$M						
Potash	(149)	–	2	–	–	(147)
Western Australia Nickel <sup>2</sup>	327	–	91	2	–	420
Other <sup>3</sup>	(726)	450	860	1	–	585
<b>Total</b>	<b>(548)</b>	<b>450</b>	<b>953</b>	<b>3</b>	<b>–</b>	<b>858</b>

1. For more information refer to Financial Statements note 3 'Exceptional items'.

2. Western Australia Nickel comprises the Nickel West operations and, following the OZL acquisition on 2 May 2023, the West Musgrave project.

3. Other includes functions, other unallocated operations, legacy assets and consolidation adjustments.

#### Underlying EBITDA margin

Year ended 30 June 2024	Copper	Iron Ore	Coal	Group and unallocated items/ eliminations <sup>1</sup>	Total Group
US\$M					
Revenue – Group production	16,545	27,927	7,666	1,470	53,608
Revenue – Third-party products	2,021	25	–	4	2,050
<b>Revenue</b>	<b>18,566</b>	<b>27,952</b>	<b>7,666</b>	<b>1,474</b>	<b>55,658</b>
Underlying EBITDA – Group production	8,490	18,916	2,290	(753)	28,943
Underlying EBITDA – Third-party products	74	(3)	–	2	73
<b>Underlying EBITDA<sup>2</sup></b>	<b>8,564</b>	<b>18,913</b>	<b>2,290</b>	<b>(751)</b>	<b>29,016</b>
Segment contribution to the Group's Underlying EBITDA <sup>3</sup>	29%	64%	7%		100%
Underlying EBITDA margin <sup>4</sup>	51%	68%	30%		54%



Year ended 30 June 2023		Copper	Iron Ore	Coal	Group and unallocated items/ eliminations <sup>1</sup>	Total Group
US\$M						
Revenue – Group production		14,164	24,791	10,958	2,009	51,922
Revenue – Third-party products		1,863	21	–	11	1,895
Revenue		16,027	24,812	10,958	2,020	53,817
Underlying EBITDA – Group production		6,635	16,693	4,998	(387)	27,939
Underlying EBITDA – Third-party products		18	(1)	–	–	17
Underlying EBITDA <sup>2</sup>		6,653	16,692	4,998	(387)	27,956
Segment contribution to the Group's Underlying EBITDA <sup>3</sup>		23%	59%	18%		100%
Underlying EBITDA margin <sup>4</sup>		47%	67%	46%		54%

Year ended 30 June 2022		Copper	Iron Ore	Coal	Group and unallocated items/ eliminations <sup>1</sup>	Total Group
US\$M						
Revenue – Group production		13,946	30,748	15,549	1,860	62,103
Revenue – Third-party products		2,903	19	–	73	2,995
Revenue		16,849	30,767	15,549	1,933	65,098
Underlying EBITDA – Group production		8,529	21,707	9,504	858	40,598
Underlying EBITDA – Third-party products		36	–	–	–	36
Underlying EBITDA <sup>2</sup>		8,565	21,707	9,504	858	40,634
Segment contribution to the Group's Underlying EBITDA <sup>3</sup>		22%	54%	24%		100%
Underlying EBITDA margin <sup>4</sup>		61%	71%	61%		65%

1. Group and unallocated items includes functions, other unallocated operations including Potash, Western Australia Nickel (which comprises the Nickel West operations and, following the OZL acquisition on 2 May 2023, the West Musgrave project), legacy assets and consolidation adjustments.
2. We differentiate sales of our production (which may include third-party product feed) from direct sales of third-party products to better measure our operational profitability as a percentage of revenue. We may buy and sell third-party products to ensure a steady supply of product to our customers where there is occasional production variability or shortfalls from our assets.
3. Percentage contribution to Group Underlying EBITDA, excluding Group and unallocated items.
4. Underlying EBITDA margin excludes third-party products.

## Effective tax rate

Year ended 30 June	2024			2023			2022		
	Profit before taxation US\$M	Income tax expense US\$M	%	Profit before taxation US\$M	Income tax expense US\$M	%	Profit before taxation US\$M	Income tax expense US\$M	%
<b>Statutory effective tax rate</b>	<b>16,048</b>	<b>(6,447)</b>	<b>40.2</b>	21,401	(7,077)	33.1	33,137	(10,737)	32.4
<i>Adjusted for:</i>									
Exchange rate movements	–	(79)		–	94		–	(233)	
Exceptional items <sup>1</sup>	<b>6,600</b>	<b>(837)</b>		340	266		620	454	
<b>Adjusted effective tax rate</b>	<b>22,648</b>	<b>(7,363)</b>	<b>32.5</b>	21,741	(6,717)	30.9	33,757	(10,516)	31.2

1. For more information refer to Financial Statements note 3 'Exceptional items'.

## Non-IFRS financial information derived from Consolidated Cash Flow Statement

### Capital and exploration expenditure

Year ended 30 June	2024 US\$M	2023 US\$M	2022 US\$M
Capital expenditure (purchases of property, plant and equipment)	<b>8,816</b>	6,733	5,855
Add: Exploration and evaluation expenditure	<b>457</b>	350	256
<b>Capital and exploration expenditure (cash basis) – Continuing operations</b>	<b>9,273</b>	7,083	6,111
Capital expenditure (purchases of property, plant and equipment) – Discontinued operations	–	–	1,050
Add: Exploration and evaluation expenditure – Discontinued operations	–	–	384
<b>Capital and exploration expenditure (cash basis) – Discontinued operations</b>	–	–	1,434
<b>Capital and exploration expenditure (cash basis) – Total operations</b>	<b>9,273</b>	7,083	7,545

### Free cash flow

Year ended 30 June	2024 US\$M	2023 US\$M	2022 US\$M
Net operating cash flows from Continuing operations	<b>20,665</b>	18,701	29,285
Net investing cash flows from Continuing operations	<b>(8,762)</b>	(13,065)	(4,973)
<b>Free cash flow – Continuing operations</b>	<b>11,903</b>	5,636	24,312
Net operating cash flows from Discontinued operations	–	–	2,889
Net investing cash flows from Discontinued operations	–	–	(904)
Net cash completion payment on merger of Petroleum with Woodside	–	–	(683)
Cash and cash equivalents disposed on merger of Petroleum with Woodside	–	–	(399)
<b>Free cash flow – Discontinued operations</b>	–	–	903
<b>Free cash flow – Total operations</b>	<b>11,903</b>	5,636	25,215

## Non-IFRS financial information derived from Consolidated Balance Sheet

### Net debt and gearing ratio

Year ended 30 June	2024 US\$M	2023 US\$M	2022 US\$M
Interest bearing liabilities – Current	2,084	7,173	2,622
Interest bearing liabilities – Non-current	18,634	15,172	13,806
<b>Total interest bearing liabilities</b>	<b>20,718</b>	<b>22,345</b>	<b>16,428</b>
<b>Comprising:</b>			
Borrowing	17,602	19,326	13,852
Lease liabilities	3,116	3,019	2,576
<b>Less: Lease liability associated with index-linked freight contracts</b>	<b>511</b>	<b>287</b>	<b>274</b>
<b>Less: Cash and cash equivalents</b>	<b>12,501</b>	<b>12,428</b>	<b>17,236</b>
Less: Net debt management related instruments <sup>1</sup>	(1,395)	(1,572)	(1,688)
Less: Net cash management related instruments <sup>2</sup>	(19)	36	273
<b>Less: Total derivatives included in net debt</b>	<b>(1,414)</b>	<b>(1,536)</b>	<b>(1,415)</b>
<b>Net debt</b>	<b>9,120</b>	<b>11,166</b>	<b>333</b>
Net assets	49,120	48,530	48,766
<b>Gearing</b>	<b>15.7%</b>	<b>18.7%</b>	<b>0.7%</b>

1. Represents the net cross currency and interest rate swaps included within current and non-current other financial assets and liabilities.

2. Represents the net forward exchange contracts related to cash management included within current and non-current other financial assets and liabilities.

### Net debt waterfall

Year ended 30 June	2024 US\$M	2023 US\$M
<b>Net debt at the beginning of the period</b>	<b>(11,166)</b>	<b>(333)</b>
Net operating cash flows	20,665	18,701
Net investing cash flows	(8,762)	(13,065)
Net financing cash flows	(11,669)	(10,315)
<b>Net increase/(decrease) in cash and cash equivalents from Continuing and Discontinued operations</b>	<b>234</b>	<b>(4,679)</b>
<b>Carrying value of interest bearing liability net repayments/(proceeds)</b>	<b>2,236</b>	<b>(4,893)</b>
<b>Carrying value of debt related instruments settlements</b>	<b>321</b>	<b>677</b>
<b>Carrying value of cash management related instruments proceeds</b>	<b>(361)</b>	<b>(331)</b>
Fair value change on hedged loans	214	803
Fair value change on hedging derivatives	(188)	(691)
Foreign currency exchange rate changes on cash and cash equivalents	(159)	(134)
Lease additions (excluding leases associated with index-linked freight contracts)	(429)	(472)
Acquisition of subsidiaries and operations <sup>1</sup>	–	(1,111)
Divestment of subsidiaries and operations <sup>2</sup>	60	–
Other	118	(2)
<b>Non-cash movements</b>	<b>(384)</b>	<b>(1,607)</b>
<b>Net debt at the end of the period</b>	<b>(9,120)</b>	<b>(11,166)</b>

1. US\$1,111 million of Interest bearing liabilities were acquired on 2 May 2023 as part of the acquisition of OZL. Excludes US\$104 million cash acquired which is included in Net investing cash flows.

2. Relates to leases disposed as part of the Blackwater and Daunia mines divestment completed on 2 April 2024. Refer to Financial Statements note 3 'Exceptional items' for further information.

## Net operating assets

The following table reconciles Net operating assets for the Group to Net assets on the Consolidated Balance Sheet.

Year ended 30 June	2024 US\$M	2023 US\$M
<b>Net assets</b>	<b>49,120</b>	<b>48,530</b>
Less: Non-operating assets		
Cash and cash equivalents	(12,501)	(12,428)
Trade and other receivables <sup>1</sup>	(306)	(26)
Other financial assets <sup>2</sup>	(1,398)	(996)
Current tax assets	(314)	(508)
Deferred tax assets	(67)	(56)
Add: Non-operating liabilities		
Trade and other payables <sup>3</sup>	297	277
Interest bearing liabilities	20,718	22,345
Other financial liabilities <sup>4</sup>	1,558	1,764
Current tax payable	884	611
Non-current tax payable	40	68
Deferred tax liabilities	3,332	4,299
<b>Net operating assets</b>	<b>61,363</b>	<b>63,880</b>
<b>Net operating assets</b>		
Copper	36,368	34,229
Iron Ore	13,812	16,956
Coal	6,472	7,266
Group and unallocated items <sup>5</sup>	4,711	5,429
<b>Total</b>	<b>61,363</b>	<b>63,880</b>

1. Represents external finance receivable, receivables related to divestment of subsidiaries and operations and accrued interest receivable included within other receivables.

2. Represents cross currency and interest rate swaps, forward exchange contracts related to cash management and investment in shares, other investments, deferred receivable from divestment of subsidiaries and operations and associated receivables contingent on outcome of future events relating to realised commodity prices.

3. Represents accrued interest payable included within other payables.

4. Represents cross currency and interest rate swaps and forward exchange contracts related to cash management.

5. Group and unallocated items includes functions, other unallocated operations including Potash, Western Australia Nickel (which comprises the Nickel West operations and, following the OZL acquisition on 2 May 2023, the West Musgrave project), legacy assets and consolidation adjustments.

## Other non-IFRS financial information

### Principal factors that affect Revenue, Profit from operations and Underlying EBITDA

The following table describes the impact of the principal factors that affected Revenue, Profit from operations and Underlying EBITDA for FY2024 and relates them back to our Consolidated Income Statement.

>For information on the method of calculation of the principal factors that affect Revenue, Profit from operations and Underlying EBITDA refer to OFR 10.2

	Revenue US\$M	Total expenses, Other income and Profit/ (loss) from equity accounted investments US\$M	Profit from operations US\$M	Depreciation, amortisation and impairments and Exceptional Items US\$M	Underlying EBITDA US\$M
<b>Year ended 30 June 2023</b>					
Revenue	53,817				
Other income		394			
Expenses excluding net finance costs		(31,873)			
Profit/(loss) from equity accounted investments, related impairments and expenses		594			
Total other income, expenses excluding net finance costs and Profit/(loss) from equity accounted investments, related impairments and expenses		(30,885)			
<b>Profit from operations</b>			22,932		
Depreciation, amortisation and impairments <sup>1</sup>				5,136	
Exceptional item included in Depreciation, amortisation and impairments				–	
Exceptional items				(112)	
<b>Underlying EBITDA</b>					27,956
Change in sales prices	1,476	–	1,476	–	1,476
Price-linked costs	–	108	108	–	108
<b>Net price impact</b>	1,476	108	1,584	–	1,584
<b>Change in volumes</b>	55	(45)	10	–	10
Operating cash costs	–	(655)	(655)	–	(655)
Exploration and business development	–	(118)	(118)	–	(118)
<b>Change in controllable cash costs<sup>2</sup></b>	–	(773)	(773)	–	(773)
Exchange rates	(1)	254	253	–	253
Inflation on costs	–	(686)	(686)	–	(686)
Fuel, energy and consumable price movements	–	487	487	–	487
Non-cash	–	(301)	(301)	–	(301)
One-off items	–	316	316	–	316
<b>Change in other costs</b>	(1)	70	69	–	69
Asset sales	–	38	38	–	38
Ceased and sold operations	(983)	473	(510)	–	(510)
New and acquired operations	918	(390)	528	–	528
Other	376	(262)	114	–	114
Depreciation, amortisation and impairments	–	(249)	(249)	249	–
Exceptional items	–	(6,206)	(6,206)	6,206	–
<b>Year ended 30 June 2024</b>					
Revenue	55,658				
Other income		1,285			
Expenses excluding net finance costs		(36,750)			
(Loss)/profit from equity accounted investments, related impairments and expenses		(2,656)			
Total other income, expenses excluding net finance costs and (loss)/profit from equity accounted investments, related impairments and expenses		(38,121)			
<b>Profit from operations</b>			17,537		
Depreciation, amortisation and impairments <sup>1</sup>				9,185	
Exceptional item included in Depreciation, amortisation and impairments				(3,800)	
Exceptional items				6,094	
<b>Underlying EBITDA</b>					29,016

1. Depreciation and impairments that we classify as exceptional items are excluded from depreciation, amortisation and impairments. Depreciation, amortisation and impairments includes non-exceptional impairments of US\$90 million (FY2023: US\$75 million).
2. Collectively, we refer to the change in operating cash costs and change in exploration and business development as Change in controllable cash costs. Operating cash costs by definition do not include non-cash costs. The change in operating cash costs also excludes the impact of exchange rates and inflation, changes in fuel, energy costs and consumable costs, changes in exploration and evaluation and business development costs and one-off items. These items are excluded so as to provide a consistent measurement of changes in costs across all segments, based on the factors that are within the control and responsibility of the segment.

## Underlying return on capital employed (ROCE)

	2024	2023	2022
Year ended 30 June	US\$M	US\$M	US\$M
Profit after taxation from Continuing and Discontinued operations	9,601	14,324	33,055
Exceptional items <sup>1</sup>	5,763	606	(7,085)
<b>Subtotal</b>	<b>15,364</b>	<b>14,930</b>	<b>25,970</b>
<i>Adjusted for:</i>			
Net finance costs	1,489	1,531	1,128
Exceptional items included within net finance costs <sup>1</sup>	(506)	(452)	(290)
Income tax expense on net finance costs	(303)	(342)	(287)
<b>Profit after taxation excluding net finance costs and exceptional items</b>	<b>16,044</b>	<b>15,667</b>	<b>26,521</b>
Net assets at the beginning of the period	48,530	48,766	55,605
Net debt at the beginning of the period	11,166	333	4,121
<b>Capital employed at the beginning of the period</b>	<b>59,696</b>	<b>49,099</b>	<b>59,726</b>
Net assets at the end of the period	49,120	48,530	48,766
Net debt at the end of the period	9,120	11,166	333
<b>Capital employed at the end of the period</b>	<b>58,240</b>	<b>59,696</b>	<b>49,099</b>
Average capital employed	58,968	54,398	54,413
<b>Underlying return on capital employed</b>	<b>27.2%</b>	<b>28.8%</b>	<b>48.7%</b>

1. For more information refer to Financial Statements note 3 'Exceptional items'.

## Underlying return on capital employed (ROCE) by segment

Year ended 30 June 2024				Group and unallocated items/eliminations <sup>1</sup>	Total Group
US\$M	Copper	Iron Ore	Coal		
Profit after taxation excluding net finance costs and exceptional items	4,099	11,877	1,254	(1,186)	16,044
Average capital employed	31,205	14,259	6,529	6,975	58,968
<b>Underlying return on capital employed</b>	<b>13%</b>	<b>83%</b>	<b>19%</b>	<b>–</b>	<b>27.2%</b>

Year ended 30 June 2023				Group and unallocated items/eliminations <sup>1</sup>	Total Group
US\$M	Copper	Iron Ore	Coal		
Profit after taxation excluding net finance costs and exceptional items	3,293	10,300	2,970	(896)	15,667
Average capital employed	27,594	15,467	6,281	5,056	54,398
<b>Underlying return on capital employed</b>	<b>12%</b>	<b>67%</b>	<b>47%</b>	<b>–</b>	<b>28.8%</b>

1. Group and unallocated items includes functions, other unallocated operations including Potash, Western Australia Nickel (which comprises the Nickel West operations and, following the OZL acquisition on 2 May 2023, the West Musgrave project), legacy assets and consolidation adjustments.

## Underlying return on capital employed (ROCE) by asset

Year ended 30 June 2024	Western Australia Iron Ore	Antamina	Escondida	BHP Mitsubishi Alliance	Pampa Norte	Copper South Australia <sup>1</sup>	Western Australia Nickel <sup>2</sup>	Potash <sup>3</sup>	New South Wales Energy Coal <sup>4</sup>	Other	Total Group
Profit after taxation excluding net finance costs and exceptional items	11,939	440	2,912	1,038	296	671	(369)	(265)	277	(895)	16,044
Average capital employed	19,732	1,404	10,677	6,731	4,224	14,578	1,269	5,303	(364)	(4,586)	58,968
<b>Underlying return on capital employed</b>	<b>61%</b>	<b>31%</b>	<b>27%</b>	<b>15%</b>	<b>7%</b>	<b>5%</b>	<b>–</b>	<b>–</b>	<b>–</b>	<b>–</b>	<b>27.2%</b>

Year ended 30 June 2023 US\$M	Western Australia Iron Ore	Antamina	Escondida	BHP Mitsubishi Alliance	Pampa Norte	Copper South Australia <sup>1</sup>	Western Australia Nickel <sup>2</sup>	Potash <sup>3</sup>	New South Wales Energy Coal <sup>4</sup>	Other	Total Group
Profit after taxation excluding net finance costs and exceptional items	10,318	426	2,808	1,837	131	166	(51)	(137)	1,212	(1,043)	15,667
Average capital employed	19,420	1,314	10,183	6,672	4,278	11,681	1,635	4,020	(591)	(4,214)	54,398
Underlying return on capital employed	53%	32%	28%	28%	3%	1%	(3%)	—	—	—	28.8%

1. Includes Olympic Dam as well as Prominent Hill and Carrapateena which were acquired on 2 May 2023 as part of the acquisition of OZ Minerals Ltd.
2. Western Australia Nickel comprises the Nickel West operations and, following the OZL acquisition on 2 May 2023, the West Musgrave project. Western Australia Nickel ROCE has not been shown following the Group's decision, announced on 11 July 2024, to temporarily suspend Nickel West operations and the West Musgrave project at Western Australia Nickel.
3. Potash ROCE has not been shown because it is distorted as the asset is non-producing and in its development phase.
4. NSWEC ROCE has not been shown as it is distorted by negative capital employed due to the rehabilitation provision being the primary balance remaining on Balance Sheet following previous impairments.

For personal use only

## Unit costs

Unit costs do not include the re-allocation to assets in FY2024 of the costs associated with the employee entitlements and allowances review conducted in FY2023, which were reported in Group and Unallocated in that period.

The calculation of Escondida, Spence and Copper South Australia unit costs are set out in the tables below.

US\$M	Escondida unit costs		Spence unit costs	
	FY2024	FY2023	FY2024	FY2023
<b>Revenue</b>	<b>10,013</b>	8,847	<b>2,271</b>	2,072
Underlying EBITDA	<b>5,759</b>	4,934	<b>961</b>	767
<b>Gross costs</b>	<b>4,254</b>	3,913	<b>1,310</b>	1,305
Less: by-product credits	<b>523</b>	459	<b>105</b>	137
Less: freight	<b>194</b>	202	<b>49</b>	48
Less: royalties	<b>54</b>	–	<b>–</b>	–
<b>Net costs</b>	<b>3,483</b>	3,252	<b>1,156</b>	1,120
Sales (kt)	<b>1,087</b>	1,051	<b>246</b>	241
Sales (Mlb)	<b>2,396</b>	2,317	<b>543</b>	531
<b>Cost per pound (US\$)<sup>1</sup></b>	<b>1.45</b>	1.40	<b>2.13</b>	2.11

1. FY2024 based on average realised exchange rates of USD/CLP 907 (FY2023 USD/CLP 864).

US\$M	Copper South Australia unit costs
	FY2024
<b>Revenue</b>	<b>4,085</b>
Underlying EBITDA	<b>1,568</b>
<b>Gross costs</b>	<b>2,517</b>
Less: by-product credits	<b>1,354</b>
Less: freight	<b>57</b>
Less: royalties	<b>141</b>
Less: re-allocation of costs associated with the employee entitlements and allowances review	<b>14</b>
<b>Net costs</b>	<b>951</b>
Sales (kt)	<b>314</b>
Sales (Mlb)	<b>692</b>
<b>Cost per pound (US\$)<sup>1,2</sup></b>	<b>1.37</b>

1. FY2024 based on an average realised exchange rate of AUD/USD 0.66.

2. FY2023 comparative is not disclosed as Copper South Australia includes Olympic Dam as well as Prominent Hill and Carrapateena which were acquired on 2 May 2023 as part of the acquisition of OZL which only contributed to the performance of the business from the date of acquisition.

The calculation of WAIO unit costs is set out in the table below.

US\$M	WAIO unit costs	
	FY2024	FY2023
<b>Revenue</b>	<b>27,805</b>	24,678
Underlying EBITDA	<b>18,964</b>	16,660
<b>Gross costs</b>	<b>8,841</b>	8,018
Less: freight	<b>2,182</b>	1,876
Less: royalties	<b>1,954</b>	1,714
Less: re-allocation of costs associated with the employee entitlements and allowances review	<b>48</b>	–
<b>Net costs</b>	<b>4,657</b>	4,428
Sales (kt, equity share)	<b>255,977</b>	248,883
<b>Cost per tonne (US\$)<sup>1</sup></b>	<b>18.19</b>	17.79

1. FY2024 based on an average realised exchange rate of AUD/USD 0.66 (FY2023 AUD/USD 0.67).



The calculation of BMA unit costs is set out in the table below.

US\$M	BMA unit costs	
	FY2024	FY2023
<b>Revenue</b>	<b>5,873</b>	<b>7,652</b>
Underlying EBITDA	<b>1,914</b>	3,197
<b>Gross costs</b>	<b>3,959</b>	<b>4,455</b>
Less: freight	<b>29</b>	32
Less: royalties	<b>1,260</b>	1,667
Less: re-allocation of costs associated with the employee entitlements and allowances review	<b>5</b>	–
<b>Net costs</b>	<b>2,665</b>	<b>2,756</b>
Sales (kt, equity share)	<b>22,294</b>	28,571
<b>Cost per tonne (US\$)<sup>1</sup></b>	<b>119.54</b>	96.46

1. FY2024 based on an average realised exchange rate of AUD/USD 0.66 (FY2023 AUD/USD 0.67).

#### 10.1 Definition and calculation of non-IFRS financial information

Non-IFRS financial information	Reasons why we believe the non-IFRS financial information are useful	Calculation methodology
<b>Underlying attributable profit</b>	Allows the comparability of underlying financial performance by excluding the impacts of exceptional items.	Profit after taxation from Continuing and Discontinued operations attributable to BHP shareholders excluding any exceptional items attributable to BHP shareholders.
<b>Underlying attributable profit – Continuing operations</b>	Allows the comparability of underlying financial performance by excluding the impacts of exceptional items and the contribution of Discontinued operations and is also the basis on which our dividend payout ratio policy is applied.	Underlying attributable profit from Continuing operations also excludes the contribution of Discontinued operations from the above metrics.
<b>Underlying basic earnings per share</b>	On a per share basis, allows the comparability of underlying financial performance by excluding the impacts of exceptional items.	Underlying attributable profit divided by the weighted basic average number of shares.
<b>Underlying basic earnings per share – Continuing operations</b>	On a per share basis, allows the comparability of underlying financial performance by excluding the impacts of exceptional items and the contribution of Discontinued operations.	Underlying attributable profit – Continuing operations divided by the weighted basic average number of shares.
<b>Underlying EBITDA</b>	Used to help assess current operational profitability excluding the impacts of sunk costs (i.e. depreciation from initial investment). Each is a measure that management uses internally to assess the performance of the Group's segments and make decisions on the allocation of resources.	Earnings before net finance costs, depreciation, amortisation and impairments, taxation expense, Discontinued operations and exceptional items. Underlying EBITDA includes BHP's share of profit/(loss) from investments accounted for using the equity method including net finance costs, depreciation, amortisation and impairments and taxation expense/(benefit).
<b>Underlying EBITDA margin</b>		Underlying EBITDA excluding third-party product EBITDA, divided by revenue excluding third-party product revenue.
<b>Underlying EBIT</b>	Used to help assess current operational profitability excluding net finance costs and taxation expense (each of which are managed at the Group level) as well as Discontinued operations and any exceptional items.	Earnings before net finance costs, taxation expense, Discontinued operations and any exceptional items. Underlying EBIT includes BHP's share of profit/(loss) from investments accounted for using the equity method including net finance costs and taxation expense/(benefit).
<b>Profit from operations</b>		Earnings before net finance costs, taxation expense and Discontinued operations. Profit from operations includes Revenue, Other income, Expenses excluding net finance costs and BHP's share of profit/(loss) from investments accounted for using the equity method including net finance costs and taxation expense/(benefit).
<b>Capital and exploration expenditure</b>	Used as part of our Capital Allocation Framework to assess efficient deployment of capital. Represents the total outflows of our operational investing expenditure.	Purchases of property, plant and equipment and exploration and evaluation expenditure including the contribution of Discontinued operations.
<b>Capital and exploration expenditure – Continuing operations</b>	Represents the total outflows of our operational investing expenditure excluding the contribution of Discontinued operations.	Purchases of property, plant and equipment and exploration and evaluation expenditure.

<b>Non-IFRS financial information</b>	<b>Reasons why we believe the non-IFRS financial information are useful</b>	<b>Calculation methodology</b>
<b>Free cash flow</b>	<p>It is a key measure used as part of our Capital Allocation Framework. Reflects our operational cash performance inclusive of investment expenditure, which helps to highlight how much cash was generated in the period to be available for the servicing of debt and distribution to shareholders.</p> <p>Reflects our operational cash performance inclusive of investment expenditure, but excluding the contribution of Discontinued operations.</p>	Net operating cash flows less net investing cash flows.
<b>Free cash flow – Continuing operations</b>		Net operating cash flows from Continuing operations less net investing cash flows from Continuing operations.
<b>Net debt</b>	<p>Net debt shows the position of gross debt less index-linked freight contracts offset by cash immediately available to pay debt if required and any associated derivative financial instruments. Liability associated with index-linked freight contracts, which are required to be remeasured to the prevailing freight index at each reporting date, are excluded from the net debt calculation due to the short-term volatility of the index they relate to not aligning with how the Group uses net debt for decision making in relation to the Capital Allocation Framework. Net debt includes the fair value of derivative financial instruments used to hedge cash and borrowings to reflect the Group's risk management strategy of reducing the volatility of net debt caused by fluctuations in foreign exchange and interest rates.</p>	Interest bearing liabilities less liability associated with index-linked freight contracts less cash and cash equivalents less net cross currency and interest rate swaps less net cash management related instruments for the Group at the reporting date.
<b>Gearing ratio</b>	Net debt, along with the gearing ratio, is used to monitor the Group's capital management by relating net debt relative to equity from shareholders.	Ratio of Net debt to Net debt plus Net assets.
<b>Net operating assets</b>	Enables a clearer view of the assets deployed to generate earnings by highlighting the net operating assets of the business separate from the financing and tax balances. This measure helps provide an indicator of the underlying performance of our assets and enhances comparability between them.	Operating assets net of operating liabilities, including the carrying value of equity accounted investments and predominantly excludes cash balances, loans to associates, interest bearing liabilities, derivatives hedging our net debt, assets held for sale, liabilities directly associated with assets held for sale and tax balances.
<b>Underlying return on capital employed (ROCE)</b>	Indicator of the Group's capital efficiency and is provided on an underlying basis to allow comparability of underlying financial performance by excluding the impacts of exceptional items.	<p>Profit after taxation excluding exceptional items and net finance costs (after taxation) divided by average capital employed.</p> <p>Profit after taxation excluding exceptional items and net finance costs (after taxation) is profit after taxation from Continuing and Discontinued operations excluding exceptional items, net finance costs and the estimated taxation impact of net finance costs. These are annualised for a half year end reporting period.</p> <p>The estimated tax impact is calculated using a prima facie taxation rate on net finance costs (excluding any foreign exchange impact).</p> <p>Average capital employed is calculated as the average of net assets less net debt for the last two reporting periods.</p>
<b>Adjusted effective tax rate</b>	Provides an underlying tax basis to allow comparability of underlying financial performance by excluding the impacts of exceptional items.	Total taxation expense/(benefit) excluding exceptional items and exchange rate movements included in taxation expense/(benefit) divided by Profit from Continuing operations before taxation excluding exceptional items.

For personal use only

Non-IFRS financial information	Reasons why we believe the non-IFRS financial information are useful	Calculation methodology
<p><b>Unit costs</b></p>	<p>Used to assess the controllable financial performance of the Group's assets for each unit of production. Unit costs are adjusted for site specific non-controllable factors to enhance comparability between the Group's assets.</p>	<p>Ratio of net costs of the assets to the equity share of sales tonnage. Net costs is defined as revenue less Underlying EBITDA and excludes freight, re-allocation of the costs associated with the employee entitlements and allowance review in FY2023, and other costs, depending on the nature of each asset. Freight is excluded as the Group believes it provides a similar basis of comparison to our peer group. The re-allocation to assets in FY2024 of the costs associated with the employee entitlements and allowances review in FY2023 are excluded in asset unit costs as these costs were already recognised in Group and Unallocated in FY2023.</p> <p>Escondida, Spence and Copper South Australia unit costs exclude:</p> <ul style="list-style-type: none"> <li>• by-product credits being the favourable impact of by-products (such as gold or silver) to determine the directly attributable costs of copper production</li> <li>• royalties, as these are costs that are not deemed to be under the Group's control and the Group believes exclusion provides a similar basis of comparison to our peer group</li> </ul> <p>WAIO and BMA unit costs exclude:</p> <ul style="list-style-type: none"> <li>• royalties, as these are costs that are not deemed to be under the Group's control and the Group believes exclusion provides a similar basis of comparison to our peer group</li> </ul>

## 10.2 Definition and calculation of principal factors

The method of calculation of the principal factors that affect the period on period movements of Revenue, Profit from operations and Underlying EBITDA are as follows:

<b>Principal factor</b>	<b>Method of calculation</b>
<b>Change in sales prices</b>	Change in average realised price for each operation from the prior period to the current period, multiplied by current period sales volumes.
<b>Price-linked costs</b>	Change in price-linked costs (mainly royalties) for each operation from the prior period to the current period, multiplied by current period sales volumes.
<b>Change in volumes</b>	Change in sales volumes for each operation multiplied by the prior year average realised price less variable unit cost.
<b>Controllable cash costs</b>	Total of operating cash costs and exploration and business development costs.
<b>Operating cash costs</b>	Change in total costs, other than price-linked costs, exchange rates, inflation on costs, fuel, energy and consumable price movements, non-cash costs and one-off items as defined below for each operation from the prior period to the current period.
<b>Exploration and evaluation and business development</b>	Exploration and evaluation and business development expense in the current period minus exploration and business development expense in the prior period.
<b>Exchange rates</b>	Change in exchange rate multiplied by current period local currency revenue and expenses.
<b>Inflation on costs</b>	Change in inflation rate applied to expenses, other than depreciation and amortisation, price-linked costs, exploration and business development expenses, expenses in ceased and sold operations and expenses in new and acquired operations.
<b>Fuel, energy and consumable price movements</b>	Fuel and energy expense and price differences above inflation on consumables in the current period minus fuel and energy expense in the prior period.
<b>Non-cash</b>	Change in net impact of capitalisation and depletion of deferred stripping from the prior period to the current period.
<b>One-off items</b>	Change in costs exceeding a pre-determined threshold associated with an unexpected event that had not occurred in the last two years and is not reasonably likely to occur within the next two years.
<b>Asset sales</b>	Profit/(loss) on the sale of assets or operations in the current period minus profit/(loss) on sale of assets or operations in the prior period.
<b>Ceased and sold operations</b>	Underlying EBITDA for operations that ceased or were sold in the current period minus Underlying EBITDA for operations that ceased or were sold in the prior period.
<b>New and acquired operations</b>	Underlying EBITDA for operations that were acquired in the current period minus Underlying EBITDA for operations that were acquired in the prior period.
<b>Share of profit/(loss) from equity accounted investments</b>	Share of profit/(loss) from equity accounted investments for the current period minus share of profit/(loss) from equity accounted investments in the prior period.
<b>Other</b>	Variances not explained by the above factors.

## **11 Other information**

### **11.1 Company details**

Refer to page i for further information.

### **11.2 Forward-looking statements**

Refer to page i for further information.

This Report is made in accordance with a resolution of the Board.

Ken MacKenzie

Chair

Dated: 27 August 2024

For personal use only

# Corporate Governance Statement

## Contents:

1. Corporate governance at BHP
2. FY2024 corporate governance highlights
3. BHP's governance structure
4. Board composition and succession
5. Board Committees
6. Management
7. Shareholders and reporting
8. Culture and conduct
9. Risk management and assurance
10. US requirements

### 1. Corporate governance at BHP

Good corporate governance underpins the way we conduct business.

This Corporate Governance Statement sets out the corporate governance framework currently in place for the Group, including the key policies and practices.

BHP was fully compliant with the Recommendations of the fourth edition of the ASX Corporate Governance Council's Corporate Governance Principles and Recommendations (ASX Fourth Edition) throughout FY2024. The ASX Fourth Edition is available at [asx.com.au](http://asx.com.au).

BHP is also subject to governance requirements from our London Stock Exchange (LSE) and New York Stock Exchange (NYSE) listings and our registration with the Securities and Exchange Commission (SEC) in the United States.

This Corporate Governance Statement is current as at 27 August 2024 and has been approved by the Board.

More information on our corporate governance framework and practices is available at [bhp.com/governance](http://bhp.com/governance), which includes links to our Appendix 4G and each of the publicly available documents referenced in this Corporate Governance Statement.

### 2. FY2024 corporate governance highlights



#### Our Values

The Board approved the refreshed BHP values which were updated in May 2024. Our Values reflect what we stand for and who we aspire to be.



#### BHP Board updates

Our Board welcomed two new Non-executive Directors, Ross McEwan and Don Lindsay in FY2024, following the retirement of Non-executive Directors Terry Bowen and Ian Cockerill.



#### Investor engagement

We facilitated several investor engagement events and held presentations and briefings on key topics, for example decarbonisation, preparation of our Climate Transition Action Plan 2024 and key ESG themes at our ESG roundtable.



#### Diversity

Our Board continued to be gender balanced in FY2024 (which we define as a minimum 40 per cent women and 40 per cent men in line with the definition used by entities such as the International Labour Organization).

### 3. BHP's governance structure

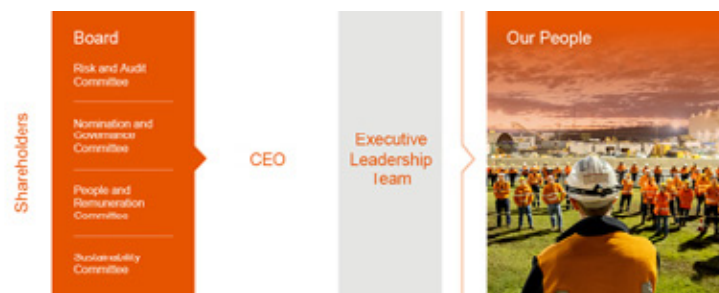

#### Board

The Board has ultimate responsibility for overseeing BHP's governance. The role of the Board, as set out in the Board Governance Document, is to represent shareholders and promote and protect the interests of BHP in the short and long term.

The Board Governance Document outlines the Board's responsibilities and processes, including the matters specifically reserved for the Board, the authority delegated to the Chief Executive Officer (CEO) and the accountability of the CEO for that authority, and provides guidance on the management of the relationship between the Board and the CEO. The Board Governance Document was updated in FY2023 and took effect from 1 July 2023.

The matters reserved for the Board as set out in the revised Board Governance Document include:

- appointing the CEO and determining the terms of the appointment
- approving the appointment of Executive Leadership Team (ELT) members and material changes to the organisational structure involving direct reports to the CEO
- succession planning for the CEO and direct reports to the CEO
- monitoring the performance of the CEO and the Group
- monitoring Board composition, processes and performance
- approving the Group's values, *Our Code of Conduct*, purpose and risk appetite
- establishing, approving and assessing measurable objectives for achieving gender diversity in the composition of the Board, senior executives and workforce generally and assessing the Group's progress in achieving those measurable objectives
- approving strategy, annual budgets, balance sheet management and funding strategy
- approving commitments, capital and non-capital items, acquisitions and divestments above specified limits
- approving the dividend policy and determining dividends
- approving significant social, community and sustainability policies, including those related to climate change and public sustainability goals and targets
- reviewing and monitoring the effectiveness of the Group's systems of principal and emerging financial and non-financial risk management and internal control, and making sure there is an appropriate risk management framework in place
- determining and adopting documents (including the publication of reports and statements to shareholders) that are required by BHP's Constitution, statute or by other external regulation
- determining and approving matters that are required by BHP's Constitution, statute or by other external regulation to be determined or approved by the Board

>[The Board Governance Document is available at bhp.com/governance](https://www.bhp.com/governance)

#### Committees

The Board has established Committees to assist it in exercising its authority, including monitoring the performance of BHP, to gain assurance that progress is being made towards our purpose within the limits delegated by the Board. There are four standing Committees: the Nomination and Governance Committee, Risk and Audit Committee, Sustainability Committee and People and Remuneration Committee.

>[Each Committee is delegated authority by the Board under its Charter. These Charters are available at bhp.com/governance](https://www.bhp.com/governance)

>[For more information on each of the Committees refer to section 5](#)

#### Chair

The Chair is responsible for leading the Board and ensuring it operates to high governance standards. In particular, the Chair facilitates constructive Board relations and the effective contribution of all Non-executive Directors.

## Group Company Secretary

The Group Company Secretary is accountable to the Board and advises the Chair, the Board and individual Directors on all matters of governance process.

## Chief Executive Officer

The CEO is accountable to the Board for the authority that is delegated to the CEO and for the performance of the Group. The CEO works in a constructive partnership with the Board and is required to report regularly to the Board on progress.

## Access to management

The Board has extensive access to members of senior management who frequently attend Board and Committee meetings. Management makes presentations and engages in discussions with Directors, answers questions and provides input and perspective on their areas of responsibility. The Board also engages with members of management at site visits.

The Board also holds discussions in the absence of management as required.

## 4. Board composition and succession

### 4.1 Board of Directors and Company Secretary

The Board currently has 10 members. The Directors' qualifications, experience and special responsibilities are listed below.

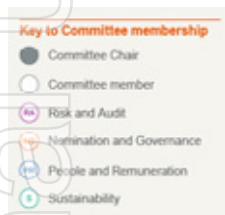

#### Skills and experience

Ken MacKenzie has global executive experience and a deeply strategic approach, with a focus on operational excellence, capital discipline and the creation of long-term shareholder value.

Ken was the Managing Director and Chief Executive Officer of Amcor Limited, a global packaging company with operations in over 40 countries, from 2005 until 2015.

Ken brings business management and leadership skills in global supply chains and governance gained during his career in developed and emerging markets in the Americas, Australia, Asia and Europe. Ken has experience in leading strategic transformation at a business and enterprise-wide level. His commitment to continuous learning and skills development provides valuable insights to Board deliberations and guidance to BHP's leadership team in navigating the fast-changing dynamics of the global economy and markets.

#### Current appointments

Ken is the Chair of Melbourne Business School Limited (since June 2023), sits on the Advisory Board of American Securities Capital Partners LLC (since January 2016), and is a part-time adviser at Barrenjoey (since April 2021).





**Mike Henry**  
**BSc (Chemistry)**

**Appointment**  
 Non-independent Director since January 2020  
 Chief Executive Officer since 1 January 2020

**Skills and experience**

Mike Henry has over 30 years' experience in the global mining and petroleum industry, spanning operational, commercial, safety, technology and marketing roles.

Mike joined BHP in 2003 and has been a member of the Executive Leadership Team since 2011. Prior to joining BHP, Mike worked in the resources industry in Canada, Japan and Australia.

Mike brings deep operational and market knowledge across a range of commodities and a strategic approach to resource and skills development to implement BHP's strategy and future growth options that will support global economic growth and decarbonisation. He is focused on creating a safe, high-performance culture, enabled by an inclusive workplace in which people are empowered at every level through the BHP Operating System.

Mike is committed to building strong relationships with governments, Indigenous partners, community stakeholders and business partners to ensure BHP's activities deliver mutual benefit to these stakeholders while driving strong value for shareholders. Mike brings a disciplined approach to the Board's considerations of capital allocation in assets, technology, commodities and risk management.



**Xiaoqun Clever-Steg**  
**Diploma in Computer Science and International Marketing, MBA**

**Appointment**  
 Independent Non-executive Director since October 2020



**Skills and experience**

Xiaoqun Clever-Steg has over 20 years' experience in technology with a focus on software engineering, data and AI, cybersecurity and digitalisation.

Xiaoqun was formerly Chief Technology Officer of Ringier AG and ProSiebenSat.1 Media SE and Chief Operating Officer of Technology and Innovation at SAP and President of SAP Labs China.

Xiaoqun brings significant expertise in the development, selection and implementation of business transforming technology, innovation and assessment of opportunities and risks in digital disruption. She has knowledge and relationships across the technology and innovation start-up sector across Europe, Asia and North America and brings depth to the Board's review of managing cybersecurity risks as well as assessment of opportunities to invest in proven and emerging technologies in the discovery of new mineral deposits, safer and more cost-effective processing, and technologies to reduce GHG emissions and support the energy transition.

**Current appointments**

Xiaoqun is a Non-executive Director of Amadeus IT Group SA (since June 2020), a Non-executive Director of Straumann Group (since April 2024) and on the Supervisory Board of Infineon Technologies AG (since February 2020).

For persons



**Gary Goldberg**

**BS (Mining Engineering), MBA**

**Appointment**

Independent Non-executive Director since February 2020

Senior Independent Director since 21 December 2020



**Skills and experience**

Gary Goldberg has over 40 years' global executive experience, including deep experience in mining, strategy, risk, commodity value chain, capital allocation discipline and public policy.

Gary was the Chief Executive Officer of Newmont Corporation (from 2013 to 2019), and prior to that, President and Chief Executive Officer of Rio Tinto Minerals. Gary has also been a non-executive Director of Port Waratah Coal Services Limited and Rio Tinto Zimbabwe, and served as Vice Chair of the World Gold Council, Treasurer of the International Council on Mining and Metals, Co-Chair of the World Economic Forum Mining and Metals Industry community and Chair of the National Mining Association in the United States.

Gary is recognised for his leadership in bringing the mining industry together to raise standards in safety and environmental performance in conjunction with community and government partnerships in America and around the world. He has management experience in implementing strategies focused on safety, decarbonisation and transformational investment for commodities with long-dated cycles, along with his contribution to policy development in environmental management globally.

**Current appointments**

Gary is a Director of Imperial Oil Limited (since May 2023).



**Michelle Hinchliffe**

**BCom, FCA, ACA**

**Appointment**

Independent Non-executive Director since March 2022



**Skills and experience**

Michelle Hinchliffe has over 20 years' experience as a partner in KPMG's financial services division.

Michelle was formerly a partner of KPMG and held a number of roles, including as the UK Chair of Audit, a member of the KPMG UK Executive Committee, and led KPMG's financial services practice in Australia and was a member of the KPMG Australia Board.

Michelle has expertise and experience in understanding the complexities of multi-national firms operating in multiple reporting and regulatory frameworks across Europe, the Americas, Asia and Africa. Her financial expertise and audit experience across a range of industries and businesses, including in Australia, bring insights to the Board on BHP's assessment of risk, returns and its long-term capital plan to create financial strength and support BHP's future growth.

**Current appointments**

Michelle is a Non-executive Director of Santander UK plc and Santander UK Group Holdings Plc (since June 2023) and Macquarie Group Limited and Macquarie Bank Limited (since March 2022).



**Don Lindsay**  
**BS (Hons), MBA**

**Appointment**  
 Independent  
 Non-executive Director  
 since May 2024



**Skills and experience**

Don Lindsay has more than 40 years’ global experience, including in mining and resource development, financial markets, transformational leadership, growth and value creation.

Don was the President and Chief Executive Officer of Teck Resources Limited (from 2005 to 2022) and prior to that, worked for almost 20 years with CIBC World Markets Inc., where he served as President, Head of Investment and Corporate Banking and Head of the Asia Pacific Region. Don also served as Chair of the Board of Governors for Mining and Metals for the World Economic Forum, Chair of the Business Council of Canada and Chair of the International Council on Mining and Metals.

Don brings extensive experience in global resource development as well as sustainability, community health, safety and global education and business forums. His technical and management experience across a range of commodities and mining jurisdictions brings a unique understanding of prospective resources, cost of development and operations, and the assessment of opportunities to strengthen the portfolio of world-class assets.

**Current appointments**

Don is Chair of the Board of Manulife Financial Corporation (since February 2023) and the Invictus Games Vancouver Whistler 2025 (since November 2022).



**Ross McEwan**  
**BBus**

**Appointment**  
 Independent  
 Non-executive Director  
 since April 2024



**Skills and experience**

Ross McEwan has over 30 years’ global executive experience, including in the financial services industry, with deep expertise in capital allocation, risk management and value creation in complex regulatory environments.

Ross was the CEO of National Australia Bank (from 2019 to April 2024) and Group CEO of the Royal Bank of Scotland (from 2013 to 2019). Prior to that, he held executive roles at Commonwealth Bank of Australia, First NZ Capital Securities and National Mutual Life Association of Australasia/AXA New Zealand.

Ross brings a strong focus on people and culture, technology and innovation and has extensive experience in capital allocation and value creation. He has worked closely with a wide range of stakeholders, including customers, governments and regulators and brings a global perspective. Ross has a deep understanding of organisational transformation and brings a very strong focus on the customer and technology as a driver of change.

**Current appointments**

Ross is currently on the Board of QinetiQ Group Plc (since March 2024) and Ruminant Biotech Corp Limited (since June 2021).

For personal use



**Christine O'Reilly**

**BBus**

**Appointment**

Independent  
Non-executive Director  
since October 2020



**Skills and experience**

Christine O'Reilly has over 30 years' experience in the financial and infrastructure sectors, with deep financial and public policy expertise and experience in large-scale capital projects and transformational strategy.

Christine was the Chief Executive Officer of the GasNet Australia Group and Co-Head of Unlisted Infrastructure Investments at Colonial First State Global Asset Management, following an early career in investment banking and audit at Price Waterhouse. Christine has also served as a Non-executive Director of Medibank Private Limited (from March 2014 to November 2021), Transurban Group (from April 2012 to October 2020), CSL Limited (from February 2011 to October 2020) and Energy Australia Holdings Limited (from September 2012 to August 2018).

Christine has a deep understanding of financial drivers of the businesses and experience in capital allocation discipline across sectors that have long-dated paybacks for shareholders and stakeholders. Her insights into cost efficiency and cash flow as well as the impact of policy on innovation, investment and project development are key inputs for the Board.

**Current appointments**

Christine is a Non-executive Director of Australia and New Zealand Banking Group (since November 2021), Stockland Limited (since August 2018) and Infrastructure Victoria (since November 2023).

**Skills and experience**

Catherine Tanna has more than 30 years' experience in the resources, oil and gas, power generation and retailing sectors.

Catherine was formerly Managing Director of Energy Australia between 2014 and 2021. Prior to this, she held senior executive roles with Shell and BG Group with responsibility for international operations across Africa, North Asia, Russia, North America, Latin America and Australia. Catherine was also a member of the Board of the Reserve Bank of Australia (from 2011 to 2021) and a Director of the Business Council of Australia (from 2016 to 2021).

Catherine has a track record in leading cultural change and sponsoring gender equity, diversity and inclusion across business and more broadly. She brings an understanding of and contribution to complex regulatory and policy environments. Catherine's experience in seeking to align customer and community expectations, particularly Indigenous communities, with those of the enterprise and regulators, provides unique insight and input to the Board.

**Current appointments**

Catherine is a Non-executive Director at Bechtel Corporation (since May 2023), Chair of Bechtel Australia (since December 2023), Senior Advisor at McKinsey & Company Inc (since April 2022) and a member of the Advisory Board of Fujitsu Australia (since February 2022).

For persons



**Dion Weisler**

**BASc (Computing),  
Honorary Doctor  
of Laws**

**Appointment**

Independent Non-  
executive Director  
since June 2020



**Skills and experience**

Dion Weisler has extensive global executive experience, including transformation and commercial experience in the global information technology sector, with a focus on capital discipline and stakeholder engagement.

Dion was formerly a Director and the President and Chief Executive Officer of HP Inc. (from 2015 to 2019) and continued as a Director and Senior Executive Adviser (until May 2020). He previously held senior executive roles at Lenovo Group Limited, was General Manager Conferencing and Collaboration at Telstra Corporation and held various positions at Acer Inc., including as Managing Director, Acer UK.

Dion brings experience in transforming megatrends into opportunities and growth and valuable insight on the power of innovation, technology and data. His experience also demonstrates insights into strategy development in the global energy transition, where safety, decarbonisation and stakeholder management are critical.

**Current appointments**

Dion is a Non-executive Director of Intel Corporation (since June 2020) and a Non-executive Director of Thermo Fisher Scientific Inc. (since March 2017).



**Stefanie Wilkinson**

**BA, LLB (Hons),  
LLM, FGIA**

**Appointment**

Group Company  
Secretary effective  
March 2021

**Skills and experience**

Stefanie Wilkinson was appointed Group Company Secretary effective March 2021 and Group General Counsel effective 2 April 2024. Prior to joining BHP, Stefanie was a Partner at Herbert Smith Freehills, a firm she was with for 15 years, specialising in corporate law and governance for listed companies. Earlier in her career, Stefanie was a solicitor at Allen & Overy in the Middle East. Stefanie is a fellow of the Governance Institute of Australia.

**4.2 Director independence**

The Board is committed to ensuring that a majority of Directors are independent.

The Board has adopted a policy that it uses to determine the independence of its Directors.

>[The Policy on the Independence of Directors is available at bhp.com/governance](https://www.bhp.com/governance)

**Determination of Director independence**

The Board confirms that it considers all current Non-executive Directors, including the Chair, to be independent of management and free of any interest, position or relationship that might influence, or reasonably be perceived to influence, in a material respect their capacity to bring an independent judgement to bear on issues before the Board and to act in the best interests of BHP as a whole rather than in the interests of an individual security holder or other party.

A determination of independence is carried out upon a Director's appointment and re-election, annually, and when any new interests, positions or relationships are disclosed by a Director. Some Directors hold or have previously held positions in companies that BHP has commercial relationships with.

The Board has assessed the relationships between BHP and the companies in which Directors hold or held positions and has concluded that the relationships do not interfere with the Directors' capacity to bring an independent judgement to bear on issues before the Board, or their ability to act in the best interests of BHP as a whole.

#### **Conflicts of interest**

In accordance with Australian law, if a situation arises for consideration where a Director has a material personal interest, the affected Director takes no part in decision-making unless approval is provided by the non-interested Directors. Provisions for Directors' interests are set out in the Constitution of BHP Group Limited.

### **4.3 Board appointments and succession planning**

BHP adopts a structured and rigorous approach to Board succession planning to guard against the consequences of unforeseen departures and facilitate the orderly replacement of current Directors and oversees the development of a diverse pipeline. This process is continuous, with the aim of allowing the Board to determine an appropriate balance on the Board between experience and fresh perspectives, and the Board continues to be fit for purpose. As part of this process, Ross McEwan was appointed to the Board in April 2024 and Don Lindsay was appointed to the Board in May 2024 following the retirements of independent Non-executive Directors, Terry Bowen in November 2023 and Ian Cockerill in April 2024.

Before the Board formally appoints a person or puts a person forward for election, the Board, with the assistance of external consultants, will conduct appropriate background and reference checks as to that person's character, experience, education and criminal and bankruptcy history.

The Board has adopted a letter of appointment that contains the terms on which Non-executive Directors will be appointed, including the basis upon which they will be indemnified by the Group. The letter of appointment defines the role of Directors, including the expectations in terms of independence, participation, time commitment and continuous improvement. Written agreements are in place for all Non-executive Directors.

### **4.4 Director induction, training and development**

Upon appointment, each new Non-executive Director undertakes an induction program tailored to their needs. Non-executive Directors also undertake an induction program when they join a new Committee, which is tailored to the areas specific to that Committee's role and the Director's previous experience.

Following the induction program, Non-executive Directors participate in continuous improvement activities through a training and development program, which is overseen by the Nomination and Governance Committee to help Directors, individually and collectively, develop and maintain the skills and knowledge to assist them in performing their role effectively. The training and development program is periodically reviewed to maximise effectiveness and to tailor the program to the Directors' needs and the Board's areas of focus.

Throughout the year, the Chair discusses development areas with each Director. Board Committees review and agree their needs for more briefings. The benefit of this approach is that induction and learning opportunities can be tailored to Directors' Committee memberships, as well as the Board's specific areas of focus. This approach is also intended to ensure a coordinated process for succession planning, Board renewal, training and development and Committee composition. In turn, these processes are relevant to the Nomination and Governance Committee's role in identifying appropriate Non-executive Director candidates.

Examples of activities in the training and development program include:

- briefings and development sessions and deep dives to provide each Director with a deeper understanding of the activities, environment, key issues and direction of BHP assets, along with broader sustainability, climate-related, geopolitical and cybersecurity considerations
- training on crisis management
- site visits to provide insights into key issues at BHP's sites and to provide an opportunity for direct engagement with a cross-section of workforce, community members, contractors, Indigenous and First Nations representatives and other stakeholders
- engagement with external experts to discuss views on current and emerging trends and risks (threats and opportunities).

### **4.5 Director skills, experience and attributes**

#### **Overarching statement of Board requirements**

At BHP, we know inclusive and diverse teams are safer and more productive. This is because people in these teams feel safe to speak up, share their ideas and different points of view, and work together to solve problems and make better decisions.

The BHP Board is no different and believes its members should comprise Directors with a broad range of skills and diversity for the Board to:

- provide the breadth and depth of understanding necessary to effectively create long-term shareholder value
- protect and promote the interests of BHP and the creation of social value
- ensure the talent, capability and culture of BHP support the long-term delivery of our strategy

#### **Attributes and commitment to role**

All Directors are expected to comply with *Our Code of Conduct*, act with integrity, lead by example and promote the desired culture.

The Board believes each Non-executive Director has demonstrated the attributes of sufficient time to undertake the responsibilities of the role, honesty and integrity, and a preparedness to question, challenge and critique throughout the year through their participation in Board meetings, and the other activities they have undertaken in their roles.

### Skills matrix

The Board, supported by the Nomination and Governance Committee, reviews the skills and diversity represented by the Directors on the Board and determines whether the composition and mix of those skills remains appropriate to achieve BHP's purpose and strategy.

The Board maintains a skills matrix that identifies the skills and experience the Board needs for the next period of BHP's development, considering BHP's circumstances and the changing external environment.

The Board skills matrix identifies the future-facing skills the Board intends to build, acquire and retain over the medium term in anticipation of its needs as it pursues its strategy of securing growth options in future-facing commodities. The Board skills matrix not only indicates the skills the Board currently possesses, but also provides an illustration of the new skills the Board intends to acquire. An external service provider is engaged to assess the relevant skills and experience of the Directors on the Board set out in the skills matrix.

The Board collectively possesses all the skills and experience set out in the skills matrix, and each Director satisfies the Board requirements and attributes discussed above.

Skills and attributes	Number of Directors
<b>Mining</b> Senior executive who has deep operating or technical mining experience with a large company operating in multiple countries; successfully optimised and led a suite of large, global, complex operating assets that have delivered consistent and sustaining levels of high performance (related to cost, returns and throughput); successfully led exploration projects with proven results and performance; delivered large capital projects that have been successful in terms of performance and returns; and a proven record in terms of health, safety and environmental performance and results.	3
<b>Global experience</b> Global experience gained from working, managing business units and residing in multiple geographies over an extended period of time, including a deep understanding of and experience with global markets, and the geopolitical and economic environment.	9
<b>Strategy</b> Senior executive who has had accountability for enterprise-wide strategy development and implementation in industries with long cycles and developing and leading business transformation strategies.	10
<b>Commodity value chain and customers</b> End-to-end value or commodity chain experience – understanding of consumers and customers, marketing demand drivers (including specific geographic markets) and other aspects of commodity chain development.	8
<b>Financial acumen</b> Extensive financial experience and the capability to evaluate financial statements and understand key financial drivers of the business, bringing a deep understanding of corporate finance and internal financial controls.	10
<b>Operating risk</b> Extensive experience with the development and oversight of complex frameworks focused on the identification, assessment and assurance of operational workplace health, safety, environment, climate and community risks.	9
<b>Technology</b> Recent experience and expertise with the development, selection, and implementation of leading and business transforming technology and innovation and responding to digital disruption.	8
<b>Capital allocation and cost efficiency</b> Extensive direct experience gained through a senior executive role in capital allocation discipline, cost efficiency and cash flow, with proven long-term performance.	8
<b>Social value, community, and stakeholder engagement</b> Extensive track record of positive external stakeholder engagement including in relation to community issues and social responsibility. In-depth understanding of public policy, government relations and the intersection between value generation and corporate reputation.	7
<b>Sustainability and decarbonisation transition</b> Understanding of, and experience with the identification and management of threats and opportunities related to sustainability, and decarbonisation transition.	8
<b>People and talent</b> Extensive experience in talent and capability strategies, including for development, recruitment and retention, and industrial relations, managing workforce transitions and upskilling workforce during periods of rapid change.	8

### 4.6 Diversity

BHP has adopted an Inclusion and Diversity Position Statement, which sets out our diversity policy and our priorities to accelerate the delivery of a more inclusive work environment and to enhance overall workplace diversity.

>[BHP's Inclusion and Diversity Position Statement is available at bhp.com/careers/inclusion-diversity](https://www.bhp.com/careers/inclusion-diversity) and is summarised in OFR 6.6

Our aspiration is to achieve gender balance within our employee workforce globally by CY2025. We define gender balance as a minimum 40 per cent women and 40 per cent men, in line with the definitions used by entities such as the International Labour Organization.

The Board is responsible for approving the measurable objectives for achieving diversity in the composition of the Board, senior executives and workforce generally and assessing the Group's progress in achieving those measurable objectives, which are set out below. The Nomination and Governance Committee reviews and makes recommendations to the Board on the diversity and measurable objectives for achieving diversity in the composition of the Board and reviews the progress in achieving those measurable objectives.

Measurable objective for FY2024	Progress in FY2024
Increase female employee representation to 40 per cent by the end of FY2025	In FY2024, the Board approved the objective to increase the representation of women across the BHP employee workforce by 3 per cent from the FY2023 objective of 35.2 per cent. During FY2024, BHP increased the representation of women working at BHP by 1.9 percentage points, with women now representing 37.1 per cent of the global employee workforce as at 30 June 2024. <sup>1</sup>
Maintain balanced representation for the Board and senior executives (defined as ELT and direct reports to the ELT in grade 15 and above roles)	Our Board continued to be gender balanced in FY2024.  Our senior executive ranks remain consistent and represent 40.9 per cent women in FY2024.

Footnotes:

1. Progress does not include data from the Daunia and Blackwater mines which were divested during the year.

**>For more information on our focus areas for diversity during FY2024 and the respective proportions of men and women on the Board, in senior executive positions and across the employee workforce refer to OFR 6.6**

**>More diversity data is available in the BHP ESG Standards and Databook 2024 available at [bhp.com/ESGStandards2024](https://www.bhp.com/ESGStandards2024)**

The Board's composition reflects gender balance and a diversity of experience, education and geographic background.

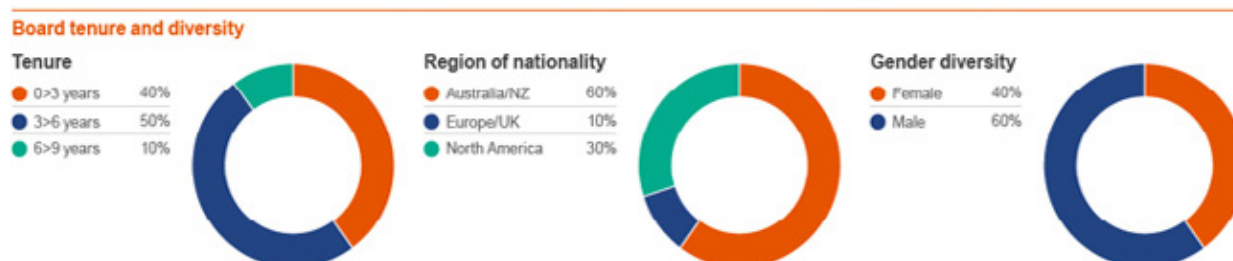

As at 30 June 2024, 40 per cent of Directors are female and the BHP Board satisfies the target in the UK Listing Rules and the guidance of having at least 30 per cent of Directors of each gender in accordance with the ASX Fourth Edition. BHP also satisfies the UK Listing Rule target of having at least one Director from a minority ethnic background on the Board.

BHP does not currently satisfy the UK Listing Rule target that at least one of the senior positions on the Board (which for BHP is the Chair, Chief Executive Officer and Senior Independent Director) is held by a woman. The UK Listing Rule target also includes the Chief Financial Officer in the category of a senior position on the Board. Vandita Pant was appointed as Chief Financial Officer in March 2024, but, in common with Australian listed company practice, the Chief Financial Officer is not a Director on the Board of BHP. As part of its succession planning, the Board reviews the skills and diversity (including gender, age, personal strengths and social and ethnic backgrounds) represented by Directors on the Board and determines whether the composition and mix of those skills and diversity remains appropriate to achieve BHP's purpose and strategy.

The tables in Additional information 7 set out the information required under the UK Listing Rules on diversity as at 30 June 2024. The data presented in these tables was collected by requesting all members of the Board, ELT and Group Company Secretary self-report in questionnaires that include the tables prescribed by the UK Listing Rules.

#### 4.7 Board evaluation

The Board is committed to transparency in assessing the performance of Directors. The Board conducts regular evaluations of its performance, the performance of its Committees, the Group Chair, Directors and the governance processes that support the Board's work.

The evaluation considers the balance of skills, experience, independence and knowledge of the Group on the Board, its diversity and culture, and the operation of governance processes.



In FY2024, an internal evaluation was conducted with the assistance of external service provider, Lintstock. An external Board evaluation is conducted approximately every three years and was last conducted in FY2023.

### **Review of individual Director performance**

The Board has adopted a policy for all Non-executive Directors to seek re-election annually. The Board uses the results of Director performance evaluations in considering whether to nominate a Director for re-election by shareholders. In FY2024, an assessment was conducted of each Director's performance prior to their nomination for re-election with the assistance of external service provider, Lintstock. Lintstock does not have any other connection with the Group or individual Directors.

The assessment of Directors focused on the contribution of each Director to the work of the Board and its Committees, and the expectations of Directors as set out in BHP's governance framework. In addition, the assessment focused on how each Director contributes to Board cohesion and effective relationships with fellow Directors, commits the time required to fulfil their role and effectively performs their responsibilities. Directors were asked to comment on areas where their fellow Directors contribute the greatest value and potential areas for development.

Lintstock provided feedback received to the Chair, which was then discussed with Directors. Feedback relating to the Chair was discussed with the Chair by the Senior Independent Director. As a result of these outcomes, the review supported the Board's decision to recommend each Director standing for re-election.

### **Committee assessments**

Following an assessment of its work, each Committee concluded that it had met the requirements under its Charter in FY2024.

## **5. Board Committees**

The Board has four standing Committees and has delegated a number of duties to each Committee to assist the Board in exercising its responsibilities and discharging its duties. Each Committee's Charter sets out the Committee's roles and responsibilities. These Charters were reviewed and updated in FY2023 as part of the governance review. The aim was to review Board and Committee responsibilities and streamline and modernise the documents in order to best support BHP's strategy and purpose.

**>The updated Charters took effect from 1 July 2023 and are available at [bhp.com/governance](https://www.bhp.com/governance)**

BHP's Board and Committee governance structure facilitates a considered and integrated approach on key matters, for example:

- Climate change is a Board-level issue. The Board is responsible for the governance and oversight of climate change issues, including in relation to our strategic approach, risk management and public disclosures. The Board approves significant social, community and sustainability policies, including those related to climate change and public sustainability goals and targets, and oversees performance against our strategy, goals and targets. The Board is supported by each of its Committees:
  - The Nomination and Governance Committee reviews and makes recommendations to the Board on the Group's significant social, community and sustainability policies, including those related to climate change. The Committee also reviews and makes recommendations to the Board on the Group's public sustainability targets and goals.
  - The Risk and Audit Committee is responsible for assisting the Board in overseeing and reviewing emerging and principal risks facing the Group, including climate risks. The Risk and Audit Committee also reviews and recommends to the Board public financial disclosures regarding sustainability matters.
  - The Sustainability Committee reviews and advises the Board on the adequacy of the Group's governance and performance in relation to climate matters. The Committee also reviews and recommends to the Board disclosures regarding sustainability matters in the Annual Report and other public documents related to the Group's reporting on climate matters.
  - The People and Remuneration Committee is responsible for reviewing and recommending to the Board for approval of performance measures and performance outcomes against those performance measures for the ELT. In doing so, the Committee considers recommendations from the Sustainability Committee in relation to climate measures.
- Sexual harassment is a Board-level issue, supported by the Risk and Audit Committee on the risk and compliance aspects and the Sustainability Committee on the safety, operational aspects and security controls.
- Technology and cyber risk are Board-level issues, supported by the Risk and Audit Committee, which reviews emerging and principal risks facing the Group, including cyber risk.

The Board appoints the members and Chair of each Committee. Only independent Non-executive Directors can be Committee Chairs.

The members and key roles and responsibilities of each Committee are set out below.

**>For Committee attendance and members during FY2024 refer to Directors' Report 2**

## 5.1 Nomination and Governance Committee

### Members

Ken MacKenzie (Chair), Terry Bowen (until 1 November 2023), Gary Goldberg, Michelle Hinchliffe (from 1 November 2023), Christine O'Reilly, Catherine Tanna (from 1 July 2024)

### Key responsibilities/role and focus:

The role of the Nomination and Governance Committee is to support the Board in relation to governance and nomination matters.

The Committee oversees the Group's corporate governance framework and practices, succession planning and processes, Board and Director performance evaluation, Director training and development, and advises and makes recommendations to the Board on the Group's existing corporate governance policies, structures or practices.

The Committee also supports the Board with sustainability-related matters that encompass issues that affect the whole of the Group, including areas of strategy, risk and reporting, people and remuneration by reviewing and recommending to the Board for approval the Group's:

- significant social, community and sustainability policies, including those related to climate change, industry associations and charitable contributions
- public sustainability targets and goals

### Key activities in FY2024:

#### Succession planning processes

- Board and Committee succession
- Identification of suitable Non-executive Director candidates
- Partnering with search firms regarding candidate searches

#### Evaluation and training

- Board evaluation and Director performance evaluation
- Director development program and training
- Assessment of independence of Non-executive Directors

#### Governance practices

- Crisis management
- Review of the Climate Transition Action Plan 2024

## 5.2 Risk and Audit Committee

### Members

Michelle Hinchliffe (Chair since 1 November 2023, and a member of the Committee prior to this date), Terry Bowen (Chair until 1 November 2023), Xiaoqun Clever-Steg, Ian Cockerill (until 4 April 2024), Don Lindsay (from 1 May 2024), Ross McEwan (from 3 April 2024), Christine O'Reilly

### Key responsibilities/role and focus:

The role of the Risk and Audit Committee is to support and advise the Board in relation to financial reporting, external and internal audit, capital management and risk management. The Committee also oversees and assists the Board in reviewing the emerging and principal risks facing the Group, including financial and non-financial risks that could threaten the Group's business model, future performance, solvency, liquidity or reputation.

### US committee membership requirements

The Board is satisfied that Michelle Hinchliffe, who serves as Chair on the Risk and Audit Committee, meets the financial expert requirements under the US Securities and Exchange Commission (SEC) Rules and is independent under applicable NYSE rules. The Board is also satisfied that the Committee meets the independence criteria under Rule 10A-3 of the Exchange Act.

### Key activities in FY2024:

#### Integrity of Financial Statements and funding matters

- Accounting matters for consideration, materiality limits, half-year and full-year results
- Sarbanes-Oxley Act of 2002 (SOX) compliance
- Financial governance procedures
- Funding and guarantee updates
- Samarco dam failure provision, including related provisions and contingent liabilities
- Carrying value of BHP's assets
- Climate-related financial statement and risk disclosures
- Closure and rehabilitation provisions
- Disputes and litigation updates

### **External Auditor and integrity of the audit process**

- Status and results of the external audit
- Management and External Auditor closed sessions
- Audit plan and review of the External Auditor's performance
- External Auditor independence and non-audit services

### **Effectiveness of systems of internal control and risk management**

- Reports on the significant risks facing the Group and the Group's systems of risk management and internal control (including cybersecurity and data privacy)
- Internal audit reports, annual internal audit plan and review of performance of the Internal Audit team
- Reports on sexual harassment, racism and bullying, serious breaches of business conduct, regulatory compliance and grievance and investigation processes
- Reserves and resources updates

## **5.3 Sustainability Committee**

### **Members**

Catherine Tanna (Chair from 1 July 2024), Gary Goldberg (Chair until 1 July 2024), Ian Cockerill (until 4 April 2024), Don Lindsay (from 1 May 2024), Dion Weisler

### **Key responsibilities/role and focus:**

The role of the Sustainability Committee is to support and advise the Board on sustainability matters.

The Committee oversees the Group's health, safety, environment, climate and community performance, including implementation of the Group's strategy, policies and processes in relation to these matters.

The Committee also reviews and advises the Board on the adequacy of the Group's governance of health, safety, environment, climate and community matters, including consideration of emerging areas of risk related to the Group's operations and its engagement with customers, suppliers and communities.

### **Key activities in FY2024:**

#### **Sustainability**

- Operational decarbonisation, water stewardship, cultural heritage and Indigenous engagement, biodiversity, closure and rehabilitation, fatality elimination program and integrated contractor management program updates
- Site visits
- Reports on material health, safety, environment, climate and community risks, including tailings, occupational safety and sexual harassment
- Health, safety and security function plan
- Internal audit reports and annual internal audit plan related to health, safety, environment and community

#### **Disclosure**

- Health, safety and environment compliance updates
- Sustainability disclosures
- Group Modern Slavery Statement
- Disclosures for Global Industry Standard on Tailings Management

#### **Performance**

- Monitor health, safety, environment, climate and community performance, including progress against 2030 goals
- Safety and sustainability measures and performance outcomes for the ELT FY2024 CDP scorecard
- Review health, safety and environment function and performance of the Group Health, Safety and Security Officer

## **5.4 People and Remuneration Committee**

### **Members**

Christine O'Reilly (Chair), Ross McEwan (from 3 April 2024), Catherine Tanna, Dion Weisler

### **Key responsibilities/role and focus:**

The role of the People and Remuneration Committee is to support and advise the Board on people and remuneration matters.

The Committee oversees the Group's key strategies and policies relating to people, including for attraction, recruitment, motivation and retention, employee engagement, leadership and talent development, industrial relations and employee conduct, and monitors the effectiveness of the Group's people and culture strategy and its alignment with the Group's purpose and values.

The Committee oversees and monitors the remuneration framework and practices, including the adoption of incentive plans, levels of reward for the CEO and other ELT members and any major changes in employee benefits structures in the Group.

**>For information on BHP's remuneration practices and policies, including on hedging BHP shares and equity instruments, refer to the Remuneration Report**

## Key activities in FY2024:

### Remuneration

- Executive remuneration strategies
- Group Chair, CEO, ELT members and Group Company Secretary remuneration

### People

- People culture and strategy, people policies and governance, material workforce trends
- Employee engagement, leadership and talent development
- Diversity and inclusion policies and measurable objectives (below Board level)

### Incentive plans

- BHP's employee incentive plans

## 6. Management

Below the level of the Board, key management decisions are made by the CEO, the ELT, management committees and members of management in accordance with their delegated authority.

### 6.1 Executive Leadership Team

	<p><b>Edgar Basto, Chief Operating Officer (BSc, Metallurgy)</b> Edgar Basto joined BHP in 1989 and was appointed Chief Operating Officer in October 2022. Edgar is responsible for Group Health, Safety and Security, the BHP Operating System (BOS) and global Performance and Improvement. Edgar's accountability also includes Copper South Australia and its long-term growth pathway following the recent integration of the former OZ Minerals operations into our business. Edgar has previously held senior roles at BHP, including President Minerals Australia, Asset President of Western Australia Iron Ore and Asset President Escondida (Chile).</p>
	<p><b>Caroline Cox, Chief Legal, Governance and External Affairs Officer (BA (Hons), MA, LLB, BCL)</b> Caroline Cox joined BHP in 2014 and was appointed Chief Legal, Governance and External Affairs Officer in November 2020. Caroline is responsible for Legal, Governance, Ethics and Investigations, Compliance, Global Corporate Affairs and Communications and Sustainability and Social Value. Caroline has previously held senior roles at BHP, including Vice President Legal, Group General Counsel, and Group General Counsel &amp; Company Secretary. Prior to joining BHP, Caroline was a Partner at Herbert Smith Freehills.</p>
	<p><b>Brandon Craig, President Americas (BSc Engineering (Mechanical), MBL)</b> Brandon Craig joined BHP in 1999 and was appointed President of BHP Americas effective 1 March 2024. Brandon is responsible for BHP's copper operations in Chile, joint venture interests in the Americas, and potash operations in Canada. Immediately prior to his appointment as President Americas, Brandon was Asset President for BHP's iron ore business in Western Australia. Brandon's expertise with BHP extends more than 20 years, holding various leadership roles spanning the fields of maintenance, marketing and human resources.</p>
	<p><b>Vandita Pant, Chief Financial Officer (BCom (Hons), MBA)</b> Vandita Pant joined BHP in 2016 and was appointed Chief Financial Officer effective 1 March 2024. Vandita is responsible for overseeing the Group's Reporting, Tax, Treasury, Investor Relations, Financial Planning, Risk and Internal Audit teams. Vandita has previously held senior roles at BHP, including as Chief Commercial Officer from July 2019 to 29 February 2024, Group Treasurer and Head of Europe. Prior to joining BHP, Vandita had more than 20 years' experience in executive banking roles across India, Singapore, Japan and the United Kingdom. Vandita brings strong global financial market, commodity, strategy, capital allocation and business development experience to the role.</p>
	<p><b>Catherine Raw, Chief Development Officer (MA (Cantab.), Natural Sciences, MSc, Mineral Project Appraisal, CFA)</b> Catherine Raw joined BHP on 29 April 2024 as Chief Development Officer. Catherine is responsible for strategy, acquisitions and divestments, securing early-stage growth options and ventures. Prior to joining BHP, Catherine held senior roles in resources and finance industries, including at SSE Thermal (a business unit of SSE plc) as Managing Director, Barrick Gold Corporation as Chief Operating Officer for North America and as Chief Financial Officer, and BlackRock as Managing Director, Natural Resources Team.</p>
	<p><b>Geraldine Slattery, President Australia (BSc, Physics, MSc, International Management)</b> Geraldine Slattery joined BHP in 1994 and was appointed President Australia in October 2022. Geraldine leads BHP's Australian operations in Western Australia, Queensland and New South Wales. Geraldine has previously held senior roles at BHP, including President Petroleum from March 2019 to 31 May 2022. Geraldine has 30 years' experience with BHP, including as President Petroleum, Asset President Conventional and prior to that in several senior operational and business leadership roles across the Petroleum business in the United Kingdom, Australia and the United States.</p>

	<p><b>Ragnar Udd, Chief Commercial Officer (BAppSc (Mining Engineering), MEng, MBA)</b> Rag Udd joined BHP in 1997 and was appointed Chief Commercial Officer effective 1 March 2024. Rag has global accountability for Sales and Marketing, Procurement, Maritime and for developing BHP's views on global commodities markets and macro trends. Rag has over 25 years' experience in the global resources industry, including in Australia, Asia and North and South America. He has held senior roles at BHP in operations, logistics, projects and technology, including President Americas from November 2020 to 29 February 2024, Acting Chief Technology Officer and Asset President of BHP Mitsubishi Alliance.</p>
	<p><b>Johan van Jaarsveld, Chief Technical Officer (BEng (Chem), MCom, Applied Finance, PhD (Eng), Extractive Metallurgy)</b> Johan van Jaarsveld joined BHP in 2016 and was appointed Chief Technical Officer effective 1 March 2024. Johan is responsible for Technology, Minerals Exploration, Innovation and the Centres of Excellence for Projects, Maintenance, Resources and Engineering. Johan has previously held senior executive roles at BHP, including Chief Development Officer from September 2020 to 29 April 2024. Prior to joining BHP, Johan held executive positions in resources and finance, including at Barrick Gold Corporation, Goldman Sachs and The Blackstone Group.</p>
	<p><b>Jad Vodopija, Chief People Officer (BA, PGDip (Industrial Relations and Human Resource Management), MComm)</b> Jad Vodopija rejoined BHP in 2019 and was appointed Chief People Officer in July 2022. Jad is responsible for organisational strategy, talent and resource management, leadership development and workforce performance. Jad has previously held senior roles at BHP, including Vice President, Human Resources. Prior to rejoining BHP, Jad was Vice President Human Resources at Orica from 2016, before which she had built her career at BHP and earlier on at Ford Motor Company.</p>

## 6.2 Senior management succession

A senior management succession process is conducted to support pipeline stability for critical roles. A talent deep dive is conducted by the Board at least once a year to evaluate these pipelines, including the diversity of the pipeline.

Senior management succession is viewed from a five-year perspective that considers the readiness of successors across time horizons, contexts and future capability demands. Select Board members are involved in the interview process for executive-level appointments one level below the CEO and occasionally for roles two levels below the CEO. Appropriate checks are undertaken before appointing a member of the ELT. BHP has a written agreement with each ELT member setting out the terms of their appointment.

In December 2023, BHP announced the following changes to the ELT:

- Vandita Pant was appointed as the Chief Financial Officer, effective 1 March 2024
- Ragnar Udd was appointed as the Chief Commercial Officer, effective 1 March 2024
- Brandon Craig was appointed as the President Americas, effective 1 March 2024
- Johan van Jaarsveld was appointed as the Chief Technical Officer, effective 1 March 2024
- Catherine Raw was appointed as the Chief Development Officer, effective 29 April 2024

Laura Tyler (the former Chief Technical Officer) retired from BHP on 29 February 2024 and David Lamont ceased as Chief Financial Officer on 29 February 2024 and commenced as Senior Executive Officer in an advisory and projects capacity, reporting directly to the CEO until February 2025.

## 6.3 Performance evaluation of executives

The performance of executives and other senior employees is reviewed on an annual basis. The annual performance review process considers the performance of executives against criteria designed to capture 'what' is achieved and 'how' it is achieved. All performance assessments of executives include how effective they have been in undertaking their role and what they have achieved against their specified key performance indicators.

A performance evaluation was conducted for all members of the ELT during FY2024. For the CEO, the performance evaluation was led by the Chair of the Board on behalf of all the Non-executive Directors and was discussed with the People and Remuneration Committee and considered by the Board.

## 7. Shareholders and reporting







### 7.1 Shareholder and stakeholder engagement

#### BHP shareholder engagement practices

BHP engages regularly with our shareholders to understand their views and feedback and we have an investor relations program to provide avenues for effective and timely two-way communication with investors.

We encourage shareholders to make their views known to us. Shareholders can contact us at any time through our Investor Relations team, with contact details available at [bhp.com](http://bhp.com). In addition, shareholders can communicate with us and our registrar electronically.

## Shareholder engagement practices

	<p><u>Direct engagement</u></p> <p>We engage directly with institutional shareholders and investor representative organisations around the world to discuss strategy and governance and to enable our management, Board and Committees to regularly hear investor expectations, which can then be used to refine and develop, and continuously improve, the governance processes of BHP. We also engage directly with retail shareholders and their representatives.</p>
	<p><u>Engagement on key sustainability themes</u></p> <p>In addition to our regular investor meetings program, in FY2024 we held direct engagement sessions with lead investors, including from Climate Action 100+, Nature Action 100 and Principles for Responsible Investment's (PRI) Advance initiative. We also held engagement sessions on preparation of our Climate Transition Action Plan 2024 to obtain feedback from investors on our approach.</p>
	<p><u>Webcasts and Q&amp;A sessions</u></p> <p>We provide webcasts and Q&amp;A sessions as forums to update shareholders on results or other key announcements.</p>
	<p><u>Website</u></p> <p>All relevant corporate governance information, including our Annual Report, is available on our website at <a href="http://bhp.com">bhp.com</a>. All ASX announcements are promptly posted to the website. BHP encourages direct contact from shareholders and our website has a 'Contact Us' form for contact with our Investor Relations team. Anyone who is interested in receiving news from BHP can subscribe to receive email alerts.</p>
	<p><u>Chair and Non-executive Director investor meetings</u></p> <p>The Chair and Senior Independent Director regularly meet with investors to discuss Board priorities and seek shareholder feedback. The People and Remuneration Committee Chair also meets with investors and proxy advisors to discuss remuneration.</p>
	<p><u>Annual General Meeting</u></p> <p>We facilitate and encourage shareholder participation at our Annual General Meeting (AGM). The meeting provides an opportunity for all investors to hear about BHP's performance and to question and engage with the Board and vote on the resolutions. The External Auditor is also available to answer questions at the AGM.</p> <p><b>&gt;Information on our AGM is available at <a href="http://bhp.com/meetings">bhp.com/meetings</a></b></p> <p>Before the AGM, shareholders are provided with all material information in BHP's possession relevant to their decision on whether to elect or re-elect a Director. Copies of the speeches delivered by the Chair and CEO at the AGM are released to the relevant stock exchanges and posted on our website.</p> <p>Proceedings at shareholder meetings are webcast live from our website. Resolutions at general meetings are decided by a poll rather than by a show of hands.</p> <p>A summary of proceedings and the outcome of voting on the items of business are released to the relevant stock exchanges and posted on our website as soon as they are available.</p>

## Stakeholder engagement



The Board considers effective stakeholder engagement a key element of its governance and oversight role. Our strategy, our 2030 goals, our purpose and our Risk Appetite Statement reflect the significance of external partners and stakeholders in decision-making.

There are multiple ways the views of partners and stakeholders, beyond shareholders, are brought to the Board and its Committees.

Examples of reports that are provided to the Board include Employee Perception Survey findings, gender pay gap reports and updates from the CEO and Chief People Officer. In addition, the Risk and Audit Committee and Sustainability Committee receive reports on engagement with regulators. The Risk and Audit Committee receives reports on material litigation and disputes with third parties and misconduct concerns raised through confidential reporting platforms. The Sustainability Committee receives updates on Community Perception Survey findings.

## Stakeholder engagement

	<p><u>Site visits</u></p> <p>Site visits provide an opportunity for Directors to engage directly with the workforce, partners, community members, Indigenous and First Nations representatives and contractors and gain a greater understanding of the Group's operations, culture, material risks and risk management processes, and other issues relevant to the specific site. Site visits in FY2024 included to Nickel West and BMA (November 2023), New South Wales Energy Coal (February 2024), Spence (April 2024) and Jansen (June 2024).</p>
---	---

	<p><u>Workforce</u></p> <p>Directors also have the opportunity to engage directly with a cross-section of the workforce at Board and Committee meetings, at Director briefing sessions and during visits to our sites and offices.</p>
	<p><u>Presentations and briefings</u></p> <p>Presentation materials for briefings and speeches related to financial results, strategy, decarbonisation and other key topics are available at <a href="http://bhp.com">bhp.com</a> for all stakeholders.</p>
	<p><u>Events</u></p> <p>Various events throughout the year, such as retail shareholder events in Australia and the UK and the AGM, provide opportunities for engagement with a range of partners and stakeholders, including government officials, community members, Traditional Owners and other Indigenous partners and non-government organisations.</p>

## 7.2 Market disclosure

BHP is committed to timely and balanced disclosure of market sensitive information.

BHP's Market Disclosure and Communications policy sets out the processes designed to ensure compliance with BHP's relevant disclosure obligations and outlines the way in which information is communicated to shareholders, the investment community and the market. It outlines how we identify and distribute information to shareholders and market participants and sets out the role of the Disclosure Committee in managing compliance with market disclosure obligations.

The Board receives copies of material market announcements promptly after they have been released.

Where BHP gives a new and substantive investor or analyst presentation, it releases a copy of the presentation materials to the market ahead of the presentation.

>**The Market Disclosure and Communications policy is available at [bhp.com/governance](http://bhp.com/governance)**

In addition, we have disclosure controls in place for periodic disclosures, including the Operational Review, our results announcements, debt investor documents (such as the prospectus for the Euro or Australian Medium-Term Notes) and Annual Report documents, which must comply with relevant regulatory requirements.

>**More information about these verification processes can be found in the Disclosure Controls for Periodic Disclosure document available at [bhp.com/governance](http://bhp.com/governance)**

## 8. Culture and conduct

### Code of Conduct

We are committed to the highest level of governance and strive to foster a culture that values and rewards exemplary ethical standards, personal and corporate integrity and respect for others.

The Board, together with management, plays a critical role in setting and reinforcing the culture of the Group.

*Our Code of Conduct* is approved by the Board and is based on Our Values: Do what's right, Seek better ways and Make a difference. It applies to all our Directors, senior executives and employees.

*Our Code of Conduct* includes our policies on speaking up and anti-bribery and corruption, sets out standards of behaviour for our people and is an important statement of the culture at BHP.

>**For more information on our policies on speaking up and our commitment against corruption refer to OFR 6.8**

>**Our Code of Conduct is available at [bhp.com/about/operating-ethically/our-code/](http://bhp.com/about/operating-ethically/our-code/)**

### BHP's channels to raise misconduct concerns

We have mechanisms in place for anyone to raise a query about *Our Code of Conduct* or make a report if they feel *Our Code of Conduct* has been breached. BHP's reporting channels to raise misconduct concerns comprise an online portal and 24-hour multilingual call service. These channels are confidential and accessible to all employees, contractors and external partners and stakeholders, including members of the public, to raise concerns about misconduct that may be unethical, illegal or inconsistent with *Our Code of Conduct*. All misconduct concerns raised through our reporting channels are reviewed and categorised by the Ethics and Investigations team. Once categorised, reports are assigned in accordance with internal policy and processes to an investigator, line leader or appropriate team for resolution. All significant *Our Code of Conduct* matters and key trends from investigations are reported to the Risk and Audit Committee. These are then reported to the Board as part of its report-out process.

>[For more information on ethics and business conduct refer to OFR 6.8](#)

>[More information on ethics and business conduct is available at \[bhp.com/ethics\]\(http://bhp.com/ethics\)](#)

## 9. Risk management and assurance

### 9.1 Risk management governance structure

#### Risk governance

The Risk and Audit Committee (RAC) oversees and assists the Board in risk management and reviewing the emerging and principal risks facing the Group, including financial and non-financial risks that could threaten the Group's business model, future performance, solvency, liquidity or reputation. This includes business risk, financial reporting risk, insurance risk, tax risk, technology security and cyber risk, climate risk and ethical compliance programs. The Board requires the CEO to implement a system of control for identifying and managing risk. The Risk team is accountable for this system, known as BHP's Risk Framework, and also supports, challenges and verifies risk management activities to give assurance to management and the Board. The Directors, with support from the RAC, monitor and, at least annually, will review the effectiveness of the Group's systems of risk management and internal control. The RAC, in undertaking this review, makes a recommendation to the Board on whether the systems of risk management and internal control continue to be sound and whether the Group is operating with due regard to the risk appetite set by the Board.

>[For more information refer to OFR 8](#)

#### Internal audit

The Internal Audit team provides assurance to the Board, CEO and Executive Leadership Team on whether risk management, internal control and governance processes are adequate and functioning. The Internal Audit team is independent of the External Auditor. The RAC evaluates and, if thought fit, approves the Terms of Reference of the Internal Audit team and the annual internal audit plan and monitors the effectiveness of the internal audit activities.

The RAC approves the appointment and dismissal of the Chief Audit Officer (which is currently the Chief Risk and Audit Officer) and assesses their performance, independence and objectivity. During FY2024, the Chief Risk and Audit Officer reported directly to the RAC and functional oversight of the Internal Audit team was provided by the Chief Financial Officer.

#### Effectiveness of systems of internal control and risk management

In delegating authority to the CEO, the Board has established CEO limits, outlined in the Board Governance Document. These limits require the CEO to ensure there is a system of control in place for identifying and managing risk in BHP. Through the RAC, the Directors regularly review these systems for their effectiveness. These reviews include assessing whether processes continue to meet evolving external governance requirements.

The RAC oversees and reviews the internal controls and risk management systems (including procedures, processes and systems for, among other things, financial controls, financial reporting, reporting of reserves and resources, closure and rehabilitation, legal and ethical compliance, preventing fraud and serious breaches of business conduct, speak-up procedures, information technology security and cyber risk). Any material breaches of *Our Code of Conduct*, including breaches of our anti-bribery and corruption requirements and any material incidents reported under our speak-up procedures are reported quarterly to the RAC by the Chief Compliance Officer. These reports are then communicated to the Board through the report-out process.

During FY2024, management presented an assessment of the material risks facing BHP and the effectiveness of the Group's systems of risk management. The reviews were overseen by the RAC, with findings and recommendations reported to the Board. In addition to considering key risks facing BHP, the Board assessed the effectiveness of internal controls over key risks identified through the work of the Board Committees.

Having carried out a review during FY2024, the Board is satisfied with the effectiveness of BHP's risk management and internal control systems.

#### Environmental and social risks

BHP's risk factors (including material exposure to environmental and social risks) and how we manage these risks are described in OFR 8.

### 9.2 External audit and financial reporting

#### Integrity of Financial Statements

The RAC assists the Board in assuring the integrity of the Financial Statements. The RAC evaluates and makes recommendations to the Board about the appropriateness of accounting policies and practices, areas of judgement, compliance with accounting standards, stock exchange and legal requirements and the results of the external audit.



## CEO and CFO assurance

For the FY2024 full year and half year, the CEO and CFO have provided a declaration that in their opinion, BHP's financial records have been properly maintained and those Financial Statements comply with accounting standards and applicable regulatory requirements and give a true and fair view of the financial position and performance of BHP, and that the opinion was formed on the basis of a sound system of risk management and internal control, which is operating effectively. The RAC considered these certifications when recommending the Financial Statements to the Board for approval.

## External Auditor

The RAC manages the relationship with the External Auditor on behalf of the Board. It considers the independence and reappointment of the External Auditor each year, as well as remuneration and other terms of engagement and makes a recommendation to the Board.

## Evaluation of External Auditor and external audit process

The RAC evaluates the objectivity and independence of the External Auditor and the quality and effectiveness of the external audit arrangements, including through:

- reviewing the terms of engagement of the External Auditor
- considering the external audit plan, in particular to gain assurance that it is tailored to reflect changes in circumstances from the prior year and reviewing the plan during the audit engagement
- meeting with the audit partners, particularly the lead audit engagement partners, throughout the year and without management present
- discussing with the audit engagement partners the skills and experience of the broader audit team
- considering the quality of the External Auditor's performance following the completion of the audit

In addition, the RAC reviews the integrity, independence and objectivity of the External Auditor and assesses whether there is any element of the relationship that impairs or appears to impair the External Auditor's judgement or independence. The External Auditor also certifies its independence to the RAC.

## Non-audit services

Although the External Auditor provides some non-audit services to the Group, the objectivity and independence of the External Auditor are safeguarded through restrictions on the provision of these services with some services prohibited from being undertaken.

## Pre-approved services

The RAC has adopted a policy titled Provision of Audit and Other Services by the External Auditor covering the RAC's pre-approval policies and procedures to maintain the independence of the External Auditor.

The categories of 'pre-approved' services are:

- Audit services – work that constitutes the agreed scope of the statutory audit and includes the statutory audits of BHP and its entities (including interim reviews). The RAC monitors the audit services engagements and if necessary, approves any changes in terms and conditions resulting from changes in audit scope, Group structure or other relevant events.
- Audit-related and other assurance services – work that is outside the scope of the statutory audit but is consistent with the role of the external statutory auditor. This category includes work that is reasonably related to the performance of an audit or review and is a logical extension of the audit or review scope, is of an assurance or compliance nature and is work that the external auditors must or are best placed to undertake and is permissible under the relevant applicable standard.
- Tax services – identification of public subsidies and tax incentives and support regarding tax inspections by tax authorities, but only when support from the external auditor or audit firm is required by law.

Activities outside the scope of the categories above are not 'pre-approved' and must be approved by the RAC prior to engagement, regardless of the dollar value involved. In addition, any engagement for other services with a value over US\$250,000, even if listed as a 'pre-approved' service, requires the approval of the RAC.

All engagements for non-audit services, whether 'pre-approved' or not and regardless of the dollar value involved, are reported quarterly to the RAC. While not prohibited by BHP's policy, any proposed engagement of the External Auditor relating to internal control requires specific prior approval from the RAC. In addition, while the categories of 'pre-approved' services include a list of certain pre-approved services, the use of the External Auditor to perform these services will always be subject to our overriding governance practices as articulated in the policy.

In addition, the RAC did not approve any services during the year ended 30 June 2024 pursuant to paragraph (c)(7)(i)(C) of Rule 2-01 of SEC Regulation S-X (provision of services other than audit).

Fees paid to BHP's External Auditor during FY2024 for audit and other services were US\$15.722 million, of which 71 per cent comprised audit fees (including in relation to SOX matters), 12 per cent for audit-related fees and 17 per cent for all other fees. US\$10,000 fees were paid in relation to tax services. For information on the fees paid refer to Financial Statements note 36 'Auditor's remuneration'.

**>Our Provision of Audit and Other Services by the External Auditor policy is available at [bhp.com/governance](https://www.bhp.com/governance)**

## Management's assessment of internal control over financial reporting

Management is responsible for establishing and maintaining adequate internal control over financial reporting (as defined in Rule 13a-15(f) and Rule 15d-15(f) under the Exchange Act).

Because of its inherent limitations, internal control over financial reporting may not prevent or detect misstatements and, even when determined to be effective, can only provide reasonable assurance with respect to financial statement preparation and presentation. Projections of any evaluation of effectiveness to future periods are subject to the risk that controls may become inadequate because of changes in conditions, or the degree of compliance with the policies or procedures may deteriorate.

Under the supervision and with the participation of our management, including our CEO and CFO, the effectiveness of BHP's internal control over financial reporting was evaluated based on the framework and criteria established in Internal Controls – Integrated Framework (2013), issued by the Committee of the Sponsoring Organizations of the Treadway Commission. Based on this evaluation, management concluded that internal control over financial reporting was effective as at 30 June 2024. There were no material weaknesses in BHP's internal controls over financial reporting identified by management as at 30 June 2024.

BHP has engaged independent registered public accounting firm, Ernst & Young, to issue an audit report on the effectiveness of our internal control over financial reporting for inclusion in the Annual Report on Form 20-F as filed with the SEC.

There were no changes in our internal control over financial reporting during FY2024 that materially affected or were reasonably likely to materially affect our internal control over financial reporting.

During FY2024, the RAC reviewed our compliance with the obligations imposed by SOX, including evaluating and documenting internal controls as required by section 404 of SOX.

#### **Management's assessment of disclosure controls and procedures**

Management, with the participation of our CEO and CFO, performed an evaluation of the effectiveness of the design and operation of our disclosure controls and procedures as at 30 June 2024. Disclosure controls and procedures are designed to provide reasonable assurance that the material financial and non-financial information required to be disclosed by BHP, including in the reports it files or submits under the Exchange Act, is recorded, processed, summarised and reported on a timely basis. This information is accumulated and communicated to BHP's management, including our CEO and CFO, as appropriate, to allow timely decisions regarding required disclosure. Based on the evaluation, management (including the CEO and CFO) concluded that as at 30 June 2024, our disclosure controls and procedures are effective in providing that reasonable assurance.

There are inherent limitations to the effectiveness of any system of disclosure controls and procedures, including the possibility of human error and the circumvention or overriding of the controls and procedures. Even effective disclosure controls and procedures can only provide reasonable assurance of achieving their control objectives.

In the design and evaluation of our disclosure controls and procedures, management was required to apply its judgement in evaluating the cost-benefit relationship of possible controls and procedures.

## 10. US requirements

BHP Group Limited is a registrant with the SEC in the United States. It is classified as a foreign private issuer and has American Depositary Shares listed on the New York Stock Exchange (NYSE).

We have reviewed the governance requirements applicable to foreign private issuers under SOX, including the rules promulgated by the SEC and the rules of the NYSE, and are satisfied that we comply with those requirements.

Under NYSE rules, foreign private issuers such as BHP are required to disclose any significant ways our corporate governance practices differ from those followed by US companies under the NYSE corporate governance standards. After a comparison of our corporate governance practices with the requirements of Section 303A of the NYSE-Listed Company Manual followed by US companies, two significant differences were identified:

Rule 10A-3 of the Exchange Act requires NYSE-listed companies to ensure their audit committees are directly responsible for the appointment, compensation, retention and oversight of the work of the External Auditor unless the company's governing law or documents or other home country legal requirements require or permit shareholders to ultimately vote on or approve these matters. Under the terms of our Constitution, our shareholders are ultimately responsible for the appointment and retention of the External Auditor and are required to vote on the appointment of the External Auditor from time to time (as required under Australian law). The RAC remains directly responsible for the compensation and oversight of the work of the External Auditor.

Under Section 303A.08 of the NYSE Listed Company Manual, shareholders must be given the opportunity to vote on all equity-compensation plans and material revisions thereto, with certain exemptions. Under Australian law, BHP Group Limited is not required to provide for shareholder votes on all equity-compensation plans or revisions thereto. Shareholder approval is required for issues of shares to Directors and accordingly is sought only for certain incentive awards to the CEO. The Remuneration Report voted on by shareholders at the Annual General Meeting describes Board and executive remuneration. All incentive programs offered to the Board and/or Executives are intended to comply with our remuneration framework.

We have adopted a Securities Dealing policy and procedures that cover the purchase, sale and other dealings of our securities by Directors, senior management and employees that seek to promote compliance with applicable insider trading laws, rules and regulations.

## Directors' Report

The information presented by the Directors in this Directors' Report relates to BHP Group Limited and its subsidiaries. The Operating and Financial Review (OFR), the Remuneration Report and the 'Lead Auditor's Independence Declaration' are incorporated by reference into and form part of this Directors' Report.

### 1. Review of operations, principal activities and state of affairs

A review of the operations of BHP during FY2024, the results of those operations during FY2024 and the expected results of those operations in future financial years are set out in the OFR 1–7, 9 and 11. Information on the likely developments in BHP's operations in future years and the expected results of those operations also appears in that section.

Our principal activities, including significant changes in the nature of BHP's principal activities during FY2024 are disclosed in the OFR.

There were no significant changes in BHP's state of affairs that occurred during FY2024 and no significant post balance date events other than as disclosed in the OFR and Financial Statements note 35 'Subsequent events'.

No other matter or circumstance has arisen since the end of FY2024 that has significantly affected or is expected to significantly affect the operations, the results of operations or state of affairs of BHP in future years.

### 2. Directors

The Directors who served at any time during FY2024 or up until the date of this Directors' Report are listed in the Board and Board Committee attendance table below. Information on the current Directors, including their terms of service, qualifications, experience and special responsibilities, and directorships of other listed companies held in the last three years, is set out in the Corporate Governance Statement. This information is incorporated by reference into and forms part of this Directors' Report.

#### Director attendances at meetings

The Board meets as often as required. During FY2024, the Board met 16 times.

Members of the Executive Leadership Team and other members of senior management attend meetings of the Board by invitation.

Each Board Committee provides a standing invitation for any Non-executive Director to attend Committee meetings (rather than just limiting attendance to Committee members). Committee agendas and papers are provided to all Directors concerning matters to be considered. The table below excludes the attendance of Directors at Committee meetings where they were not a Committee member.

#### Board and Board Committee attendance in FY2024

	<b>Board Attended/Held</b>	<b>Risk and Audit Committee Attended/Held</b>	<b>Nomination and Governance Committee Attended/Held</b>	<b>People and Remuneration Committee Attended/Held</b>	<b>Sustainability Committee Attended/Held</b>
Terry Bowen <sup>1</sup>	7/7	4/4	3/3		
Xiaoqun Clever-Steg	16/16	8/8			
Ian Cockerill <sup>3</sup>	11/11	8/8			3/3
Gary Goldberg	16/16		6/6		4/4
Mike Henry	16/16				
Michelle Hinchliffe <sup>2</sup>	16/16	8/8	3/3		
Don Lindsay <sup>5</sup>	4/4	1/1			1/1
Ken MacKenzie	16/16		6/6		
Ross McEwan <sup>4</sup>	5/5	1/1		1/1	
Christine O'Reilly	16/16	8/8	6/6	6/6	
Catherine Tanna	16/16			6/6	4/4
Dion Weisler	16/16			6/6	4/4

#### Footnotes

1. Terry Bowen served as a Non-executive Director from 1 October 2017 until his retirement on 1 November 2023 and was a member of the Risk and Audit and Nomination and Governance Committees until 1 November 2023.
2. Michelle Hinchliffe was appointed Chair of the Risk and Audit Committee and a member of the Nomination and Governance Committee from 1 November 2023.
3. Ian Cockerill served as a Non-executive Director from 1 April 2019 until his retirement on 4 April 2024 and was a member of the Risk and Audit and Sustainability Committees until 4 April 2024.
4. Ross McEwan was appointed as a Non-executive Director and a member of the Risk and Audit and People and Remuneration Committees from 3 April 2024.
5. Don Lindsay was appointed as a Non-executive Director and a member of the Risk and Audit and Sustainability Committees from 1 May 2024.

### 3. Share interests

#### Directors' shareholdings

Subject to securities dealing constraints, Non-executive Directors have agreed to apply at least 25 per cent of their remuneration (base fees plus Committee fees) to the purchase of BHP shares until they achieve a minimum shareholding requirement equivalent in value to one year of remuneration (base fees plus Committee fees). Details of Directors' shareholdings in BHP as at the date of this Directors' Report are shown in the table below. All Directors have met the minimum shareholding requirement under their Terms of Appointment as at 30 June 2024, with the exception of Don Lindsay and Ross McEwan who joined the Board on 1 May 2024 and 3 April 2024, respectively. No rights or options over shares in BHP Group Limited are held by any of the Non-executive Directors. We have not made available to any Directors any interest in a registered scheme. No shareholder possesses voting rights that differ from those attaching to all of BHP Group Limited's voting securities.

Director	Number of shares held <sup>1</sup>
Xiaoqun Clever-Steg	8,539
Gary Goldberg	18,000
Mike Henry <sup>2</sup>	410,001
Michelle Hinchliffe	10,107
Don Lindsay	–
Ken MacKenzie	58,446
Ross McEwan	–
Christine O'Reilly	9,420
Catherine Tanna	10,400
Dion Weisler	7,544

1. The number of shares held refers to shares held either directly, indirectly or beneficially by Directors as at 27 August 2024. Where applicable, the information includes shares held in the name of a spouse, superannuation fund, nominee and/or other controlled entities.

2. As at 27 August 2024, Mike Henry also holds 973,178 rights and options over shares in BHP Group Limited. For more information refer to the Equity awards section in the Remuneration Report 5.2.

#### Executive Key Management Personnel

Interests held by members of the Executive Key Management Personnel (KMP) under employee equity plans as at 30 June 2024 are set out in the tables contained in the Equity awards section in the Remuneration Report 5.2.

The table below sets out the relevant interests in shares in BHP Group Limited held directly, indirectly or beneficially, as at the date of this Directors' Report by those senior executives who were Executive KMP (other than the Executive Director) on that date.

Executive KMP member	Number of shares held <sup>1</sup>
Brandon Craig	25,665
Vandita Pant	170,688
Geraldine Slattery	195,011

1. The number of shares held refers to shares held either directly, indirectly or beneficially as at 27 August 2024. Where applicable, the information includes shares held in the name of a spouse, superannuation fund, nominee and/or other controlled entities.

#### 4. Share capital and buy-back programs

During FY2024, we did not make any on-market or off-market purchases of BHP Group Limited ordinary shares under any share buy-back program. As at the date of this Directors' Report, there were no current on-market buy-backs.

Some of our executives receive rights over BHP shares as part of their remuneration arrangements. Entitlements may be satisfied by the transfer of existing shares, which are acquired on-market by the Employee Share Ownership Plan Trusts or, in respect of some entitlements, by the issue of shares. During FY2024, no shares were purchased on-market for the Employee Share Ownership Plan Trusts.

As at the date of this Directors' Report, there were 14,700,777 unvested equity awards outstanding in relation to BHP Group Limited ordinary shares held by 24,462 holders. The expiry dates of these unvested equity awards range between August 2024 and August 2028 and there is no exercise price. 5,710,261 fully paid ordinary shares in BHP Group Limited were issued as a result of the exercise of rights over unissued shares during or since the end of FY2024. No options over unissued shares or unissued interests in BHP have been granted during or since the end of FY2024 and no shares or interests were issued as a result of the exercise of an option over unissued shares or interests during or since the end of FY2024. For more information refer to Financial Statements note 26 'Employee share ownership plans'. For information on movements in share capital during and since the end of FY2024 refer to Financial Statements note 17 'Share capital'.

#### 5. Group Company Secretary

Stefanie Wilkinson is the Group Company Secretary. For details of her qualifications and experience refer to Corporate Governance Statement 4.1. Stefanie Wilkinson has experience in a company secretariat role or other relevant fields arising from time spent advising other large-listed companies or other relevant entities.

#### 6. Indemnities and insurance

Rule 146 of the BHP Group Limited Constitution requires the company to indemnify, to the extent permitted by law, each Officer of BHP Group Limited against liability incurred in or arising out of the conduct of the business of BHP or the discharge of the duties of the Officer. The Directors named in 4.1 of the Corporate Governance Statement, and the Company Secretary and other Officers of BHP Group Limited have the benefit of this requirement, as do individuals who formerly held one of those positions.

In accordance with this requirement, BHP Group Limited has entered into Deeds of Indemnity, Access and Insurance (Deeds of Indemnity) with its Directors.

Under BHP's Deed Poll for Indemnification, BHP Group Limited and BHP Group (UK) Ltd (formerly BHP Group Plc) must, to the extent permitted by law, indemnify current and former employees of the Group against liability to third parties incurred in or arising out of the conduct of the business of the Group or the discharge of the duties of these employees, including where an employee performs a role at another entity at the request of the Group. The indemnity is subject to certain limitations and does not apply where the liability has arisen in circumstances involving dishonesty, recklessness, wilful misconduct or lack of good faith by the employee seeking indemnification.

In addition, as part of the arrangements to effect the demerger of South32, we agreed to indemnify certain former Officers of BHP who transitioned to South32 from certain claims and liabilities incurred in their capacity as Directors or Officers of South32.

The terms of engagement for certain services include that we must compensate and reimburse EY for and protect EY against any loss, damage, expense or liability incurred by EY in respect of third-party claims arising from a breach by BHP of any obligation under the engagement terms.

We have insured against amounts that we may be liable to pay to Directors, Company Secretaries or certain employees (including former Officers) pursuant to Rule 146 of the Constitution of BHP Group Limited or that we otherwise agree to pay by way of indemnity. The insurance policy also insures Directors, Company Secretaries and some employees (including former Officers) against certain liabilities (including legal costs) they may incur in carrying out their duties. For this Directors' and Officers' insurance, we paid premiums of US\$17,535,690 excluding taxes during FY2024.

No indemnity in favour of a current or former Officer of BHP Group Limited or in favour of the External Auditor was called on during FY2024.

#### 7. Dividends

A final dividend of 74 US cents per share will be paid on 3 October 2024, resulting in total cash dividends determined in respect of FY2024 of 146 US cents per share.

**>For information on the dividends paid refer to Financial Statements note 19 'Dividends'**

#### 8. Auditors

No current Officer of BHP has held the role of director or partner of the Group's current External Auditor.

#### 9. Non-audit services

For information on the non-audit services undertaken by BHP's External Auditor, including the amounts paid for non-audit services, refer to Financial Statements note 36 'Auditor's remuneration'. All non-audit services were approved in accordance with the process set out in the Policy on Provision of Audit and Other Services by the External Auditor. No non-audit services were carried out that were specifically excluded by the Policy on Provision of Audit and Other Services by the External Auditor. Based on advice provided by the Risk and Audit Committee, the Directors have formed the view that the provision of non-audit services is compatible with the general standard of independence for auditors, and that the nature of non-audit services means that auditor independence was not compromised. The reason for this view is that the objectivity and independence of the External Auditor are safeguarded through restrictions on the provision of these services with some services prohibited from being undertaken.

**>For more information about our policy in relation to the provision of non-audit services by the external auditor refer to ‘External audit and financial reporting’ in our Corporate Governance Statement 9.2**

## **10. Exploration, research and development**

Companies within the Group carry out exploration and research and development necessary to support their activities.

**>For more information refer to OFR 5 ‘Our assets’, OFR 9 ‘Performance by commodity’ and Additional information 6 ‘Mineral resources and mineral reserves’**

## **11. ASIC Instrument 2016/191**

BHP Group Limited is an entity to which the Australian Securities and Investments Commission (ASIC) Corporations (Rounding in Financial/Directors’ Reports) Instrument 2016/191 applies. Amounts in this Directors’ Report and the Financial Statements, except estimates of future expenditure or where otherwise indicated, have been rounded to the nearest million dollars in accordance with ASIC Instrument 2016/191.

## **12. Proceedings on behalf of BHP Group Limited**

No proceedings have been brought on behalf of BHP Group Limited, nor has any application been made, under section 237 of the Australian Corporations Act 2001.

## **13. Performance in relation to environmental regulation**

BHP seeks to be compliant with all applicable environmental laws and regulations relevant to its operations. We monitor compliance on a regular basis, including through external and internal means, to minimise the risk of non-compliance.

**>For more information on BHP’s performance in relation to health, safety and the environment refer to OFR 6.7, 6.1, 6.9 and 6.10**

For the purposes of section 299(1)(f) of the Australian Corporations Act 2001, in FY2024 BHP was levied nine fines in relation to environmental laws and regulations at our operated assets, the total amount payable being US\$86,850.58.

## **14. Additional information**

- BHP Group Limited has a branch registered in the United Kingdom. The Group, through various subsidiaries, has also established branches in a number of other countries.

The Directors’ Report is approved in accordance with a resolution of the Board.

**Ken MacKenzie**  
Chair  
Dated: 27 August 2024

**Mike Henry**  
Chief Executive Officer

# Remuneration Report

## Contents

<a href="#">People and Remuneration Committee Chair letter to shareholders</a>	148
<a href="#">1. Remuneration governance</a>	151
<a href="#">2. Executive KMP remuneration framework</a>	152
<a href="#">2.1 How the remuneration framework is set</a>	152
<a href="#">2.2 Remuneration framework operation</a>	152
<a href="#">2.3 Remuneration mix</a>	155
<a href="#">3. Remuneration for the CEO and other Executive KMP</a>	155
<a href="#">3.1 FY2024 remuneration received by the CEO</a>	155
<a href="#">3.2 FY2024 CDP performance outcomes</a>	156
<a href="#">3.3 FY2024 LTIP performance outcomes</a>	160
<a href="#">3.4 Overarching discretion and vesting underpin</a>	160
<a href="#">3.5 LTIP allocated during FY2024</a>	161
<a href="#">3.6 FY2025 remuneration for the CEO and other Executive KMP</a>	162
<a href="#">4. Remuneration for Non-executive Directors</a>	162
<a href="#">4.1 Remuneration framework of Non-executive Directors</a>	163
<a href="#">4.2 Non-executive Directors' remuneration in FY2024 and FY2025</a>	163
<a href="#">5. Statutory KMP remuneration and other disclosures</a>	164
<a href="#">5.1 KMP remuneration table</a>	164
<a href="#">5.2 Equity awards</a>	166
<a href="#">5.3 Estimated value range of equity awards</a>	168
<a href="#">5.4 Ordinary shareholdings and transactions</a>	169
<a href="#">5.5 Prohibition on hedging of BHP shares and equity instruments</a>	169
<a href="#">5.6 Share ownership guidelines and the MSR</a>	169
<a href="#">5.7 Transactions with KMP</a>	170

<b>Abbreviation</b>	<b>Item</b>	<b>Abbreviation</b>	<b>Item</b>
AGM	Annual General Meeting	KMP	Key Management Personnel
CDP	Cash and Deferred Plan	LTIP	Long-Term Incentive Plan
CEO	Chief Executive Officer	MAP	Management Award Plan
DEP	Dividend equivalent payment	MSR	Minimum shareholding requirement
ELT	Executive Leadership Team	ROCE	Return on capital employed
GHG	Greenhouse gas	S&S	Safety and sustainability
HSEC	Health, safety, environment and community	TSR	Total shareholder return
IFRS	International Financial Reporting Standards		



## People and Remuneration Committee Chair letter to shareholders

“Our shareholders will see that our executives’ remuneration outcomes are aligned with our business performance during FY2024.”

Dear Shareholders,

I am pleased to provide BHP’s Remuneration Report for FY2024.

### Our approach and framework

During FY2024, the People and Remuneration Committee (**Committee**) focused on achieving remuneration outcomes that both fairly reflect the performance of BHP and the contribution of our employees while aligning with the interests of shareholders and other key stakeholders.

The objectives of our remuneration framework are to support the execution of the Group’s global strategy, encourage and sustain a culture aligned with the Group’s values and BHP’s purpose and risk appetite, and provide competitive remuneration, linked to performance, sufficient to attract, retain and motivate our executives on a global basis. This is critical to delivering the best outcomes for all BHP shareholders.

### FY2024 reflections

We delivered strong operational and financial performance in FY2024. We achieved record production at Spence, Carrapateena and Western Australia Iron Ore and widened our lead as the lowest cost major iron ore producer.

The safety of our people remains our absolute priority. FY2024 was overshadowed by the fatality of Luke O’Brien, a team member working with one of our contracting partners at BMA, who was fatally injured at the Saraji mine in Queensland. We remain committed to eliminating fatalities and serious injuries at BHP. In a year where we have reported a fatality, it is important this has a flow-on impact on our performance-based remuneration framework outcomes for BHP executives, which reinforces our unwavering commitment to zero fatalities and serious injuries at BHP. Appropriately, there has been an impact on remuneration outcomes from this event.

We continued to make meaningful progress towards a more inclusive and diverse workforce, which is critical for productive and safer teams. We increased female participation across the Group to over 37 per cent, up almost 2 percentage points from last year.

In FY2023 we identified and disclosed two issues with certain allowances and entitlements affecting some current and former employees in Australia. We self-reported these issues to Australia’s Fair Work Ombudsman (**FWO**) and engaged Protiviti, a global assurance firm, to undertake a review of our payroll systems. The Board and CEO have taken these issues seriously. A range of consequences have been implemented for employees in connection with these issues. For the CEO, a reduction has been applied to his FY2024 CDP outcome (refer further below).

### FY2024 Cash and Deferred Plan scorecard

BHP’s Cash and Deferred Plan (**CDP**) is an annual cash and equity incentive scheme, with awards provided as cash and deferred shares that vest in two and five years. The FY2024 CDP scorecard used to assess the CEO’s and other ELT members’ annual performance comprised stretching performance measures based on three elements – safety and sustainability, financial and personal performance elements. A key aspect of the CDP is that vesting of the five-year deferred share awards is underpinned by a holistic review of performance at the end of the five-year vesting period, including a review of safety and sustainability performance over the five-year period.

Climate change CDP measures also play a meaningful role in the determination of our remuneration outcomes for our CEO and other ELT members. Each year since FY2020, climate change scorecard targets have represented 10 per cent in BHP’s CDP scorecard. Our Climate Transition Action Plan (**CTAP**) 2024 provides an update on our climate strategy and our progress and plan in relation to our GHG emissions goals and targets.

### FY2024 Cash and Deferred Plan outcomes for the CEO

The Committee assessed the CEO’s performance against the CDP scorecard elements, which resulted in a FY2024 CDP outcome of 71.7 per cent against a target of 100 per cent (and 47.8 per cent of the maximum). The Board and Committee believe this overall outcome is appropriately aligned with BHP’s values, the shareholder experience and the interests of the Group’s other key stakeholders.

Safety and sustainability measures have a 25 per cent total weighting. There is a 10 per cent measure for significant HSEC events. The outcome took into account the fatality at the Saraji mine in FY2024 and the 10 per cent measure for significant HSEC events was reduced to zero in FY2024 for the CEO. For other sustainability measures, good progress was made against the scorecard’s climate change targets and our outcomes with respect to Indigenous partnerships was broadly aligned to target. As a result, the CDP scorecard assessment for the safety and sustainability measures overall was 15 per cent out of a target of 25 per cent.

For the financial measures, after fully eliminating the impacts of commodity prices during the year, operating performance at our operated assets was below the challenging internal targets set at the commencement of the year, particularly with respect to production volumes, despite achieving record production at some assets. The CDP scorecard assessment for the financial measure was 37 per cent out of a target of 50 per cent.

From a personal contribution perspective, the Committee considered Mike Henry's performance against his Group measures. These included projects and initiatives in respect of people, performance and portfolio. The Committee considered Mike's performance against his Group objectives was slightly below expectations and assessed it as 24 per cent against the target of 25 per cent.

This assessment against scorecard objectives gave an FY2024 CDP outcome for Mike of 76 per cent based on performance during the year. Subsequent to this assessment, the Board also took into account the CEO's ultimate accountability for the operations of BHP, specifically payroll issues, and made the decision to reduce Mike's overall FY2024 outcome by 4.3 percentage points from 76 per cent to 71.7 per cent.

The CDP scorecard outcomes for other ELT members and the short-term incentive pool applicable to the majority of BHP employees below the ELT level, were, like the CEO, below the 100 per cent target and, for certain executives, the CDP scorecard outcomes included downward adjustments reflecting accountability for BHP's payroll issues.

### 2019 Long-Term Incentive Plan award

The vesting outcome for the 2019 Long-Term Incentive Plan (LTIP) award was 50 per cent. The LTIP performance condition is relative total shareholder return against two separate index measures – a sector peer group and the MSCI World Index. BHP outperformed both the sector peer group and the MSCI World Index requirements for threshold vesting (at which 25 per cent of the award would vest) but performance was below the requirements for maximum vesting (at which 100 per cent of the award would vest).

In considering vesting of the 2019 LTIP award, the Board and Committee have also conducted their normal holistic review of business performance over the five years since the award was granted to ensure this level of vesting was appropriate. More information on the 2019 LTIP vesting outcome is included in 3.3 FY2024 LTIP performance outcomes and 3.4 Overarching discretion and vesting underpin.

Having considered the overall remuneration outcome for the CEO carefully, the Committee concluded it was a fair reflection of performance and the experience of shareholders, and the application of any downwards discretion to the vesting of the LTIP was not warranted. More information on the overall remuneration outcomes for the CEO for the year, and how the outcomes are aligned to performance during FY2024, is provided in 3.1 FY2024 remuneration received by the CEO.

### FY2025 remuneration

For FY2025, the Committee determined that the CEO's base salary would increase by 4 per cent, effective 1 September 2024. In making this decision, we have conducted benchmarking and considered the external market demand for global senior executive talent. We benchmark the CEO's and other executives' remuneration against CEO and senior executive roles in other global companies of similar complexity, reach and scale. This detailed benchmarking is intended to ensure BHP's executive remuneration remains competitive to attract, motivate and retain key talented senior executives and is consistent with the global market.

The Committee considers the CEO's base salary increase to be appropriate in this context, and it is below the average salary increase applied for other BHP employees. Other components of the CEO's total target remuneration (pension contributions, benefits, CDP and LTIP) remain unchanged and, where relevant, as percentages of base salary. A summary of the CEO's arrangements for FY2025 is set out in the following table.

CEO FY2025 fixed remuneration	CEO FY2025 CDP	CEO FY2025 LTIP
<ul style="list-style-type: none"> <li>Base salary US\$1.893 million per annum, an increase of 4% from 1 September 2024.</li> <li>Pension contribution 10% of base salary.</li> </ul>	<ul style="list-style-type: none"> <li>Target cash award of 80% of base salary (maximum 120%).</li> <li>Two awards of deferred shares each of equivalent value to the cash award, vesting in two and five years, respectively.</li> <li>Three performance measures: <ul style="list-style-type: none"> <li>S&amp;S – 25%</li> <li>Financial – 50%</li> <li>Group – 25%</li> </ul> </li> </ul>	<ul style="list-style-type: none"> <li>The LTIP grant is based on a face value of 200% of base salary.</li> <li>LTIP awards have challenging relative TSR performance hurdles measured over five years.</li> </ul>

The majority of the CEO's remuneration package continues to be delivered in BHP equity, not in cash. The CEO's remuneration is linked to the performance of the business. In addition, the CEO has a minimum shareholding requirement of five times pre-tax base salary and this applies for two years post-retirement. This ensures the CEO's remuneration is aligned to the experience of BHP's shareholders. As at the date of this Report, the CEO's BHP shareholding is in excess of his minimum shareholding requirement.

The Committee has also reviewed the base salaries and total target remuneration packages for other executive key management personnel. The Committee determined an increase of 8 per cent for the President Australia, reflecting performance and development in role. Given recent appointments, no other changes are being made for other executive key management personnel at this time, and this will be the subject of future reviews. It is vital that we provide competitive remuneration to attract and retain highly skilled global executive talent and our reviews are based on updated global benchmarking data. Other aspects of other executive key management personnel remuneration arrangements remain unchanged.

### **Remuneration outcomes for the Group Chair and Non-executive Directors**

Fees for the Group Chair and Non-executive Directors are reviewed annually and are benchmarked against global companies of similar complexity, reach and scale. Following an assessment of the updated benchmarking, global market positioning and peer company relativities, a decision has been made that the Group Chair's fee and the Non-executive Directors' base fee will increase by 4 per cent with effect from 1 July 2024. The increases are considered appropriate given current benchmarking and the expectations, accountabilities and workloads of each of the Group Chair and Non-executive Directors. Having conducted this review, it was determined that there would be no change to the fees for other Committee roles or other allowances.

### **People**

From 1 July 2023, the remit of the Committee expanded to include oversight of BHP's people and culture strategy, the organisation's alignment with the Group's purpose and values, employee engagement, leadership and talent development.

During the year, we engaged with management on our people policies and governance, performance management system and the launch and embedment of Our refreshed Values. Committee members also monitored culture through Board visits to our sites and offices, management presentations and by considering trends and results from our Engagement and Perception Surveys. Our aspiration to achieve gender balance within our employee workforce globally by the end of CY2025 remains a key aspect of our broader focus on diversity and inclusion.

### **Summary**

We continue to provide a significant component of executive remuneration as at-risk variable remuneration to align remuneration with performance. This year, we are confident the outcomes are consistent with the performance of BHP and the experience of our shareholders, while also recognising our critical need to attract, motivate and retain our executives in order to progress our strategic objectives and deliver the best outcomes for all of our shareholders.

We look forward to ongoing dialogue with and the support of BHP's shareholders. As always, we welcome your feedback and comments on any aspect of this Report.

### **Christine O'Reilly**

Chair, People and Remuneration Committee

27 August 2024

## Remuneration governance

### 1.1 Board oversight

The Board oversees the structure of remuneration for the Group (including the CEO) and ensures it is aligned with BHP's values, purpose, strategy and risk appetite including in relation to non-financial risk and with the long-term interests of BHP and its shareholders.

The Board approves the remuneration framework for the Group Chair, CEO and other members of the ELT on recommendation from the Committee. The remuneration of Non-executive Directors (excluding the Group Chair) is a matter for the Group Chair and the Executive Director, and is reviewed by them each year having regard to the remuneration framework. No Director or executive is involved in deciding their own remuneration.

The objective of the remuneration framework is to:

- support the execution of the Group's business strategy
- encourage and sustain a culture aligned to BHP's values, purpose and risk appetite, including in relation to non-financial risk
- provide competitive remuneration, which is linked to performance, to attract, motivate and retain highly skilled executives on a global basis

The Board approves the remuneration arrangements and outcomes for the Group Chair and CEO on recommendation from the Committee.

### 1.2 People and Remuneration Committee

The Board has established the Committee to support and advise the Board on people and remuneration matters, as set out in the Committee Charter available at [bhp.com](http://bhp.com). Each of the Committee members are independent Non-executive Directors. The current members of the Committee are Christine O'Reilly (Chair), Ross McEwan, Catherine Tanna and Dion Weisler.

The Committee has unrestricted access to members of senior management as appropriate and invites them to attend meetings to provide reports and updates. However, members of management are not present when decisions are considered or taken concerning their own remuneration. The Committee can also draw on services from a range of external sources, including independent remuneration advisers. The Committee also receives input from other Board committees as required, in relation to financial performance and safety and sustainability matters.

The Committee makes recommendations to the Board on the remuneration framework for the Group Chair, the CEO and other members of the ELT, including Executive KMP. The Committee is briefed on and considers prevailing market and economic conditions where our Executive KMP are based, the competitive environment and the positioning and relativities of pay and employment conditions across the wider BHP workforce.

From 1 July 2023, the remit of the Committee expanded to include oversight of BHP's people and culture strategy, the organisation's alignment with the Group's purpose and values, employee engagement, leadership and talent development. More information on the role and focus of the Committee can be found in Corporate Governance Statement 5.4, and details of meeting attendances can be found in Directors' Report 2.

The Committee's approach is that remuneration outcomes, which are linked to performance, attract, motivate and retain highly skilled executives on a global basis. Remuneration should be fair to the individual and remuneration levels should accurately reflect the CEO's and other Executive KMP's responsibilities and contributions, while considering the positioning and relativities of pay and employment conditions across the wider BHP workforce.

The Committee also considers shareholder views and those of the wider community when setting this remuneration framework. We proactively engage with our global institutional and investor representative shareholders regularly to discuss remuneration and governance matters. This feedback assists Directors to have a deep understanding of current shareholder and other stakeholder views when making remuneration decisions.

### 1.3 Engagement of independent remuneration advisers

The Committee may appoint and instruct expert advisers who are advisers solely to the Committee, including remuneration consultants, to assist the Committee with advice in relation to the Group's remuneration strategy, framework and policies. The Committee may meet with external advisers without management being present. Potential conflicts of interest are taken into account when remuneration consultants are selected and their terms of engagement regulate their level of access to, and require their independence from, BHP's management.

PwC was appointed to act as an independent remuneration adviser in FY2016 and is currently the only remuneration adviser appointed by the Committee. In that capacity, PwC may provide remuneration recommendations in relation to KMP, however, it did not provide any remuneration recommendations in FY2024.

## 1.4 Service contracts

The terms of employment for the CEO and Executive KMP are formalised in their employment contracts. The current contracts of the CEO and Executive KMP are not fixed term. BHP may choose to terminate a contract on up to 12 months' notice. BHP can require an executive to work through the notice period or may terminate the individual's contract immediately by paying base salary plus pension contributions in lieu of the notice period. The CEO and Executive KMP must provide up to 12 months' notice for voluntary resignation.

## 1.5 KMP for FY2024

This Remuneration Report describes the remuneration policies, practices, outcomes and governance for the KMP of BHP during FY2024. At BHP, KMP consists of the Directors (including the CEO), as well as certain members of our ELT who have authority and responsibility for planning, directing and controlling the activities of the Group directly or indirectly. In FY2024, Brandon Craig and Vandita Pant moved into new KMP roles within the BHP Group, and David Lamont and Ragnar Udd moved into new non-KMP roles within the BHP Group, all effective 1 March 2024. After due consideration, the Committee determined the Chief Operating Officer was no longer a KMP role effective 1 March 2024 as, since the successful integration of OZ Minerals into the BHP Group, the role no longer meets the threshold necessary for classification as KMP. Accordingly, for FY2024, the KMP comprised the following individuals:

- Mike Henry, CEO and Executive Director
- Edgar Basto, Chief Operating Officer (from 1 July 2023 to 29 February 2024)
- Brandon Craig, President Americas (from 1 March 2024 to 30 June 2024)
- David Lamont, Chief Financial Officer (from 1 July 2023 to 29 February 2024)
- Vandita Pant, Chief Financial Officer (from 1 March 2024 to 30 June 2024)
- Geraldine Slattery, President Australia
- Ragnar Udd, President Americas (from 1 July 2023 to 29 February 2024)
- All Non-executive Directors – for details of Non-executive Directors, including dates of appointment or cessation (where relevant), refer to Directors' Report 2

These individuals have held their positions and were KMP for the whole of FY2024, unless stated otherwise.

## 2 Executive KMP remuneration framework

BHP has an overarching remuneration framework for Executive KMP that guides the Committee's decisions and is designed to support our strategy and reinforce our culture and values.

### 2.1 How the remuneration framework is set

The four principles that underpin the remuneration framework for Executive KMP are:



### 2.2 Remuneration framework operation

These principles are the same as those that apply to other employees, however, Executive KMP arrangements have a greater emphasis on and a higher proportion of remuneration that is at-risk as performance-related variable pay.

The table below shows the key components of our remuneration framework:

	<u>Fixed remuneration</u>	<u>CDP</u>	<u>LTIP</u>
<b>Purpose and link to strategy</b>	Market competitive fixed remuneration is paid to attract, motivate and retain high-quality and experienced executives, and provide appropriate remuneration for these important roles in the Group.	The CDP is an annual cash and equity award that encourages and focuses executives' efforts for the relevant financial year on the delivery of the Group's strategic priorities, balancing financial and non-financial performance, to deliver short-, medium- and long-term success aligned to our purpose and Our Values, and to motivate executives to strive to achieve stretch performance objectives.	The LTIP is a long-term equity award that focuses executives' efforts on the achievement of sustainable long-term value creation and success of the Group (including appropriate management of business risks).
<b>Components</b>	Base salary, pension contributions and benefits.	Cash and deferred shares.	Performance rights.
<b>Approach and link to performance</b>	Competitive fixed remuneration is aligned to global complexity, reach and scale, and reflects executives' responsibilities, location, skills, performance, qualifications and experience.	Annual variable pay opportunity provided in cash and two- and five-year deferred shares with the outcome determined by the assessment of performance against a balanced scorecard linked to execution of business strategy. A balanced scorecard of short-, medium- and long-term elements including S&S (25% weighting), financial (50% weighting) and Group and individual performance measures (25% weighting) are chosen on the basis that they are expected to have a significant short-, medium- and long-term impact on the success of the Group, with appropriate targets for each measure that will appropriately motivate executives to achieve outperformance that contributes to the long-term sustainability of the Group and shareholder wealth creation.	Annual long-term variable pay opportunity allocated as awards of performance rights, which are subject to a five-year relative TSR performance condition. The performance rights are designed to align executives' reward with sustained shareholder wealth creation in excess of relevant comparator group(s), through the relative TSR performance condition. Relative TSR has been chosen as an appropriate measure as it enables an objective external assessment over a sustained period on a basis that is familiar to shareholders.

For personal use only

**CDP**

**Assessment of performance**

A CDP award is determined based on the assessment of each scorecard measure by the Committee and the Board, with guidance provided by other relevant Board Committees (including the Sustainability Committee and Risk and Audit Committee) in respect of S&S, financial and other measures.

If performance is below the threshold level for any measure, no CDP award will be provided in respect of that portion of the CDP award opportunity.

The Committee retains discretion to adjust all or part of any CDP award in the event the Committee does not consider the outcomes to be a true reflection of the performance of the Group or considers that individual performance or other circumstances makes this an inappropriate outcome. This mitigates the risk of unintended award outcomes.

**Delivery and vesting**

CDP awards are provided as cash and two awards of deferred shares, each of equivalent value to the cash award, vesting in two and five years, respectively.

Awards of deferred shares comprise rights to receive ordinary BHP shares at the end of the deferral periods subject to continued employment with BHP until the vesting date. Before the awards vest, these rights are not ordinary shares and do not carry entitlements to ordinary dividends or other shareholder rights, however, a DEP is provided on vested awards. The Committee also has a discretion to settle CDP deferred shares in cash.

Vesting of five-year deferred shares under the CDP is underpinned by a holistic review of performance at the end of the five-year vesting period, including a review of S&S performance, profitability, cash flow, balance sheet health, returns to shareholders, corporate governance and conduct over the five-year period.

**LTIP**

Vesting of the LTIP award is dependent on BHP's TSR relative to the TSR of relevant comparator group(s) over a five-year performance period.

Achievement against each TSR hurdle is assessed by the Committee and the Board, based on external data reviewed and confirmed by independent remuneration consultants.

<b>BHP's TSR performance</b>	<b>% of the LTIP award that will vest</b>
• Below the 50 <sup>th</sup> percentile	0%
• Equal to the 50 <sup>th</sup> percentile	25%
• Between the 50 <sup>th</sup> percentile and the weighted 80 <sup>th</sup> percentile	Sliding scale between 25% and 100%
• Equal to, or exceeds, the 80 <sup>th</sup> percentile (outperformance)	100%

Where the TSR performance condition is not met, there is no retesting and awards will lapse.

The Committee retains discretion to lapse any portion or all of the award where it considers the vesting outcome is not appropriate given Group or individual performance, or other circumstances apply that makes the vesting outcome an inappropriate outcome. This mitigates the risk of unintended outcomes.

LTIP awards consist of rights to receive ordinary BHP shares in the future if the performance and service conditions are met.

Before vesting, these rights are not ordinary shares and do not carry entitlements to ordinary dividends or other shareholder rights, however, a DEP is provided on vested awards. The Committee has a discretion to settle LTIP awards in cash.

Vesting of five-year performance rights under the LTIP is underpinned by a holistic review of performance at the end of the five-year performance period, including a review of S&S performance, profitability, cash flow, balance sheet health, returns to shareholders, corporate governance and conduct over the five-year period.

## CDP

## LTIP

### Cessation of employment

On cessation of employment, a 'good leaver'<sup>1</sup> may receive a pro-rated cash award based on performance for that year. For a 'good leaver', their unvested CDP deferred awards generally remain on foot (wholly or in part) unless the Committee determines otherwise. If the executive is not a 'good leaver', all unvested CDP deferred awards will lapse.

On cessation of employment, for a 'good leaver'<sup>1</sup> their unvested LTIP awards generally remain on foot and are pro-rated for the portion of the vesting period served, unless the Committee determines otherwise. These awards are eligible for vesting in the ordinary course, subject to any applicable performance conditions. If the executive is not a 'good leaver', all unvested LTIP awards will lapse.

### Malus and clawback

In certain circumstances, including to prevent an executive obtaining an inappropriate benefit, the Committee may determine that some or all awards (including equity, cash and deferred share awards) are lapsed, forfeited or clawed back. The Committee may also suspend or delay vesting of awards if an investigation is underway, until the outcome of any investigation is known. BHP also has a Malus and Clawback Policy that applies to all equity awards.

<sup>1</sup> 'Good leaver' treatment may apply where the reason for the cessation of employment with BHP is due to retirement, retrenchment or redundancy, termination by mutual agreement or such other circumstances that do not constitute resignation or termination for cause.

## 2.3 Remuneration mix

The diagram below provides the scenarios for the potential total remuneration of the CEO and other Executive KMP at different levels of performance.

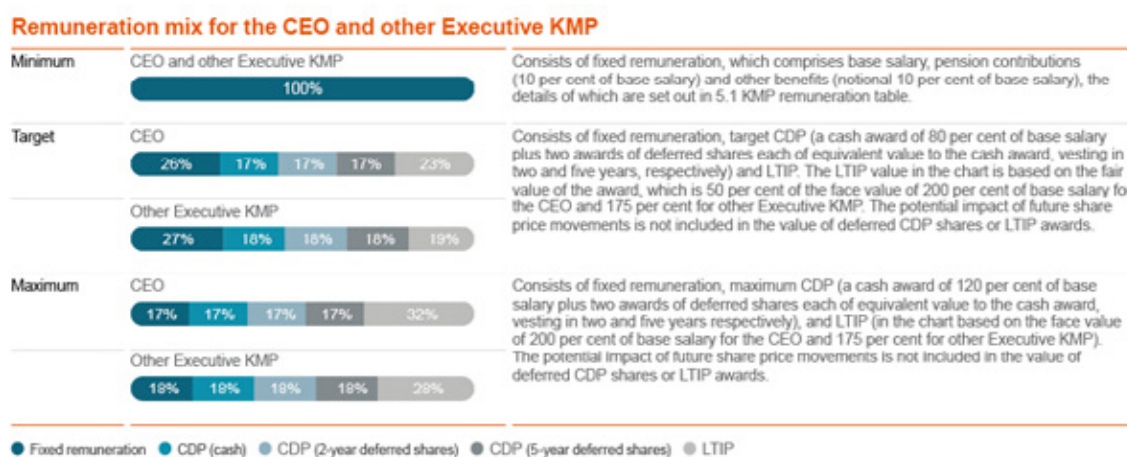

The maximum opportunity represented above is the most that could potentially be paid for each remuneration component. It does not reflect any intention by the Group to award that amount.

## 3 Remuneration for the CEO and other Executive KMP

The amount of remuneration actually received by the CEO and other Executive KMP each year under the CDP and LTIP depends on the achievement of business and individual performance measures. The Board and Committee applies its overarching discretion to determine fair and commensurate remuneration that reflects the objectives of the remuneration framework and takes into account shareholder expectations and market conditions.

### 3.1 FY2024 remuneration received by the CEO

The table below is a voluntary non-statutory disclosure of the remuneration received by the CEO during FY2024 and FY2023. This table is unaudited and differs from the audited remuneration calculated in accordance with the Australian Accounting Standards (refer to 5.1 KMP remuneration table and Financial Statements note 26 'Employee share ownership plans'). This table is designed to provide greater transparency for shareholders and reflects actual remuneration received, with the CDP and LTIP included below representing those amounts that have been received as a consequence of satisfying performance conditions in the relevant financial year.



The difference between the disclosure in the table below and the remuneration disclosed in 5.1 KMP remuneration table relates to the CDP and LTIP. The remuneration calculated in accordance with Australian Accounting Standards requires the fair value of the CDP and LTIP to be calculated at the time of grant and to be amortised over the relevant vesting periods regardless of the performance outcome. This may not reflect what the executive receives. In the table below, the CDP and LTIP values relate to the performance outcomes and actual amount received each year under the CDP (i.e. against the CDP scorecard) and the LTIP (i.e. based on the LTIP vesting outcome).

Details of the components of remuneration are contained in 2 Executive KMP remuneration framework and the values in the table are explained further in the notes below.

US\$('000)		Base salary	Benefits <sup>1</sup>	Pension <sup>2</sup>	CDP <sup>3</sup>	LTIP <sup>4</sup>	Total
<b>Mike Henry</b>	<b>FY2024</b>	<b>1,808</b>	<b>35</b>	<b>181</b>	<b>3,113</b>	<b>3,376</b>	<b>8,513</b>
	FY2023	1,742	7	174	3,762	7,645	13,330

1. Benefits are non-pensionable and include net movements in leave balances, private health insurance, car parking, fringe benefits tax and personal tax return preparation in required countries.

2. FY2024 and FY2023 pension contributions were provided based on 10 per cent of base salary.

3. The values shown are the full CDP value (cash and deferred shares) earned based on performance during FY2024 and FY2023. The FY2024 CDP award will be provided one-third in cash in September 2024 and two-thirds in deferred shares, with one-third due to vest at the end of FY2026 and one-third due to vest at the end of FY2029 (on the terms of the FY2024 CDP award). The FY2023 CDP award was provided one-third in cash in September 2023 and two-thirds in deferred shares, with one-third due to vest at the end of FY2025 and one-third due to vest at the end of FY2028 (on the terms of the FY2023 CDP award).

4. The LTIP award values for FY2024 and FY2023 are based on the full awards Mike Henry received in 2019 and 2018, respectively, when he was President Operations Minerals Australia (prior to becoming and with no proration applied for time as CEO), and 50 per cent of the 2019 awards vesting and 100 per cent of the 2018 awards vesting. The 2019 LTIP award value in FY2024 is an estimate calculated on the average share price for the month of July 2024 (which will be updated for the actual share price on the vesting date in the 2025 Remuneration Report); whereas the 2018 LTIP award value in FY2023 was calculated on the actual share price on the vesting date (and updated from the 2023 Remuneration Report in which the value was an estimate calculated on the average share price for the month of July 2023).

A revised remuneration framework took effect from 1 July 2019 and significantly reduced the LTIP grant size for the CEO from 400 per cent of base salary (on a face value basis) to 200 per cent and a rebalancing to a CDP award with a long-term focus. As a result, the remuneration for Mike Henry reported above reflects the transition to this structure and includes the full amounts of the CDP award earned during FY2024 and FY2023 (i.e. irrespective that some elements of the CDP award are deferred) together with the full amounts of pre-existing LTIP awards vesting at the end of FY2024 and the pre-existing LTIP awards vesting at the end of FY2023 that were granted in 2019 and 2018, respectively. The LTIP award sizes granted in 2019 and 2018 were double the current grant size.

Had the current remuneration framework been in place when Mike's 2019 and 2018 LTIP awards were granted and a reduced size awarded, the reported LTIP values would have been US\$1.688 million for FY2024 and US\$3.827 million for FY2023 (instead of US\$3.376 million and US\$7.645 million in the table above). The reported total remuneration would have therefore been US\$6.825 million for FY2024 and US\$9.512 million for FY2023 (instead of US\$8.513 million and US\$13.330 million in the table above).

### 3.2 FY2024 CDP performance outcomes

The Board and the Committee assessed the Executive KMP's CDP outcomes in light of the Group's performance in FY2024 and took into account performance against the measures in each Executive KMP's CDP scorecard.

For the CEO, the Board's and the Committee's assessment against the CDP scorecard measures resulted in a CDP outcome for FY2024 at 76 per cent against the target of 100 per cent (or 51 per cent against maximum). As noted in the Chair letter, BHP has self-reported certain payroll issues to the FWO and is reviewing its payroll systems. The Board has determined that the CEO's FY2024 CDP outcome will include a 4.3 percentage point reduction from 76 per cent to 71.7 per cent to reflect his ultimate accountability for BHP's payroll systems.

The CEO's final CDP scorecard outcome for FY2024 is summarised in the following tables, including a narrative description of each performance measure and the CEO's level of achievement, as determined by the Committee and approved by the Board. The level of performance for each measure is determined based on a range of threshold (the minimum necessary to qualify for any reward outcome), target (where the performance requirements are met) and maximum (where the performance requirements are significantly exceeded).

## Summary of outcomes for the CEO

Performance measure		Weighting for FY2024	Threshold	Target	Maximum	Percentage outcome Mike Henry
S&S	Significant HSEC events	10%				0%
	Sustainability	15%				15%
Financial		50%				37%
Group		25%				24%
<b>Sub-total</b>		<b>100%</b>				<b>76%</b>
Committee discretion						-4.3%
<b>Total</b>		<b>100%</b>				<b>71.7%</b>

### Safety and sustainability

The safety and sustainability (S&S) targets for the CEO are aligned to the Group's 2030 goals. As it has done for several years, when assessing S&S performance against the scorecard targets, the Committee seeks guidance from the Sustainability Committee. The Committee has taken a holistic view of Group performance in critical areas, including considering any additional matters outside the scorecard targets that the Sustainability Committee has provided and considers relevant.

The performance commentary below is provided against the significant HSEC events (including fatalities) scorecard targets, which were set on the basis of operated assets only.

### Significant HSEC events

Measure outcome Zero

#### Scorecard targets

No significant (actual level 4) health, safety (including fatalities), environment or community events during the year.

#### Performance against scorecard targets

- In what is clearly a tragic and unacceptable outcome, we lost a colleague in January 2024 at our Saraji coal mine, which is part of our BHP Mitsubishi Alliance coal operations in Queensland, Australia. Our imperative is to continue to build our focus on fatality elimination and safety through field leadership, hazard identification and effective risk management.
- The weighting of fatalities is 10 percentage points of the total 25 percentage points allocated to the whole S&S category. This results in a zero outcome for this measure.
- No other significant health, environment or community incidents occurred during FY2024.

The performance commentary below is provided against the sustainability scorecard targets, which were set on the basis of operated assets only.

### Climate change

Measure outcome Slightly below target

#### Scorecard targets

Reported Scopes 1 and 2 GHG emissions at our operated assets in FY2024 are at 10.8 MtCO<sub>2</sub>e.

Deliver the FY2024 actions in the approved climate adaptation work program.

#### Performance against scorecard targets

- For FY2024, we bettered our operational GHG emissions scorecard target of 10.8 MtCO<sub>2</sub>e by 4%, with an outcome of 10.3 MtCO<sub>2</sub>e.<sup>1</sup> This was just below the performance which was required for a maximum outcome of 5% or more below the target. However, having reviewed actual production levels at certain operated assets compared to budget targets, the outcome for this measure was determined by the Committee to be slightly below target.
- All actions required in the approved climate change adaptation work program was delivered during FY2024.

### Indigenous partnerships

Measure outcome Slightly above target

#### Scorecard targets

No significant (actual level 4) cultural heritage events during the year.

Achieve significant uplift from FY2023 total global spend on Indigenous, Traditional Owner and First Nations vendor procurement and achieve FY2024 Indigenous employment participation targets.

#### Performance against scorecard targets

- No significant cultural heritage incidents occurred during FY2024.
- Indigenous, Traditional Owner and First Nations vendor procurement significantly exceeded targets set with US\$609 million in Indigenous procurement spend in FY2024 (an 83% uplift from FY2023). Our overall FY2024 Indigenous employment participation targets were slightly behind target.

1. The operational GHG emissions outcome is different from our reported figures in 6.9 Climate change and our CTAP 2024. This is primarily due to annualisation (over 366 days) of production and GHG emissions for Blackwater and Daunia to reflect the FY2024 scorecard methodology.

The overall outcome against the total S&S measures for FY2024 was 15 per cent out of the target of 25 per cent, with a zero outcome against a target of 10 per cent for the significant HSEC events measure and an outcome of 15 per cent against a target of 15 per cent for sustainability measures.

## Financial

ROCE is underlying profit after taxation (excluding after-taxation finance costs and exceptional items) divided by average capital employed. ROCE is the key financial measure against which CDP outcomes for our senior executives are measured and is, in our view, a relevant measure to assess the financial performance of the Group for this purpose. While ROCE excludes exceptional items, the Committee reviews each exceptional item to assess if it should be included in the result when determining the ROCE CDP outcome.

When assessing management's performance, we make adjustments to the ROCE result to allow for changes in commodity prices, foreign exchange movements and other material items (from the levels assumed in setting the targets). This ensures the assessment appropriately measures outcomes that are within the control and influence of the Group and its executives. Of these adjustments, changes in commodity prices have historically been the most material due to volatility in prices and the impact on Group revenue and ROCE. As it has done for several years, the Committee seeks guidance each year from the Risk and Audit Committee when assessing financial performance against scorecard targets.

<b>ROCE</b>	Measure outcome  <b>Below target</b>
<p><b>Scorecard targets</b> For FY2024, the target for ROCE was 20.1%, with a threshold of 17.1% and a maximum of 22.6%.</p> <p>Achievement of the ROCE target will result in a target CDP outcome. The ROCE target considers the upside opportunities and downside risks inherent in BHP's businesses, and is an outcome the Committee believes would be a level of performance that shareholders would view positively. The maximum and threshold are an appropriate range of ROCE outcomes, given the upside opportunities and downside risks, which represent an upper limit of stretch outperformance that would represent the maximum CDP award, and a lower limit of underperformance below which no CDP award should be made.</p> <p>The performance range around target is subject to a greater level of downside risk than there is upside opportunity, mainly due to physical and regulatory asset constraints. Accordingly, the range between threshold and target is somewhat greater than that between target and maximum. For maximum, the Committee takes care not to create leveraged incentives that encourage executives to push for short-term performance that goes beyond our risk appetite and current operational capacity.</p>	<p><b>Performance against scorecard targets</b> ROCE of 27.2% was reported by BHP for FY2024. Adjusted for the factors outlined below, ROCE is 18.5%, which is below target. The following adjustments were made to ensure the outcomes appropriately reflect the performance of management for the year:</p> <ul style="list-style-type: none"> <li>- The full elimination of the impacts of movements in commodities prices and exchange rates decreased ROCE by 7.7 percentage points.</li> <li>- Adjustments for other material items made to ensure the outcomes reflect the performance of management for the year decreased ROCE by 1 percentage point. This was mainly due to the elimination of the positive effect on reported ROCE outcomes of lower asset values in the closing balance sheet due to the disposals of the Daunia and Blackwater mines in late FY2024. This adjustment was necessary to ensure the basis of the ROCE outcome for CDP purposes was the same as the basis upon which the ROCE target for FY2024 was set.</li> <li>- Having reviewed the FY2024 exceptional items (as described in Financial Statements note 3 'Exceptional items'), the Committee determined these should not be considered for the purposes of determining the FY2024 ROCE CDP outcome and that no further action was required in respect of exceptional items.</li> </ul> <p>The key driver of the FY2024 ROCE outcome of 18.5% being below the target for FY2024 of 20.1% set at the commencement of the year was that actual production volumes at several assets during FY2024 were lower than the internal budgets set at the commencement of the year.</p>

The outcome against the ROCE measure for FY2024 was 37 per cent out of the target of 50 per cent.

## Group measures for the CEO

Group measures for the CEO are determined at the start of the financial year and are an important element of effective performance management. These measures seek to balance financial and non-financial performance requirements and incentivise a high-performance culture. The CEO's group measures for FY2024 included contribution to BHP's overall performance and the management team, and the delivery of key projects and initiatives, as set out in the table below.

## People

Measure outcome

Slightly below target

### Scorecard targets

Increase in female leadership representation by 3 percentage points.  
Accelerate cultural change by launching refreshed BHP values, implementing a refreshed performance management framework and delivery of Operating Model changes.  
Progress ELT succession and development activities.

### Performance against scorecard targets

- Female leadership increased in FY2024 by 2 percentage points to 31.7% at 30 June 2024, compared to 29.7% at 30 June 2023.
- Refreshed Our Values were designed and launched, a refreshed performance management framework is being implemented, and the Operating Model was reviewed, and changes completed.
- Succession and development activities completed in accordance with expectations.

## Performance

Measure outcome

Slightly below target

### Scorecard targets

Asset operational sites to complete formal BHP Operating System (BOS) deployment in FY2024 (>90% schedule adherence throughout). 90% of Sites in Sustain to demonstrate Assessment on Assessment improvement in Operational Excellence Indicator (OEI) scores.  
Drive material progress in our Brazil strategy, including delivery of Renova priority programs (Resettlement and indemnification), Judicial Reorganisation, progress with the National Council of Justice (CNJ) negotiations and UK class action.  
Finalise the development of the CTAP 2024.  
Implement our Reconciliation Action Plan commitments in Australia.

### Performance against scorecard targets

- 94% of asset operational sites completed formal BOS deployment in FY2024 (against the target of >90%). There has been an improvement in OEI scores Assessment on Assessment for 64% of all Sites in Sustain (against the target of >90%).
- Significant progress has been made on the Renova priority programs with 91% of resettlement cases now completed. Compensation and financial assistance to support approximately 430,000 people affected by the dam failure has been paid as at 30 June 2024. Samarco successfully concluded its Judicial Reorganisation process with the approval by the courts. The CNJ negotiations are progressing and judicial proceedings in connection with the dam failure are ongoing.
- The CTAP 2024 has progressed according to plan, being approved by the Board and published as part of the FY2024 Annual Reporting suite of documents.
- All FY2024 Reconciliation Action Plan commitments in Australia were achieved, including developing and embedding an integrated planning, tracking and reporting approach, which is driving accountability and transparency and has been recognised by Reconciliation Australia as best practice. We have made progress on Indigenous procurement spend and employment participation, and listening sessions have been held as part of the Cultural Safety Review and priority improvement identified and underway.

## Portfolio

Measure outcome

On target

### Scorecard targets

As agreed by the Board, execute against the strategy and plan with respect to OZ Minerals integration and other portfolio activities.  
Investments in early stage growth options.

### Performance against scorecard targets

- The OZ Minerals integration program was successfully completed at the end of March 2024. The sale of the Daunia and Blackwater coal mines to Whitehaven Coal was successfully completed in April 2024.
- A number of growth options were progressed, evaluated and approved, and progress was made with an early stage investment in FY2024, which provides future growth optionality.

Overall, the performance of the CEO against the group measures for FY2024 was assessed as slightly below expectations and warranted an outcome of 24 per cent against the target of 25 per cent.

The CDP performance measures for other Executive KMP for FY2024 are similar to those of the CEO outlined above. However, for the other Executive KMP, the weighting of each performance measure will vary to reflect the focus required from each Executive KMP role. As with the CEO, individual performance measures are determined at the start of the financial year. These include the other Executive KMP's contribution to the delivery of projects and initiatives within the scope of their role and the overall performance of the Group. Individual performance of other Executive KMP was reviewed against these measures by the Committee and, on average, were considered to have marginally exceeded expectations and warranted an outcome slightly above target.

The diagram below represents the FY2024 CDP weightings and outcomes against the original scorecard for other Executive KMP.



### 3.3 FY2024 LTIP performance outcomes

The five-year performance period for the 2019 LTIP award for relevant Executive KMP ended on 30 June 2024. Vesting is subject to the achievement of the relative TSR performance conditions and any discretion applied by the Committee (refer to 3.4 Overarching discretion and vesting underpin).

For the 2019 LTIP award to vest in full, BHP's TSR over the performance period from 1 July 2019 to 30 June 2024 must have been at or exceeded the 80th percentile of the Sector Group TSR and the MSCI World Index TSR (World TSR). TSR includes returns to BHP shareholders in the form of share price movements along with dividends paid and reinvested in BHP (including cash and in-specie dividends).

BHP's TSR performance was positive 92 per cent over the five-year period from 1 July 2019 to 30 June 2024. This is above the 50th percentile of the Sector Group TSR of positive 86 per cent but below the 80th percentile of the Sector Group TSR of positive 113 per cent, and above the 50th percentile of the World TSR of positive 58 per cent but below the 80th percentile of the World TSR of positive 117 per cent over the same period. This level of performance results in 50 per cent vesting for the 2019 LTIP award. The value of the CEO's vested 2019 LTIP award has been reported in 3.1 FY2024 remuneration received by the CEO.

The graph below shows BHP's performance relative to comparator groups.

**BHP vs. Sector Group and MSCI World TSR over 2019 LTIP cycle**  
TSR since 1 July 2019 (%)



The value of the vested 2019 LTIP award is higher than the value of the vested award at the time it was granted in 2019. The share price has risen appreciably during the five-year period and there have been strong dividends. Of the value realised, 57 per cent is due to the value at the time the awards were granted and 43 per cent is due to share price appreciation and dividends. This value increment due to share price appreciation and dividends is consistent with the experience of shareholders over the period.

### 3.4 Overarching discretion and vesting underpin

The rules of the CDP and LTIP and the terms and conditions of the awards provide the Committee with an overarching discretion to reduce the number of awards that will vest, notwithstanding that the performance conditions or the relevant service conditions have been met.

This overarching discretion is a holistic, qualitative judgement ('look back') and is applied as an underpin test before final vesting is confirmed. It is an important risk management tool to ensure vesting is not simply driven by a formula or the passage of time that may give unexpected or unintended remuneration outcomes.

The Committee considers its discretion carefully each year ahead of the scheduled vesting of CDP and LTIP equity awards in August. For the five-year CDP deferred awards, it considers performance holistically over the five-year period, including a five-year 'look back' on S&S performance, profitability, cash flow, balance sheet health, returns to shareholders, corporate governance and conduct. For the five years from FY2020 to FY2024, the Committee noted BHP's continued progress in S&S outcomes (noting, however, the two fatalities in FY2023 and one in FY2024 have been taken into account in determining CDP outcomes for those years), strong operational performance with improving production and cost performance, and significant returns to shareholders.

In respect of the vesting of CDP two-year deferred shares (granted in November 2022 in respect of performance in FY2022), the Committee did not identify any reason to exercise its downwards discretion.

In respect of the vesting of the 2019 LTIP five-year performance rights, the formulaic outcome of the 2019 LTIP was 50 per cent vesting. Having undertaken the 'look back' review described above, the Committee concluded the vesting outcome was appropriate given Group and individual performance, and that no reasons were identified to warrant the exercise of its downwards discretion. There is no upwards discretion available to the Committee in respect of the 2019 LTIP and the overarching discretion may only reduce the number of awards that may vest.

In FY2023 BHP identified and disclosed two issues with certain allowances and entitlements affecting some current and former employees in Australia. We self-reported these issues to the FWO and engaged Protiviti, a global assurance firm, to undertake a review of our payroll systems. In August 2023, ELT members had a negative 3 percentage point impact on the FY2023 CDP outcomes due to the costs of remediating the two employee entitlements and allowances issues. We also confirmed that we would monitor the outcome of the review and engagement with the regulatory authorities and that this may impact remuneration outcomes in the future.

The Board and CEO have taken these issues seriously. A range of consequences have been implemented for employees in relation to these matters. In relation to remuneration outcomes, this year the Board has determined that the CEO's FY2024 CDP outcome will include a 4.3 percentage point reduction to reflect his ultimate accountability for BHP's payroll systems. This CDP reduction for the CEO in FY2024 is US\$185,000 and is equivalent to 25 per cent of the CEO's target annual short term incentive pro-rated for the portion of the relevant period that he was CEO. For others with accountability for BHP's payroll issues (including current and prior ELT members) there have been reductions determined in variable remuneration outcomes ranging between 25 per cent to 100 per cent of relevant annual target variable pay. Accountability has been determined based on a number of factors, including tenure in relevant roles.

### 3.5 LTIP allocated during FY2024

Following shareholder approval at the 2023 AGM, 125,124 LTIP awards (in the form of performance rights) were granted to the CEO on 8 November 2023. The face value of the CEO's award was 200 per cent of his base salary of US\$1.820 million at the time of grant. The fair value of the awards were calculated by multiplying the face value of the award by the fair value factor of 41 per cent at the time (as determined by the independent adviser to the Committee). The 125,124 LTIP awards for the CEO was determined based on the US\$ face value of the LTIP awards of US\$3.640 million and calculated using the average share price and US\$/A\$ exchange rate over the 12 months up to and including 30 June 2023. LTIP awards granted to other Executive KMP during FY2024 were determined on the same basis as described above for the CEO, except that awards for other Executive KMP had a face value of 175 per cent of base salary.

In addition to the LTIP terms set out in 2 Executive KMP remuneration framework, the Committee determined the following terms for the 2023 LTIP:

<b>Performance period</b>	<ul style="list-style-type: none"><li>• 1 July 2023 to 30 June 2028</li></ul>
<b>Performance conditions</b>	<ul style="list-style-type: none"><li>• Vesting is conditional on two relative TSR performance measures.</li><li>• An averaging period of six months will be used in the TSR calculations.</li><li>• BHP's TSR relative to the median TSR of the MSCI World Metals and Mining Index (Sector Group TSR) and the MSCI World Index (World TSR) will determine the vesting of 67% and 33% of the award, respectively.</li><li>• For each portion of the award to vest in full, BHP's TSR must be at or exceed the 80th percentile of the Sector Group TSR or the World TSR (as applicable). Threshold vesting (25% of each portion of the award) occurs where BHP's TSR equals the 50th percentile (i.e. the median) of the Sector Group TSR or the World TSR (as applicable). Vesting occurs on a sliding scale between the 50th and 80th percentiles.</li></ul>

### 3.6 FY2025 remuneration for the CEO and other Executive KMP

The remuneration for the CEO and other Executive KMP in FY2025 will be in accordance with the remuneration framework operation and the main elements are set out in the table below.

Base salary	CDP	LTIP
<p>Base salaries are reviewed and benchmarked annually against external market demand for senior executive talent to ensure they remain competitive. Following the review, if the Board and Committee assess and determine a base salary increase should apply to the CEO and/or other Executive KMP, the increase will be applicable from 1 September.</p> <p>For FY2025, the Committee determined that the CEO's base salary would increase by 4%, effective 1 September 2024, to US\$1.893 million. The Committee has also reviewed the base salaries and total target remuneration packages for other Executive KMP. The Committee determined an increase of 8% for the President Australia, reflecting performance and development in role. Given recent appointments, no other changes are being made for other Executive KMP at this time, and this will be the subject of future reviews.</p>	<p>The Board and the Committee set the CDP scorecard performance categories and measures each year.</p> <p>For FY2025, the balanced scorecard includes S&amp;S measures (25% weighting) such as elimination of significant harm (including safety), climate change and Indigenous partnerships, a ROCE financial measure (50% weighting), and Group and individual measures (25% weighting) relating to projects and initiatives in respect of people, performance and portfolio. The specific Group and individual performance measures vary for Executive KMP to reflect the focus required from each of them in their role.</p> <p>Notably, certain S&amp;S, Group and individual measures have a long-term focus where they are set with a view to achieving longer-term ambitions. For example, annual GHG emission reduction targets reflect the ultimate achievement of BHP's medium-term target of at least a 30% reduction in operational GHG emissions from FY2020 levels by FY2030, however, progress towards this is not expected to be linear. As a consequence, vesting of five-year deferred shares under the CDP is underpinned by a holistic review of performance at the end of the five-year vesting period, allowing for performance against the longer-term ambitions to be considered.</p>	<p>The LTIP award to be granted to the CEO in FY2025 has a maximum face value of US\$3.786 million, being 200% of the CEO's base salary at the time of grant. The number of LTIP awards expected to be granted to the CEO in FY2025 is 127,848 and has been determined using the share price and US\$/A\$ exchange rate over the 12 months up to and including 30 June 2024. The granting of this LTIP award is subject to the approval of shareholders at the 2024 AGM. If approved, the award will be granted following the AGM (i.e. in or around November 2024, subject to securities dealing considerations). The LTIP award granted in FY2025 will use the same performance and service conditions as the LTIP award granted in FY2024.</p> <p>LTIP awards granted to other Executive KMP during FY2025 will be calculated on the same basis as described above for the CEO, except that awards for other Executive KMP will have a maximum face value of 175% of salary.</p>

### 4 Remuneration for Non-executive Directors

Our remuneration framework for Non-executive Directors aligns with the Australian Securities Exchange Corporate Governance Council's Principles and Recommendations (4<sup>th</sup> Edition). Non-executive Directors do not have any performance-based at-risk remuneration or receive any equity awards as part of their remuneration, therefore the totals shown below are total remuneration and total fixed fees. The maximum aggregate fees payable to Non-executive Directors (including the Group Chair) were approved by shareholders at the 2008 AGMs at US\$3.800 million per annum. This sum includes base fees, Committee fees and pension contributions. Travel allowances and non-monetary benefits are not included in this limit.

#### 4.1 Remuneration framework of Non-executive Directors

The following table shows the components for Non-executive Directors' remuneration. Non-executive Directors are not eligible to participate in any CDP or LTIP awards.

	<b>Descriptions</b>
<b>Purpose and link to strategy</b>	Competitive fees and benefits are paid to Non-executive Directors in order to attract and retain high-quality individuals, and to provide appropriate remuneration for the role undertaken.
<b>Fees</b>	<p>The Group Chair is paid a single fee for all responsibilities. All other Non-executive Directors are paid a base fee and relevant Committee membership fees. Committee Chairs and the Senior Independent Director are paid an additional fee to reflect their extra responsibilities.</p> <p>All fee levels are reviewed annually and any changes are ordinarily effective from 1 July. Annual reviews take into account global benchmarking and advice provided by external advisers, as required.</p> <p>Fee levels reflect the size and complexity of the Group and the geographies where the Group operates. The economic environment and the financial performance of the Group are taken into account. Consideration is also given to salary reviews across the rest of the Group.</p> <p>Where the payment of pension contributions is required by law, these contributions are deducted from the Director's overall fee entitlements.</p>
<b>Benefits</b>	<p>BHP is a global organisation and there is a considerable travel burden required of Non-executive Directors to travel to Board meetings and site visits. Travel allowances are paid on a per trip basis.</p> <p>As a consequence of our prior dual listed company structure, Non-executive Directors are required to prepare personal tax returns in Australia and the UK, regardless of whether they reside in one or neither of those countries. They are accordingly reimbursed for the costs of personal tax return preparation in whichever of the UK and/or Australia is not their place of residence (including payment of the tax cost associated with the provision of the benefit).</p>

#### Letters of appointment

The Board has adopted a letter of appointment that contains the terms on which Non-executive Directors will be appointed, including the basis upon which they will be indemnified by the Group. The Board has adopted a policy under which all Non-executive Directors must seek re-election at the AGM each year. As a result of requiring re-election each year, Non-executive Directors do not have a fixed term in their letter of appointment.

#### Payments on early termination or loss of office

There are no provisions in any of the Non-executive Directors' appointment arrangements for compensation payable on early termination of their directorship. A Non-executive Director may resign on reasonable notice. No payments are made to Non-executive Directors on loss of office.

#### 4.2 Non-executive Directors' remuneration in FY2024 and FY2025

The remuneration for the Non-executive Directors was paid in FY2024 and will be paid in FY2025 in accordance with the remuneration framework set out above. Fee levels for the Group Chair and the Non-executive Directors are reviewed annually and are benchmarked against peer companies of similar complexity, reach and scale with the assistance of external advisers (but not by the Committee-appointed independent remuneration adviser).

Following an assessment of the updated benchmarking, global market positioning and peer company relativities, a decision has been made that the Group Chair's fee and the Non-executive Directors' base fee will increase by 4 per cent with effect from 1 July 2024. The increases are considered appropriate given current benchmarking and the expectations, accountabilities and workloads of each of the Group Chair and Non-executive Directors. Having conducted this review, it was determined that there would be no change to the fees for other Committee roles or other allowances.



The below table sets out the annualised total remuneration and total fixed fees for FY2024 and FY2025 (including the increases from 1 July 2024).

Levels of fees and travel allowances for Non-executive Directors (in US\$)	FY2024	FY2025
<b>Base annual fee</b>	168,000	175,000
Plus additional fees for:		
<b>Senior Independent Director</b>	53,000	53,000
<b>Committee Chair:</b>		
Risk and Audit	66,000	66,000
People and Remuneration	45,000	45,000
Sustainability	45,000	45,000
Nomination and Governance	No additional fee	No additional fee
<b>Committee membership:</b>		
Risk and Audit	32,500	32,500
People and Remuneration	27,500	27,500
Sustainability	27,500	27,500
Nomination and Governance	18,000	18,000
<b>Travel allowance:<sup>1</sup></b>		
In excess of 3 hours and less than 10 hours	7,000	7,000
10 hours or more	15,000	15,000
<b>Group Chair's fee<sup>2</sup></b>	925,000	962,000

- In relation to travel for Board and shareholder meetings, the time thresholds relate to a flight time in excess of three hours to travel to the meeting location (i.e. one-way flight time). Only one travel allowance is paid per round trip.
- The Group Chair is paid a single fee for all responsibilities (i.e. no base annual fee or Committee fees).

## 5 Statutory KMP remuneration and other disclosures

### 5.1 KMP remuneration table

The table below has been prepared in accordance with relevant accounting standards. Remuneration data for KMP are for the periods of FY2023 and FY2024 that they were KMP. More information on the framework and operation of each element of remuneration is provided earlier in this Report.

#### Share-based payments

The figures included in the shaded columns of the statutory table below for share-based payments were not actually provided to the Executive KMP, including the CEO, during FY2023 or FY2024. These amounts are calculated in accordance with accounting standards and are the amortised IFRS fair values at grant date of equity and equity-related instruments that have been granted to the executives. For information on awards that were allocated and vested during FY2023 and FY2024, refer to 5.2 Equity awards.

US\$('000)	Financial year	Base salary / fees <sup>1</sup>	Short-term benefits			Post-employment benefits	Share-based payments		Total
			Annual cash incentive <sup>2</sup>	Non-monetary benefits <sup>3</sup>	Other benefits <sup>4</sup>	Retirement benefits <sup>5</sup>	Value of CDP awards <sup>2, 6</sup>	Value of LTIP awards <sup>6</sup>	
<b>CEO</b>									
Mike Henry	<b>FY2024</b>	<b>1,808</b>	<b>1,038</b>	<b>35</b>	–	<b>181</b>	<b>2,177</b>	<b>2,096</b>	<b>7,335</b>
	FY2023	1,742	1,254	7	–	174	2,107	2,206	7,490
<b>Other Executive KMP</b>									
Edgar Basto <sup>7</sup>	<b>FY2024</b>	<b>673</b>	<b>425</b>	–	–	<b>67</b>	<b>668</b>	<b>617</b>	<b>2,450</b>
	FY2023	975	704	2	–	98	1,030	820	3,629
Brandon Craig <sup>8</sup>	<b>FY2024</b>	<b>267</b>	<b>173</b>	<b>28</b>	<b>378</b>	<b>27</b>	<b>33</b>	<b>254</b>	<b>1,160</b>
David Lamont <sup>7</sup>	<b>FY2024</b>	<b>673</b>	<b>425</b>	<b>1</b>	–	<b>67</b>	<b>649</b>	<b>641</b>	<b>2,456</b>
	FY2023	975	733	15	–	98	960	608	3,389
Vandita Pant <sup>8</sup>	<b>FY2024</b>	<b>340</b>	<b>223</b>	<b>29</b>	–	<b>34</b>	<b>329</b>	<b>228</b>	<b>1,183</b>
Geraldine Slattery	<b>FY2024</b>	<b>1,013</b>	<b>592</b>	<b>26</b>	<b>297</b>	<b>101</b>	<b>1,182</b>	<b>1,049</b>	<b>4,260</b>
	FY2023	950	665	113	400	95	1,117	947	4,287
Ragnar Udd <sup>7</sup>	<b>FY2024</b>	<b>665</b>	<b>431</b>	<b>48</b>	–	<b>67</b>	<b>644</b>	<b>575</b>	<b>2,430</b>
	FY2023	917	711	49	–	92	911	748	3,428

US\$('000)	Financial year	Base salary / fees <sup>1</sup>	Short-term benefits			Post-employment benefits	Share-based payments		Total
			Annual cash incentive <sup>2</sup>	Non-monetary benefits <sup>3</sup>	Other benefits <sup>4</sup>	Retirement benefits <sup>5</sup>	Value of CDP awards <sup>2, 6</sup>	Value of LTIP awards <sup>6</sup>	
<b>Non-executive Directors</b>									
Terry Bowen <sup>9</sup>	<b>FY2024</b>	<b>78</b>	–	–	–	7	–	–	<b>85</b>
	FY2023	241	–	–	40	17	–	–	298
Malcolm Broomhead <sup>9</sup>	FY2023	61	–	–	15	6	–	–	82
Xiaoqun Clever-Steg	<b>FY2024</b>	<b>188</b>	–	–	77	13	–	–	<b>278</b>
	FY2023	181	–	–	79	12	–	–	272
Ian Cockerill <sup>9</sup>	<b>FY2024</b>	<b>162</b>	–	–	46	12	–	–	<b>220</b>
	FY2023	208	–	–	106	12	–	–	326
Gary Goldberg	<b>FY2024</b>	<b>284</b>	–	–	99	–	–	–	<b>383</b>
	FY2023	284	–	–	101	–	–	–	385
Michelle Hinchliffe	<b>FY2024</b>	<b>235</b>	–	–	45	–	–	–	<b>280</b>
	FY2023	186	–	–	37	6	–	–	229
Don Lindsay <sup>10</sup>	<b>FY2024</b>	<b>38</b>	–	–	–	–	–	–	<b>38</b>
Ken MacKenzie	<b>FY2024</b>	<b>907</b>	–	–	67	18	–	–	<b>992</b>
	FY2023	863	–	–	63	17	–	–	943
Ross McEwan <sup>10</sup>	<b>FY2024</b>	<b>51</b>	–	–	45	4	–	–	<b>100</b>
John Mogford <sup>9</sup>	FY2023	63	–	–	33	–	–	–	96
Christine O'Reilly	<b>FY2024</b>	<b>263</b>	–	–	37	–	–	–	<b>300</b>
	FY2023	268	–	–	55	–	–	–	323
Catherine Tanna	<b>FY2024</b>	<b>205</b>	–	–	44	18	–	–	<b>267</b>
	FY2023	198	–	–	52	17	–	–	267
Dion Weisler	<b>FY2024</b>	<b>205</b>	–	–	22	18	–	–	<b>245</b>
	FY2023	198	–	–	55	17	–	–	270

<sup>1</sup> Base salaries and fees shown in this table reflect the amounts paid over the 12-month period from 1 July 2023 to 30 June 2024 for each Executive KMP and Non-executive Director. In FY2024, the Executive KMP base salaries were increased from 1 September 2023 as follows: Mike Henry's to US\$1.820 million, Edgar Basto's to US\$1.020 million, David Lamont's to US\$1.020 million, Geraldine Slattery's to US\$1.020 million and Ragnar Udd's to US\$1.020 million. The other changes to Executive KMP base salaries during the year were as follows: Brandon Craig who was appointed President Americas on 1 March 2024 on an annual salary of US\$0.800 million and Vandita Pant who was appointed Chief Financial Officer on 1 March 2024 on an annual salary of US\$1.020 million.

<sup>2</sup> Annual cash incentive in this table is the cash portion of CDP awards each Executive KMP earned in respect of performance during each financial year. CDP is provided one-third in cash and two-thirds in deferred shares (which are included in the share-based payments columns of the table). The cash portion of CDP awards is paid in September of the year following the relevant financial year. The minimum possible value awarded to each individual is nil, the target is 240 per cent of base salary (80 per cent in cash and 160 per cent in deferred shares) and the maximum is 360 per cent of base salary (120 per cent in cash and 240 per cent in deferred shares). For FY2024, Executive KMP earned the following CDP awards as a percentage of the target and maximum (the remaining portion has been forfeited): Mike Henry 71.7 per cent of target and 47.8 per cent of maximum, Edgar Basto 79 per cent of target and 53 per cent of maximum, Brandon Craig 81 per cent of target and 54 per cent of maximum, David Lamont 79 per cent of target and 53 per cent of maximum, Vandita Pant 82 per cent of target and 55 per cent of maximum, Geraldine Slattery 73 per cent of target and 49 per cent of maximum and Ragnar Udd 81 per cent of target and 54 per cent of maximum.

<sup>3</sup> Non-monetary benefits are non-pensionable and include items such as net leave accruals, private family health insurance, car parking, fringe benefits tax and personal tax return preparation in required countries.

<sup>4</sup> Other benefits are non-pensionable and for FY2024 include a one-off relocation allowance provided to Brandon Craig relating to his international relocation from Australia to Chile and one-off reimbursement to Geraldine Slattery associated with her house sale/purchase for international relocation from the United States to Australia. The majority of the amounts disclosed for benefits for Non-executive Directors are usually travel allowances: amounts of between US\$ nil and US\$105,000 for FY2024 and FY2023. For FY2024, amounts of between US\$ nil and US\$1,500 (US\$ nil and US\$3,000 for FY2023) are included in respect of tax return preparation, and amounts of between US\$ nil and US\$800 for FY2024 (US\$ nil and US\$1,400 for FY2023) are included in respect of the reimbursement of the tax cost associated with the provision of taxable benefits.

<sup>5</sup> Retirement benefits for each Executive KMP in FY2023 and FY2024 were 10 per cent of base salary as per the remuneration framework. Non-executive Director fees are inclusive of minimum superannuation contributions of up to 11 per cent of remuneration for FY2024 (10.5 per cent for FY2023) in accordance with Australian superannuation legislation. No other pension contributions were paid.

<sup>6</sup> The IFRS fair value of CDP and LTIP awards is estimated at grant date. Refer to Financial Statements note 26 'Employee share ownership plans'.

- 7 The FY2024 remuneration reported for Edgar Basto, David Lamont and Ragnar Udd reflects services as Executive KMP up to 29 February 2024.
- 8 The FY2024 remuneration reported for Brandon Craig and Vandita Pant reflects services as Executive KMP from 1 March 2024.
- 9 The FY2024 remuneration for Terry Bowen and Ian Cockerill relates to part of the year only, as they retired from the Board on 1 November 2023 and 4 April 2024, respectively. The FY2023 remuneration for Malcolm Broomhead and John Mogford relates to part of the year only, as they retired from the Board on 10 November 2022 and 31 October 2022, respectively.
- 10 The FY2024 remuneration reported for Don Lindsay and Ross McEwan relates to part of the year only, as they joined the Board on 1 May 2024 and 3 April 2024, respectively.

## 5.2 Equity awards

The interests held by Executive KMP under the Group's employee equity plans are set out in the table below. Each equity award is a right to acquire one ordinary share in BHP Group Limited upon satisfaction of the vesting conditions. Our mandatory minimum performance requirements for securities dealing governs and restricts dealing arrangements and the provision of shares on vesting or exercise of awards. No interests under the Group's employee equity plans are held by related parties of Executive KMP.

Approval from BHP's shareholders for the issue of equity awards to the CEO under the CDP and LTIP was obtained under ASX Listing Rule 10.14 at the 2023 AGM.

DEP applies to awards provided to Executive KMP under the CDP and LTIP as detailed in 2 Executive KMP remuneration framework. No DEP is generally payable on MAP awards previously provided to Executive KMP.

Executive KMP received or will receive awards under the CDP and LTIP. The terms and conditions of CDP and LTIP awards, including the performance conditions, are described in 2 Executive KMP remuneration framework.

BHP senior management who are not KMP receive awards under the MAP. While no MAP awards were granted to Executive KMP after becoming KMP, as noted in the table below, Edgar Basto, Brandon Craig, Vandita Pant, Geraldine Slattery and Ragnar Udd hold or held MAP awards that were allocated to them prior to commencing their Executive KMP service.

Award type	Date of grant	At 1 July 2023	Granted	Vested	Lapsed	At 30 June 2024	Award vesting date <sup>1</sup>	Market price on date of:		Gain on awards ('000) <sup>4</sup>	DEP on awards ('000)
								Grant <sup>2</sup>	Vesting <sup>3</sup>		
<b>Mike Henry</b>											
CDP	8-Nov-23	–	43,106	–	–	43,106	Aug 28	A\$44.70	–	–	–
CDP	8-Nov-23	–	43,106	–	–	43,106	Aug 25	A\$44.70	–	–	–
CDP	22-Nov-22	44,335	–	–	–	44,335	Aug 27	A\$43.48	–	–	–
CDP	22-Nov-22	44,335	–	–	–	44,335	Aug 24	A\$43.48	–	–	–
CDP	23-Nov-21	55,246	–	–	–	55,246	Aug 26	A\$38.05	–	–	–
CDP	23-Nov-21	55,246	–	55,246	–	–	25 Aug 23	A\$38.05	A\$43.02	A\$2,377	A\$527
CDP	20-Oct-20	49,692	–	–	–	49,692	Aug 25	A\$35.90	–	–	–
LTIP	8-Nov-23	–	125,124	–	–	125,124	Aug 28	A\$44.70	–	–	–
LTIP	22-Nov-22	118,853	–	–	–	118,853	Aug 27	A\$43.48	–	–	–
LTIP	23-Nov-21	120,099	–	–	–	120,099	Aug 26	A\$38.05	–	–	–
LTIP	20-Oct-20	157,138	–	–	–	157,138	Aug 25	A\$35.90	–	–	–
LTIP	20-Nov-19	172,144	–	–	–	172,144	Aug 24	A\$37.24	–	–	–
LTIP	18-Dec-18	193,189	–	193,189	–	–	25 Aug 23	A\$33.50	A\$43.02	A\$8,311	A\$3,397
<b>Edgar Basto<sup>5</sup></b>											
CDP	8-Nov-23	–	24,201	–	–	24,201	Aug 28	A\$44.70	–	–	–
CDP	8-Nov-23	–	24,201	–	–	24,201	Aug 25	A\$44.70	–	–	–
CDP	22-Nov-22	21,936	–	–	–	21,936	Aug 27	A\$43.48	–	–	–
CDP	22-Nov-22	21,936	–	–	–	21,936	Aug 24	A\$43.48	–	–	–
CDP	23-Nov-21	30,604	–	–	–	30,604	Aug 26	A\$38.05	–	–	–
CDP	23-Nov-21	30,604	–	30,604	–	–	25 Aug 23	A\$38.05	A\$43.02	A\$1,317	A\$292
LTIP	8-Nov-23	–	61,359	–	–	61,359	Aug 28	A\$44.70	–	–	–
LTIP	22-Nov-22	58,237	–	–	–	58,237	Aug 27	A\$43.48	–	–	–
LTIP	23-Nov-21	58,725	–	–	–	58,725	Aug 26	A\$38.05	–	–	–
LTIP	20-Oct-20	76,835	–	–	–	76,835	Aug 25	A\$35.90	–	–	–
MAP	19-May-20	31,649	–	–	–	31,649	Aug 24	A\$35.05	–	–	–
MAP	19-May-20	31,649	–	31,649	–	–	25 Aug 23	A\$35.05	A\$43.02	A\$1,362	–

Award type	Date of grant	At 1 July 2023			At 30 June 2024			Award vesting date <sup>1</sup>	Market price on date of:		Gain on awards ('000) <sup>4</sup>	DEP on awards ('000)
		Granted	Vested	Lapsed	Granted	Vested	Lapsed		Grant <sup>2</sup>	Vesting <sup>3</sup>		
<b>Brandon Craig<sup>6</sup></b>												
MAP	8-Dec-23	23,600	–	–	–	23,600	Aug 28	A\$47.74	–	–	–	–
MAP	8-Dec-23	23,600	–	–	–	23,600	Aug 27	A\$47.74	–	–	–	–
MAP	27-Sep-23	23,600	–	–	–	23,600	Aug 26	A\$43.49	–	–	–	–
MAP	21-Sep-22	19,938	–	–	–	19,938	Aug 25	A\$37.96	–	–	–	–
MAP	29-Sep-21	19,945	–	–	–	19,945	Aug 24	A\$36.39	–	–	–	–
<b>David Lamont<sup>5</sup></b>												
CDP	8-Nov-23	–	25,203	–	–	25,203	Aug 28	A\$44.70	–	–	–	–
CDP	8-Nov-23	–	25,203	–	–	25,203	Aug 25	A\$44.70	–	–	–	–
CDP	22-Nov-22	24,775	–	–	–	24,775	Aug 27	A\$43.48	–	–	–	–
CDP	22-Nov-22	24,775	–	–	–	24,775	Aug 24	A\$43.48	–	–	–	–
CDP	23-Nov-21	18,009	–	–	–	18,009	Aug 26	A\$38.05	–	–	–	–
CDP	23-Nov-21	18,009	–	18,009	–	–	25 Aug 23	A\$38.05	A\$43.02	A\$775	A\$172	–
LTIP	8-Nov-23	–	61,359	–	–	61,359	Aug 28	A\$44.70	–	–	–	–
LTIP	22-Nov-22	58,237	–	–	–	58,237	Aug 27	A\$43.48	–	–	–	–
LTIP	23-Nov-21	58,725	–	–	–	58,725	Aug 26	A\$38.05	–	–	–	–
LTIP	1-Dec-20	76,835	–	–	–	76,835	Aug 25	A\$38.56	–	–	–	–
<b>Vandita Pant<sup>6</sup></b>												
CDP	8-Nov-23	22,682	–	–	–	22,682	Aug 28	A\$44.70	–	–	–	–
CDP	8-Nov-23	22,682	–	–	–	22,682	Aug 25	A\$44.70	–	–	–	–
CDP	22-Nov-22	17,834	–	–	–	17,834	Aug 27	A\$43.48	–	–	–	–
CDP	22-Nov-22	17,834	–	–	–	17,834	Aug 27	A\$43.48	–	–	–	–
CDP	23-Nov-21	20,347	–	–	–	20,347	Aug 26	A\$38.05	–	–	–	–
LTIP	8-Nov-23	45,632	–	–	–	45,632	Aug 28	A\$44.70	–	–	–	–
LTIP	22-Nov-22	43,296	–	–	–	43,296	Aug 27	A\$43.48	–	–	–	–
LTIP	23-Nov-21	34,440	–	–	–	34,440	Aug 26	A\$38.05	–	–	–	–
MAP	20-Oct-20	27,731	–	–	–	27,731	Aug 25	A\$35.90	–	–	–	–
MAP	20-Nov-19	26,197	–	–	–	26,197	Aug 24	A\$37.24	–	–	–	–
<b>Geraldine Slattery</b>												
CDP	8-Nov-23	–	22,870	–	–	22,870	Aug 28	A\$44.70	–	–	–	–
CDP	8-Nov-23	–	22,870	–	–	22,870	Aug 25	A\$44.70	–	–	–	–
CDP	22-Nov-22	23,784	–	–	–	23,784	Aug 27	A\$43.48	–	–	–	–
CDP	22-Nov-22	23,784	–	–	–	23,784	Aug 24	A\$43.48	–	–	–	–
CDP	23-Nov-21	28,258	–	–	–	28,258	Aug 26	A\$38.05	–	–	–	–
CDP	23-Nov-21	28,258	–	28,258	–	–	25 Aug 23	A\$38.05	A\$43.02	A\$1,216	A\$269	–
CDP	20-Oct-20	28,562	–	–	–	28,562	Aug 25	A\$35.90	–	–	–	–
LTIP	8-Nov-23	–	61,359	–	–	61,359	Aug 28	A\$44.70	–	–	–	–
LTIP	22-Nov-22	58,237	–	–	–	58,237	Aug 27	A\$43.48	–	–	–	–
LTIP	23-Nov-21	52,543	–	–	–	52,543	Aug 26	A\$38.05	–	–	–	–
LTIP	20-Oct-20	60,660	–	–	–	60,660	Aug 25	A\$35.90	–	–	–	–
LTIP	20-Nov-19	117,371	–	–	–	117,371	Aug 24	A\$37.24	–	–	–	–
MAP	21-Feb-19	31,965	–	31,965	–	–	25 Aug 23	A\$34.83	A\$43.02	A\$1,375	–	–
<b>Ragnar Udd<sup>5</sup></b>												
CDP	8-Nov-23	–	24,452	–	–	24,452	Aug 28	A\$44.70	–	–	–	–
CDP	8-Nov-23	–	24,452	–	–	24,452	Aug 25	A\$44.70	–	–	–	–
CDP	22-Nov-22	22,167	–	–	–	22,167	Aug 27	A\$43.48	–	–	–	–
CDP	22-Nov-22	22,167	–	–	–	22,167	Aug 24	A\$43.48	–	–	–	–
CDP	23-Nov-21	18,415	–	–	–	18,415	Aug 26	A\$38.05	–	–	–	–
CDP	23-Nov-21	18,415	–	18,415	–	–	25 Aug 23	A\$38.05	A\$43.02	A\$792	A\$176	–
LTIP	8-Nov-23	–	61,359	–	–	61,359	Aug 28	A\$44.70	–	–	–	–
LTIP	22-Nov-22	55,266	–	–	–	55,266	Aug 27	A\$43.48	–	–	–	–
LTIP	23-Nov-21	52,543	–	–	–	52,543	Aug 26	A\$38.05	–	–	–	–
LTIP	2-Nov-20	68,748	–	–	–	68,748	Aug 25	A\$33.81	–	–	–	–
MAP	21-Aug-20	23,790	–	–	–	23,790	Aug 24	A\$38.36	–	–	–	–
MAP	21-Aug-20	23,790	–	23,790	–	–	25 Aug 23	A\$38.36	A\$43.02	A\$1,023	–	–

<sup>1</sup> Where the vesting date is not yet known, the estimated vesting month is shown. Where awards lapsed (if any), the lapse date is shown. If the vesting conditions are met, awards will vest on or as soon as practicable after the first non-prohibited period date occurring after 30 June of the preceding year, subject to the terms of the award. The year of vesting is the second (CDP two-year deferred share awards), third (MAP), fourth (MAP) or fifth (MAP, CDP five-year deferred share awards and LTIP) financial year after grant. All awards are conditional awards and have no exercise period or exercise price; instead, ordinary fully paid shares are automatically allocated upon vesting (subject to a discretion to provide cash in lieu). Where vesting conditions are not met, the conditional awards will immediately lapse.

<sup>2</sup> The market price shown is the closing price of BHP shares on the relevant date of grant. No price is payable by the individual to receive a grant of awards. The IFRS fair value of the CDP and LTIP awards granted in FY2024 at the grant date of 8 November 2023 are as follows: CDP – A\$45.95 and LTIP – A\$30.33.

<sup>3</sup> The market price shown is the closing price of BHP shares on the relevant date of vest.

<sup>4</sup> The gain on awards is calculated using the market price on date of vesting or exercise (as applicable) less any exercise price payable. The amounts that vested for the awards during FY2024 are as follows: CDP – 100 per cent vested; LTIP – 100 per cent vested; MAP – 100 per cent vested.

<sup>5</sup> Awards shown as held by Edgar Basto, David Lamont and Ragnar Udd at 30 June 2024 are their balances at the date they ceased being KMP, being 29 February 2024.

<sup>6</sup> The opening balances of awards for Brandon Craig and Vandita Pant reflect their holdings on the date that each became KMP, being 1 March 2024.

### 5.3 Estimated value range of equity awards

The current face value (and estimate of the maximum possible total value) of equity awards allocated during FY2024 and yet to vest are the awards as set out in the previous table multiplied by the current share price of BHP Group Limited. The minimum possible total value of the awards is nil. The actual value that may be received by participants in the future cannot be determined as it is dependent on and therefore fluctuates with the share price of BHP Group Limited at the date that any particular award vests or is exercised.

#### Five-year share price, dividend and earnings history

The table below provides the five-year share price history for BHP Group Limited, history of dividends paid and the Group's earnings.

	<b>FY2024</b>	<b>FY2023</b>	<b>FY2022</b>	<b>FY2021</b>	<b>FY2020</b>
Share price at beginning of year (A\$)	<b>45.26</b>	40.05	48.22	35.82	41.68
Share price at end of year (A\$)	<b>42.68</b>	44.99	41.25	48.57	35.82
Dividends paid (A\$)	<b>2.35</b>	3.92	10.18 <sup>1</sup>	2.07	2.13
Attributable profit (US\$ million, as reported)	<b>7,897</b>	12,921	30,900	11,304	7,956

<sup>1</sup> The FY2022 dividends paid includes A\$5.38 in respect of the in-specie dividend associated with the merger of the Petroleum business with Woodside.

The highest and lowest closing share price during FY2024 were A\$50.72 and A\$41.95 respectively.

## 5.4 Ordinary shareholdings and transactions

The number of ordinary shares in BHP Group Limited held directly, indirectly or beneficially by each individual (including shares held in the name of all close members of the Director's or Executive KMP's family and entities over which either the Director or Executive KMP or the family member has directly or indirectly control, joint control or significant influence) is shown below. No shares are held nominally by any KMP or their related parties. These are ordinary shares held without performance conditions or restrictions and are included in MSR calculations for each individual.

	Held at 1 July 2023	Purchased	Received as remuneration <sup>1</sup>	Sold	Held at 30 June 2024
Mike Henry	677,218	–	248,435	515,652	410,001
Edgar Basto <sup>2</sup>	146,806	–	62,253	22,560	186,499
Brandon Craig <sup>3</sup>	25,665	–	–	–	25,665
David Lamont <sup>2</sup>	86,235	–	21,932	45,000	63,167
Vandita Pant <sup>3</sup>	170,688	–	–	–	170,688
Geraldine Slattery <sup>4</sup>	164,088	–	60,223	29,300	195,011
Ragnar Udd <sup>2</sup>	131,559	–	42,205	42,205	131,559
Terry Bowen <sup>5</sup>	11,000	–	–	–	11,000
Xiaoqun Clever-Steg	8,539	–	–	–	8,539
Ian Cockerill <sup>5</sup>	14,299	–	–	–	14,299
Gary Goldberg <sup>4</sup>	16,000	2,000	–	–	18,000
Michelle Hinchliffe	8,508	1,599	–	–	10,107
Don Lindsay <sup>6</sup>	–	–	–	–	–
Ken MacKenzie	58,446	–	–	–	58,446
Ross McEwan <sup>6</sup>	–	–	–	–	–
Christine O'Reilly	9,420	–	–	–	9,420
Catherine Tanna	10,400	–	–	–	10,400
Dion Weisler	7,544	–	–	–	7,544

<sup>1</sup> Includes DEP in the form of shares on equity awards vesting, where applicable, as disclosed in 5.2 Equity awards.

<sup>2</sup> Shares shown as held by Edgar Basto, David Lamont and Ragnar Udd at 30 June 2024 are their balances at the date they ceased being KMP on 29 February 2024.

<sup>3</sup> The opening balances for Brandon Craig and Vandita Pant reflect their shareholdings on the date that each became KMP being 1 March 2024.

<sup>4</sup> The following BHP Group Limited shares were held in the form of American Depositary Shares: 2,042 for Geraldine Slattery and 9,000 for Gary Goldberg.

<sup>5</sup> Shares shown as held by Terry Bowen and Ian Cockerill at 30 June 2024 are their balances at the date of their retirement from the Board on 1 November 2023 and 4 April 2024, respectively.

<sup>6</sup> The opening balances for Don Lindsay and Ross McEwan reflect their shareholdings on the date they became Non-executive Directors being 1 May 2024 and 3 April 2024, respectively.

## 5.5 Prohibition on hedging of BHP shares and equity instruments

The Executive KMP may not use unvested BHP equity awards as collateral or hedge the value of any unvested BHP equity awards or the value of shares and securities held as part of meeting the MSR.

Any securities that have vested and are no longer subject to restrictions, or not held as part of meeting the MSR, may be subject to hedging arrangements or used as collateral, provided that prior consent is obtained.

## 5.6 Share ownership guidelines and the MSR

The share ownership guidelines and the MSR help to ensure the interests of Directors, executives and shareholders remain aligned.

The CEO and other Executive KMP are expected to grow their holdings to the MSR from the scheduled vesting of their employee awards over time. The MSR is tested at the time that shares are to be sold. Shares may be sold to satisfy tax obligations arising from the granting, holding, vesting, exercise or sale of the employee awards or the underlying shares whether the MSR is satisfied at that time or not.

For FY2024:

- The MSR for the CEO was five times annual pre-tax base salary. At the end of FY2024, the CEO met the MSR.
- The MSR for other Executive KMP was three times annual pre-tax base salary. At the end of FY2024, the other Executive KMP met the MSR except for Brandon Craig, as he was appointed to the ELT and as Executive KMP on 1 March 2024.
- No Executive KMP sold or purchased shares during FY2024, other than sales to satisfy taxation obligations, except for Mike Henry, who sold shares due to marital divorce, including reorganisation of holdings, and Ragnar Udd, who sold shares in order to partially fund the purchase of a residential dwelling.

A two-year post-retirement shareholding requirement for the CEO applies from the date of retirement, which will be the lower of the CEO's MSR or the CEO's actual shareholding at the date of retirement.

Subject to securities dealing constraints, Non-executive Directors have agreed to apply at least 25 per cent of their remuneration (base fees plus Committee fees) to the purchase of BHP shares until they achieve an MSR equivalent in value to one year of remuneration (base fees plus Committee fees). Thereafter, they must maintain at least that level of shareholding throughout their tenure. At the end of FY2024, each Non-executive Director met the MSR except for Don Lindsay and Ross McEwan, as they joined the Board on 1 May 2024 and 3 April 2024, respectively.

## 5.7 Transactions with KMP

During the financial year, there were no transactions between the Group and its subsidiaries and KMP (including their related parties) (2023: US\$ nil; 2022: US\$ nil). There were no amounts payable by or loans with KMP (including their related parties) at 30 June 2024 (2023: US\$ nil; 2022: US\$ nil).

A number of KMP hold or have held positions in other companies (i.e. personally related entities) where it is considered they control or significantly influence the financial or operating policies of those entities. There have been no transactions with those entities and no amounts were owed by the Group to personally related entities or any other related parties (2023: US\$ nil; 2022: US\$ nil).

This Remuneration Report was approved by the Board on 27 August 2024 and signed on its behalf by:

/s/ Christine O'Reilly

**Christine O'Reilly**

Chair, People and Remuneration Committee

27 August 2024

**Financial Statements**

Refer to the pages beginning on page F-1 in this Annual Report.

For personal use only



## Additional information

### 1 Information on mining operations

#### Minerals Australia

#### Iron ore mining operations

The following table contains additional details of our iron ore mining operations. This table should be read in conjunction with OFR 5.1 and the production table and reserves and resources tables in Additional information 4 and 6.

#### Mine & location

<b>WAIO</b>	Pilbara region, Western Australia Newman West (Mt Whaleback, Orebodies 29, 30, 31 and 35) Newman East (Orebodies 24, 25 and 32)
Mt Newman joint venture	
<b>Means of access</b>	Private road Ore transported by Mt Newman JV-owned rail to Port Hedland (427 km)
<b>Type and amount of ownership</b>	BHP Minerals 85% Mitsui-ITOCHU Iron 10% ITOCHU Minerals and Energy of Australia 5%
<b>Operator</b>	BHP
<b>Title, leases or options and acreage involved</b>	Mineral lease granted and held under the Iron Ore (Mount Newman) Agreement Act 1964 expires in 2030 with right to successive renewals of 21 years each ML244SA – approximately 78,934 hectares
<b>History and stage of property</b>	Production stage Production began at Mt Whaleback in 1969 Production from Orebodies 24, 25, 29, 30, 31, 32 and 35 complements production from Mt Whaleback Production from Orebodies 31 and 32 started in 2015 and 2017 respectively Mining at Orebody 18 ceased in 2020 after depletion
<b>Mine type &amp; mineralisation style</b>	Open-cut Bedded ore types classified as per host Archaean or Proterozoic iron formation, which are Brockman and Marra Mamba; also present is iron-rich detrital material
<b>Power source</b>	Power for all mine operations in the Central and Eastern Pilbara is supplied by BHP's natural gas-fired Yarnima power station Power consumed in port operations is supplied via a contract with APA Group (formerly Alinta)
<b>Processing plants and other available facilities</b>	Newman Hub: primary crusher, ore handling plant, heavy media beneficiation plant, stockyard blending facility, single cell rotary car dumper, train load out (nominal capacity 75 Mtpa) Orebody 25: Ore processing plant (nominal capacity 12 Mtpa) ceased operation mid-FY2022
<b>Key permit conditions</b>	State Agreement contains conditions set by the Western Australian Government, including requirements for future development proposals; environmental compliance and reporting obligations; closure and rehabilitation considerations; local procurement and community plans/initiatives/investment requirements; payment of rent, taxes and government royalties Tenements granted by the Western Australian Government under the Mining Act 1978 (WA) (WA Mining Act) Key permit conditions include resource reporting, environmental compliance and reporting, rehabilitation considerations and offset payments and payment of lease rentals and royalties Registered Indigenous Land Use Agreements with conditions, including appropriate native title compensation and opportunity sharing; enshrine heritage protections and land access rights; and guarantee certain heritage, environment and consultation processes

**Mine & location**

<b>WAIO</b>	Pilbara region, Western Australia
Yandi joint venture	
<b>Means of access</b>	Private road  Ore transported by Mt Newman JV-owned rail to Port Hedland (316 km)  Yandi JV's railway spur links Yandi hub to Mt Newman JV main line
<b>Type and amount of ownership</b>	BHP Minerals 85%  ITOCHU Minerals and Energy of Australia 8%  Mitsui Iron Ore Corporation 7%
<b>Operator</b>	BHP
<b>Title, leases or options and acreage involved</b>	Mining lease granted pursuant to the Iron Ore (Marillana Creek) Agreement Act 1991 expires in 2033 with 1 renewal right to a further 21 years to 2054  M270SA – approximately 30,344 hectares
<b>History and stage of property</b>	Production stage  Production began at the Yandi mine in 1992  Capacity of Yandi hub expanded between 1994 and 2013  Yandi commenced production ramp down activity in FY2022
<b>Mine type &amp; mineralisation style</b>	Open-cut  Channel iron deposits are Cainozoic fluvial sediments
<b>Power source</b>	Power for all mine operations in the Central and Eastern Pilbara is supplied by BHP's natural gas-fired Yarnima power station  Power consumed in port operations is supplied via a contract with APA Group (formerly Alinta)
<b>Processing plants and other available facilities</b>	2 primary crushers, 1 ore handling plant, stockyard blending facility and 1 train load out (nominal capacity 50 Mtpa)  Decommissioning of additional facilities, including 2 ore handling plants, 2 primary crushers and 1 train load out, is ongoing as part of planned ramp down activities
<b>Key permit conditions</b>	State Agreement contains conditions set by the Western Australian Government, including requirements for future development proposals; environmental compliance and reporting obligations; closure and rehabilitation considerations; local procurement and community plans/initiatives/investment requirements; payment of rent, taxes and government royalties  Tenements granted by the Western Australian Government under the WA Mining Act  Key permit conditions include resource reporting, environmental compliance and reporting, rehabilitation considerations and offset payments and payment of lease rentals and royalties  Registered Indigenous Land Use Agreements with conditions, including appropriate native title compensation and opportunity sharing; enshrine heritage protections and land access rights; and guarantee certain heritage, environment and consultation processes

**Mine & location**

<b>WAIO</b>	<p>Pilbara region, Western Australia</p> <p>Jimblebar</p> <p>Bill's Hill, Eastern Syncline and Mt Helen (jointly called Western Ridge deposits)</p>
Jimblebar operation*	
<b>Means of access</b>	<p>Private road</p> <p>Jimblebar ore is transported via overland conveyor (12.4 km) and by Mt Newman JV-owned rail to Port Hedland (428 km)</p> <p>The Western Ridge deposits are located close to Newman Operations and all production will be trucked and/or transported via overland conveyor</p>
<b>Type and amount of ownership</b>	<p>BHP Minerals 85%</p> <p>ITOCHU Minerals and Energy of Australia 8%</p> <p>Mitsui &amp; Co. Iron Ore Exploration &amp; Mining 7%</p> <p>*Jimblebar is an 'incorporated' venture with the above companies holding A Class Shares with rights to certain parts of mining lease 266SA held by BHP Iron Ore (Jimblebar) Pty Ltd (BHPIOJ)</p> <p>BHP Minerals holds 100% of the B Class Shares, which has rights to all other Jimblebar assets</p>
<b>Operator</b>	BHP
<b>Title, leases or options and acreage involved</b>	<p>Mining lease granted pursuant to the Iron Ore (McCamey's Monster) Agreement Authorisation Act 1972 expires in 2030 with rights to successive renewals of 21 years each</p> <p>M266SA – approximately 51,756 hectares</p>
<b>History and stage of property</b>	<p>Production stage</p> <p>Production began in March 1989</p> <p>From 2004, production was transferred to Wheelarra JV as part of the Wheelarra sublease agreement</p> <p>This sublease agreement expired in March 2018</p> <p>Ore was first produced from the newly commissioned Jimblebar Hub in late 2013</p> <p>Jimblebar sells ore to the Newman JV proximate to the Jimblebar Hub</p> <p>Production at Western Ridge commenced in FY2022</p>
<b>Mine type &amp; mineralisation style</b>	<p>Open-cut</p> <p>Bedded ore types classified as per host Archaean or Proterozoic banded iron formation, which are Brockman and Marra Mamba; also present is iron-rich detrital material</p>
<b>Power source</b>	<p>Power for all mine operations in the Central and Eastern Pilbara is supplied by BHP's natural gas-fired Yarnima power station</p> <p>Power consumed in port operations is supplied via a contract with APA Group (formerly Alinta)</p>
<b>Processing plants and other available facilities</b>	<p>3 primary crushers, ore handling plant, train loadout, stockyard blending facility and supporting mining hub infrastructure (nominal capacity 71 Mtpa)</p> <p>Production from the Western Ridge deposits will be processed through existing processing facility for Newman operations</p>
<b>Key permit conditions</b>	<p>State Agreement contains conditions set by the Western Australian Government, including requirements for future development proposals; environmental compliance and reporting obligations; closure and rehabilitation considerations; local procurement and community plans/initiatives/investment requirements; payment of rent, taxes and government royalties</p> <p>Tenements granted by the Western Australian Government under the WA Mining Act</p> <p>Key permit conditions include resource reporting, environmental compliance and reporting, rehabilitation considerations and offset payments and payment of lease rentals and royalties</p> <p>Registered Indigenous Land Use Agreement with conditions, including appropriate native title compensation and opportunity sharing; enshrine heritage protections and land access rights; and guarantee certain heritage, environment and consultation processes</p>

**Mine & location**

<b>WAIO</b>	Pilbara region, Western Australia Yarrie Nimingarra Mining Area C South Flank
Mt Goldsworthy joint venture	
<b>Means of access</b>	Private road Yarrie and Nimingarra iron ore transported by Mt Goldsworthy JV-owned rail to Port Hedland (218 km) Mining Area C iron ore transported by Mt Newman JV-owned rail to Port Hedland (360 km) South Flank iron ore transported by overland conveyors (8–16 km) to the Mining Area C processing hub Mt Goldsworthy JV railway spur links Mining Area C and South Flank to Yandi JV's railway spur
<b>Type and amount of ownership</b>	BHP Minerals 85% Mitsui Iron Ore Corporation 7% ITOCHU Minerals and Energy of Australia 8%
<b>Operator</b>	BHP
<b>Title, leases or options and acreage involved</b>	1 mineral lease and 1 mining lease both granted pursuant to the Iron Ore (Goldsworthy – Nimingarra) Agreement Act 1972, expire in 2035, with rights to successive renewals of 21 years each. ML251SA and M263SA – approximately 15,623 hectares  A number of smaller mining leases granted under the WA Mining Act expire in 2026 with rights to successive renewals of 21 years. 5 leases – approximately 2,999 hectares  3 mineral leases granted under the Iron Ore (Mount Goldsworthy) Agreement Act 1964, which expire 2028, with rights to successive renewals of 21 years each  ML235SA, ML249SA and ML281SA – approximately 91,124 hectares
<b>History and stage of property</b>	Production stage  Operations commenced at Mt Goldsworthy in 1966 and at Shay Gap in 1973  Original Goldsworthy mine closed in 1982  Associated Shay Gap mine closed in 1993  Mining at Nimingarra mine ceased in 2007, then continued from adjacent Yarrie area  Production commenced at Mining Area C mine in 2003  Yarrie mine operations were suspended in February 2014  First ore at South Flank commenced in May 2021
<b>Mine type &amp; mineralisation style</b>	Mining Area C, South Flank, Yarrie and Nimingarra are open-cut  Bedded ore types classified as per host Archaean or Proterozoic iron formation, which are Brockman, Marra Mamba and Nimingarra; also present is iron-rich detrital material
<b>Power source</b>	Power for Yarrie and Shay Gap is supplied by their own small diesel generating stations  Power for all remaining mine operations in the Central and Eastern Pilbara is supplied by BHP's natural gas-fired Yarnima power station  Power consumed in port operations is supplied via a contract with APA Group (formerly Alinta)
<b>Processing plants and other available facilities</b>	Mining Area C: 2 primary crushers, 2 ore handling plants, stockyard blending facility and train load out (nominal capacity 64 Mtpa)  South Flank: 2 primary crushers, 1 ore handling plant, stockyard and blending facility and train load out (nominal capacity 80 Mtpa)

<b>Key permit conditions</b>	<p>State Agreements contain conditions set by the Western Australian Government, including requirements for future development proposals; environmental compliance and reporting obligations; closure and rehabilitation considerations; local procurement and community plans/initiatives/investment requirements; payment of rent, taxes and government royalties</p> <p>Tenements granted by the Western Australian Government under the WA Mining Act</p> <p>Key permit conditions include resource reporting, environmental compliance and reporting, rehabilitation considerations and offset payments and payment of lease rentals and royalties</p> <p>Registered Indigenous Land Use Agreements with conditions, including appropriate native title compensation and opportunity sharing; enshrine heritage protections and land access rights; and guarantee certain heritage, environment and consultation processes</p>
<b>Mine &amp; location</b>	
<b>WAIO</b>	Pilbara region, Western Australia
POSMAC joint venture	
<b>Means of access</b>	<p>Private road</p> <p>POSMAC JV sells ore to Mt Goldsworthy JV at Mining Area C</p> <p>Ore is transported via Mt Goldsworthy JV-owned rail and Mt Newman JV-owned rail to Port Hedland</p> <p>Mt Goldsworthy JV railway spur links Mining Area C to Yandi JV's railway spur</p>
<b>Type and amount of ownership</b>	<p>BHP Minerals 65%</p> <p>ITOCHU Minerals and Energy of Australia 8%</p> <p>Mitsui Iron Ore Corporation 7%</p> <p>POS-Ore 20%</p>
<b>Operator</b>	BHP
<b>Title, leases or options and acreage involved</b>	<p>Sublease over part of Mt Goldsworthy Mining Area C mineral lease that expires on the earlier of termination of the mineral lease or the end of the POSMAC JV</p> <p>ML281SA – approximately 56,335 hectares</p>
<b>History and stage of property</b>	<p>Production stage</p> <p>Production commenced in October 2003</p> <p>POSMAC JV sells all ore to Mt Goldsworthy JV at Mining Area C</p>
<b>Mine type &amp; mineralisation style</b>	<p>Open-cut</p> <p>Bedded ore types classified as per host Archaean or Proterozoic iron formation, which is Marra Mamba</p>
<b>Power source</b>	<p>Power for all mine operations in the Central and Eastern Pilbara is supplied by BHP's natural gas-fired Yarnima power station</p> <p>Power consumed in port operations is supplied via a contract with APA Group (formerly Alinta)</p>
<b>Processing plants and other available facilities</b>	POSMAC sells all ore to Mt Goldsworthy JV, which is then processed at Mining Area C
<b>Key permit conditions</b>	Key permit conditions of POSMAC joint venture are captured within the Mount Goldsworthy joint venture key permit conditions outlined above

## Coal mining operations

The following table includes details about our mining operations as at 30 June 2024. It does not include information on the Daunia and Blackwater coal mining operations, which were divested by BMA's owners during the year. While some of the land and tenements related to the Daunia and Blackwater mines is pending transfer following completion in April 2024, the assets are now under Whitehaven Coal's control and operated for their benefit and have been excluded on that basis.

This table should be read in conjunction with OFR 5.1 and the production table and reserves and resources tables in Additional information 4 and 6.

<b>Mine &amp; location</b>	
<b>BHP Mitsubishi Alliance</b>	Bowen Basin, Queensland, Australia Goonyella Riverside Broadmeadow Caval Ridge Peak Downs Saraji and Saraji South mines
Central Queensland Coal Associates joint venture	
<b>Means of access</b>	Public road Coal transported by rail to Hay Point Coal Terminal Distances between the mines and port are between 191 km and 212 km
<b>Type and amount of ownership</b>	BHP 50% Mitsubishi Development 50%
<b>Operator</b>	BMA
<b>Title, leases or options and acreage involved</b>	Mining leases, including undeveloped tenements, have expiry dates ranging up to 2045, renewable for further periods as Queensland Government legislation allows Approximately 79,752 hectares excluding the tenements pending transition to Whitehaven Coal Mining is permitted to continue under the legislation during the renewal application period All required renewal applications were lodged and pending a decision from the Minister
<b>History and stage of property</b>	Production stage Goonyella mine commenced in 1971, merged with adjoining Riverside mine in 1989 Operates as Goonyella Riverside Production commenced at: Peak Downs in 1972 Saraji in 1974 Norwich Park in 1979 Broadmeadow (longwall operations) in 2005 Caval Ridge in 2014 Production at Saraji South (formerly Norwich Park) ceased in May 2012. Since October 2022, limited product has been sourced from Saraji South for processing at Saraji
<b>Mine type &amp; mineralisation style</b>	All open-cut except Broadmeadow (longwall underground) Bituminous coal is mined from the Permian Moranbah Coal measures Products range from premium-quality, low-volatile, high-vitrinite hard coking coal to medium-volatile hard coking coal, to weak coking coal and medium ash thermal coal as a secondary product
<b>Power source</b>	Queensland electricity grid connection is under long-term contracts and energy purchased via Retail Agreements

<b>Processing plants and other available facilities</b>	On-site beneficiation processing facilities Combined nominal capacity of 50 Mtpa
<b>Key permit conditions</b>	Key permit conditions are contained in the various legislation set by the Queensland Government and include conditions relating to carrying out works in accordance with the environmental authority and approved development plans, payment of rents, reporting and payment of royalties. Mining leases granted under the Central Queensland Coal Associates Agreement Act 1968 place an extraction cap of 1,860 Mt
<b>Mine &amp; location</b>	
<b>New South Wales Energy Coal</b>	Approximately 126 km northwest of Newcastle, New South Wales, Australia
Mt Arthur Coal	
<b>Means of access</b>	Public road Coal transported by third-party rail
<b>Type and amount of ownership</b>	BHP 100%
<b>Operator</b>	BHP
<b>Title, leases or options and acreage involved</b>	New South Wales Energy Coal holds 10 mining leases, 2 subleases and 1 exploration licence Total mining leases approximately 8,750 hectares
<b>History and stage of property</b>	Production stage Production commenced in 2002 (previous operations dating to the early 1960s) Approval to expand mining granted in 2010 with an additional area also granted by an approval modification in 2014 Current Development Consent expires in 2026 On 16 June 2022, BHP announced the decision to cease mining at the asset by the end of FY2030 The application to continue mining for an additional 4 years from FY2026 to FY2030 was lodged with the New South Wales Government in September 2023 and is currently under assessment
<b>Mine type &amp; mineralisation style</b>	Open-cut Produces a medium rank bituminous thermal coal
<b>Power source</b>	New South Wales electricity grid connection under a deemed long-term contract and energy purchased via a Retail Agreement
<b>Processing plants and other available facilities</b>	Beneficiation facilities: coal handling, preparation, washing plants Nominal capacity in excess of 23 Mtpa
<b>Key permit conditions</b>	The project approval contains key conditions: (i) it requires MAC to be operated generally in accordance with the environmental assessment; and (ii) permits extraction of up to 36 Mtpa of run of mine coal from underground and open-cut operations, with open-cut extraction limited to 32 Mtpa

## Nickel mining operations

The following table contains additional details of our mining operations. This table should be read in conjunction with OFR 5.1 and the production table and reserves and resources tables in Additional information 4 and 6.

### Mine & location

<b>Nickel West</b>	450 km north of Kalgoorlie, Western Australia
	Mt Keith Mine
	Mt Keith Satellite Mine (Yakabindie)
Mt Keith mine and concentrator	
<b>Means of access</b>	Private road
	Nickel concentrate transported by road to Leinster for drying and on-shipping
<b>Type and amount of ownership</b>	BHP 100%
<b>Operator</b>	BHP
<b>Title, leases or options and acreage involved</b>	Mining leases granted by Western Australian Government
	Key leases expire between 2029 and 2036
	First renewal of 21 years is as a right. Further renewals at government discretion
	Mt Keith mining leases approximately 9,240 hectares
	Mt Keith satellite mining leases approximately 3,835 hectares
<b>History and stage of property</b>	Production stage
	Commissioned in 1995 by WMC
	Acquired in 2005 as part of WMC acquisition
	Mt Keith Satellite Mine contains 2 open-pit mines: Six Mile Well and Goliath, both in full production
	Nickel West operations will be temporarily suspended from October 2024
<b>Mine type &amp; mineralisation style</b>	Open-cut
	Disseminated textured magmatic nickel-sulphide mineralisation associated with a metamorphosed ultramafic intrusion
<b>Power source</b>	On-site third-party gas-fired turbines and renewable solar generation with backup from diesel engine generation
	Contracts expire in December 2038
	Natural gas sourced and transported under separate long-term contracts
<b>Processing plants and other available facilities</b>	Concentration plant with a nominal capacity of 11 Mtpa of ore
<b>Key permit conditions</b>	Use of the land for the purposes set out by the Western Australian Government under granted mining tenements and broadly comprise of submission of detailed mining proposals; payment of royalties, annual rent to the State Government; rates to relevant local governments; compliance with environmental regulations and mine closure requirements and other reporting obligations. Existing mining operations are also subject to an Indigenous Land Use Agreement (ILUA), which includes commitments for payments made to trust accounts; Indigenous employment and business opportunities; heritage and cultural protections



**Mine & location**

<b>Nickel West</b>	375 km north of Kalgoorlie, Western Australia Venus sub-level caving operation B11 block caving operation Camelot open-pit mine Rocky's Reward open-pit mine
Leinster mine complex and concentrator	
<b>Means of access</b>	Public road Nickel concentrate shipped by road and rail to Kalgoorlie Nickel Smelter
<b>Type and amount of ownership</b>	BHP 100%
<b>Operator</b>	BHP
<b>Title, leases or options and acreage involved</b>	Mining leases granted by Western Australian Government Key leases expire between 2025 and 2040 Renewals of principal mineral lease in accordance with State Agreement ratified by the Nickel (Agnew) Agreement Act 1974 Leinster mining leases approximately 6,325 hectares Camelot mining leases approximately 2,353 hectares
<b>History and stage of property</b>	Production stage Production commenced in 1979 Acquired in 2005 as part of WMC acquisition Leinster underground ceased operations in 2013 and recommenced operations in 2016 with Venus sub-level cave now in operation and B11 block cave developing its undercut and draw points Rocky's Reward open-pit mine ceased mining in 2021 Nickel West operations will be temporarily suspended from October 2024
<b>Mine type &amp; mineralisation style</b>	Open-cut and underground Steeply dipping disseminated and massive textured nickel-sulphide mineralisation associated with metamorphosed ultramafic lava flows and intrusions
<b>Power source</b>	On-site third-party gas-fired turbines and renewable solar generation with back up from diesel engine generation Contracts expire in December 2038 Natural gas sourced and transported under separate long-term contracts
<b>Processing plants and other available facilities</b>	Concentration plant with a nominal capacity of 3 Mtpa of ore
<b>Key permit conditions</b>	Use of the land for the purposes set out by the Western Australian Government in the Nickel (Agnew) Agreement Act 1974 broadly comprise of submission of detailed mining proposals and additional proposals; payment of royalties, annual rent to Western Australian Government; rates to relevant local governments; compliance with environmental regulations and mine closure requirements and other reporting obligations. Existing mining operations are also subject to an Indigenous Land Use Agreement (ILUA), which includes commitments for payments made to trust accounts; Indigenous employment and business opportunities; heritage and cultural protections

**Mine & location**

<b>Nickel West</b>	450 km north of Kalgoorlie, Western Australia
Cliffs mine	
<b>Means of access</b>	Private road
	Nickel ore transported by road to Leinster or Mt Keith for further processing
<b>Type and amount of ownership</b>	BHP 100%
<b>Operator</b>	BHP
<b>Title, leases or options and acreage involved</b>	Mining leases granted by Western Australian Government
	Key leases expire between 2025 and 2028
	First renewal of 21 years is as of right. Further renewals at government discretion
	Mining leases approximately 2,675 hectares
<b>History and stage of property</b>	Production stage
	Production commenced in 2008
	Acquired in 2005 as part of WMC acquisition
	Nickel West operations will be temporarily suspended from October 2024
<b>Mine type &amp; mineralisation style</b>	Underground
	Steeply dipping massive textured nickel-sulphide mineralisation associated with metamorphosed ultramafic lava flows
<b>Power source</b>	Supplied from Mt Keith
<b>Processing plants and other available facilities</b>	Mine site
<b>Key permit conditions</b>	Use of the land for the purposes set out by the Western Australian Government under granted mining tenements and broadly comprise of submission of detailed mining proposals; payment of royalties, annual rent to the State Government; rates to relevant local government; compliance with environmental regulations and mine closure requirements and other reporting obligations. Existing mining operations are also subject to an Indigenous Land Use Agreement (ILUA), which includes commitments for payments made to trust accounts; Indigenous employment and business opportunities; heritage and cultural protections

**Mine & location**

<b>West Musgrave Project</b>	Musgrave Province, Western Australia
<b>Means of access</b>	Public road
<b>Type and amount of ownership</b>	BHP 100%
<b>Operator</b>	BHP
<b>Title, leases or options and acreage involved</b>	The Project contemplates 2 copper and nickel deposits (Babel pit and Nebo pit) within the West Musgrave Ranges of Western Australia  M69/149, L69/56, L69/57 and L69/44  Development Envelope of 20,852 hectares
<b>History and stage of property</b>	Scoping studies completed in 2017  Pre-feasibility study completed by OZ Minerals and Cassini Resources Ltd in 2020  Acquired by OZ Minerals in October 2020  Final investment decision in September 2022  Acquired in 2023 as part of OZ Minerals acquisition  West Musgrave Project will be temporarily suspended from October 2024
<b>Mine type &amp; mineralisation style</b>	Open-pit (still in project stage)  Magmatic nickel and copper sulphide
<b>Power source</b>	Long-term power expected to be delivered by an off-grid hybrid power system (wind, solar, battery and thermal generation)
<b>Processing plants and other available facilities</b>	Crushing, vertical roller mill, flotation producing separate nickel and copper concentrates (still in project stage)
<b>Key permit conditions</b>	All key regulatory approvals in place and a Land access agreement signed with the Ngaanyatjarra people to develop 2 copper and nickel deposits (Babel pit and Nebo pit) within the West Musgrave Ranges (including mining, accommodation, an airstrip and processing facilities)  There are a number of strict conditions on cultural heritage, flora and fauna, inland waters and greenhouse gas, including: <ul style="list-style-type: none"> <li>• no more than 3,830 hectares clearing of native vegetation</li> <li>• achieving net zero greenhouse gas emissions by 2040, including up to 60 megawatts (instantaneous load requirement) of fossil fuel electricity generation with the remainder of the power supply to be generated through solar or wind electricity generation</li> <li>• abstraction of up to 7.5 gigalitres of groundwater per annum</li> <li>• compliance with the Cultural Heritage Management Plan, including no direct disturbance of the ethnographic exclusion zones</li> </ul>

**Nickel smelters, refineries and processing plants****Smelter, refinery or processing plant**

<b>Nickel West</b>	56 km south of Kalgoorlie, Western Australia
Kambalda nickel concentrator	
<b>Ownership</b>	BHP 100%
<b>Operator</b>	BHP
<b>Title, leases or options</b>	Mineral leases granted by Western Australian Government  Key leases expire in 2028  Mining leases approximately 242 hectares

<b>Key permit conditions</b>	Use of the land for the purposes set out by the Western Australian Government under granted mining tenements and broadly comprise of submission of detailed mining proposals; payment of royalties, annual rent to the State Government; rates to relevant local government; compliance with environmental regulations and mine closure requirements and other reporting obligations
<b>Product</b>	Concentrate containing approximately 13% nickel
<b>Power source</b>	On-site third-party gas-fired turbines supplemented by access to grid power
	Contracts expire in December 2038
	Natural gas sourced and transported under separate long-term contracts
<b>Nominal production capacity</b>	1.6 Mtpa ore
	Nickel sourced through ore tolling and concentrate purchase arrangements with third parties in Kambalda and outer regions
<b>Smelter, refinery or processing plant</b>	
<b>Nickel West</b>	Kalgoorlie, Western Australia
	Kalgoorlie nickel smelter
<b>Ownership</b>	BHP 100%
<b>Operator</b>	BHP
<b>Title, leases or options</b>	Freehold title over the property
<b>Key permit conditions</b>	
<b>Product</b>	Matte containing approximately 65% nickel
<b>Power source</b>	On-site third-party gas-fired turbines supplemented by access to grid power
	Contracts expire in December 2038
	Natural gas sourced and transported under separate long-term contracts
<b>Nominal production capacity</b>	110 ktpa nickel metal in matte
<b>Smelter, refinery or processing plant</b>	
<b>Nickel West</b>	30 km south of Perth, Western Australia
	Kwinana nickel refinery
<b>Ownership</b>	BHP 100%
<b>Operator</b>	BHP
<b>Title, leases or options</b>	Freehold title over the property
<b>Key permit conditions</b>	
<b>Product</b>	London Metal Exchange grade nickel briquettes, nickel powder
	Also intermediate products, including copper sulphide, cobalt-nickel-sulphide, ammonium sulphate
	Nickel sulphate containing approximately 22% nickel
<b>Power source</b>	Power is sourced from the local grid, which is supplied under a retail contract, supplemented by a Power Purchase Agreement with Merredin Solar Farm for 50% of its output
<b>Nominal production capacity</b>	82.5 ktpa nickel metal in powder, briquettes and nickel sulphate (with approval to increase up to 90 ktpa)
	99 kt–100 kt nickel sulphate (approximately 22 kt–24 kt nickel)

## Copper South Australia

### Copper mining operations

The following table contains additional details of our mining operations. This table should be read in conjunction with OFR 5.1 and 5.2, and the production table and reserves and resources tables in Additional information 4 and 6.

<b>Mine &amp; location</b>	
<b>Olympic Dam</b>	560 km northwest of Adelaide, South Australia
<b>Means of access</b>	Public road
	Copper cathode trucked to ports
	Uranium oxide transported by road to ports
	Gold bullion transported by road and plane
<b>Type and amount of ownership</b>	BHP 100%
<b>Operator</b>	BHP
<b>Title, leases or options and acreage involved</b>	Mining lease granted by South Australian Government expires in 2036
	Approximately 17,788 hectares
	Right of extension for 50 years (subject to remaining mine life)
<b>History and stage of property</b>	Production stage
	Acquired in 2005 as part of Western Mining Corporation (WMC) acquisition
	Copper production began in 1988
	Nominal milling capacity raised to 9 Mtpa in 1999
	Optimisation project completed in 2002
	New copper solvent extraction plant commissioned in 2004
	Major smelter maintenance campaigns completed in 2017 and 2022
<b>Mine type &amp; mineralisation style</b>	Underground
	Large poly-metallic deposit of iron oxide-copper-uranium-gold mineralisation
<b>Power source</b>	Electricity transmitted via BHP's 275 kV power line from Port Augusta and ElectraNet's system upstream of Port Augusta
	Power is sourced from the local grid, which is supplied under a retail contract, currently supplemented by Power Purchase Agreement with Iberdrola
<b>Processing plants and other available facilities</b>	Underground automated train and trucking network feeding crushing, storage and ore hoisting facilities
	2 grinding circuits
	Nominal milling capacity of 11 Mtpa
	Flash furnace produces copper anodes, which are then refined to produce copper cathodes
	Electrowon copper cathode and uranium oxide concentrate produced by leaching and solvent extracting flotation tailings
	Gold cyanide leach circuit and gold room producing gold bullion
<b>Key permit conditions</b>	The Roxby Downs (Indenture Ratification) Act 1982 (Indenture Act) applies to Olympic Dam's operations. It contains conditions from the South Australian Government, including relating to the protection and management of the environment; water; closure and rehabilitation considerations; local procurement and community plans/initiatives/project commitments; and payment of royalties. Olympic Dam also holds other relevant approvals and tenements granted by the South Australian Government, including under the Mining Act 1971 (SA)

<b>Mine &amp; location</b>	The Gawler Craton, South Australia, approximately 160 km north of Port Augusta
<b>Carrapateena</b>	
<b>Means of access</b>	60 km private access road
	Copper concentrate trucked to ports
<b>Type and amount of ownership</b>	BHP 100%
<b>Operator</b>	BHP
<b>Title, leases or options and acreage involved</b>	The Carrapateena Project holds a mining lease (ML 6471) and 5 miscellaneous purposes licences (MPL 149, 152, 153, 154 and 156), which were granted by the South Australian Government and expire in January 2039, with the exception of MPL 149 which expires in July 2038
	Approximately 44,144 hectares in size across all 6 tenements
	An application for tenement extensions can be made within 6 months of the tenement expiry date
<b>History and stage of property</b>	2011 – OZ Minerals acquired Carrapateena exploration project
	2014 – Pre-feasibility study completed
	2016 – Carrapateena scoping study completed
	2017 – Feasibility study updated
	2017 – Works on enabling infrastructure commenced
	2018 – Project approvals completed
	2018 – Construction commenced
	2019 – Construction completed
	2019 – First saleable concentrate produced
	2019 – Block Cave expansion pre-feasibility study commenced
	2020 – 4.25 Mtpa ramp up achieved
	2020 – Block Cave expansion pre-feasibility study completed
	2020 – Block Cave expansion approved
	2020 – New 270 km transmission line to Prominent Hill via Carrapateena commissioned
	2020 – Early works on Western Access Road commenced
	2021 – Block Cave expansion early works underway
	2022 – Cave propagated to surface
	2023 – Acquired as part of OZ Minerals acquisition
	2024 – Commissioning of Crusher Station 2
<b>Mine type &amp; mineralisation style</b>	Underground
	Iron oxide copper gold deposit
<b>Power source</b>	Electricity transmitted via private power line operated under a Build Own Operate Maintain (BOOM) agreement with ElectraNet
	Power purchased via Retail Agreement
<b>Processing plants and other available facilities</b>	Conventional crushing, grinding and flotation on mine site
	Nominal milling capacity of 5.5 Mt
<b>Key permit conditions</b>	The SA Mining Act and associated Mining Regulations 2020 (SA) apply to the Carrapateena Project. Each tenement document (either ML or MPL) in conjunction with the operation's Program for Environment Protection and Rehabilitation (PEPR) outlines the conditions from the South Australian Government that must be complied with including those relating to the protection and management of the environment, water, closure and rehabilitation
	The Carrapateena Project is also approved by the Federal Government under the Environment Protection and Biodiversity Conservation Act 1999 (EPBC Act) and as such has further conditions regarding nationally threatened flora and fauna species

<b>Mine &amp; location</b>	
<b>Prominent Hill</b>	650 km northwest of Adelaide, 130 km southeast of the town of Coober Pedy
<b>Means of access</b>	Mine access road (45 km off Stuart Highway)
	Copper concentrate (containing gold and silver) trucked to Wirrida Railway siding via dedicated Concentrate Export Road
<b>Type and amount of ownership</b>	BHP 100%
<b>Operator</b>	BHP
<b>Title, leases or options and acreage involved</b>	Mining lease ML 6228 granted by South Australian Government expires in August 2041 Miscellaneous purpose licences (MPL 81, 82, 83, 84, 91, 93, 94 96, 97, 101, 112 to 117 and 119 to 122) and extractive mineral leases (EML 6234, 6236 to 6242, 6278 to 6296, 6299 to 6301) which were granted by the South Australian Government and expire in August 2041 Approximately 11,401 hectares across all 51 tenements
<b>History and stage of property</b>	2009 – Malu open-pit mine commissioned 2012 – Ankata underground mine expansion commissioned 2015 – Malu underground mine expansion commissioned 2017 – Expansion of the underground operation with new northern decline (Liru) 2018 – Malu open-pit mine safely closed after more than 100 Mt of ore was mined over 10 years 2019 – Underground ramp up to 4.0 Mt 2019 – Prominent Hill expansion study commenced 2021 – Wira Shaft Mine expansion investment approved 2022 – Decision to increase the electric hoisting shaft’s capacity from 6 Mtpa to 6.5 Mtpa 2023 – Acquired as part of OZ Minerals acquisition
<b>Mine type &amp; mineralisation style</b>	Underground Iron oxide copper gold deposit
<b>Power source</b>	SA power grid via a high voltage power transmission line operated under a Build Own Operate Maintain agreement Power purchased via Retail Agreement
<b>Processing plants and other available facilities</b>	Conventional crushing, semi-autogenous grinding (SAG) and ball mill grinding circuit and flotation processing plant on site Nameplate capacity of 10 Mtpa
<b>Key permit conditions</b>	MPEPR2022/137 Program for Environment Protection and Rehabilitation for Mineral Lease (ML) 6228 and Associated Extractive Minerals Leases and Miscellaneous Purpose Licences Department for Environment and Water: Water Licences 396811 and 396809 Environment Protection Authority Licence 22764 Environment Protection Authority Licence 51429: Licence to Carry out Mining or Mineral Processing pursuant to Radiation Protection and Control Act 2021

## Minerals Americas

### Copper mining operations

The following table contains additional details of our mining operations. This table should be read in conjunction with OFR 5.3 and the production table and reserves and resources tables in Additional information 4 and 6.

<b>Mine &amp; location</b>	Atacama Desert 170 km southeast of Antofagasta, Chile
<b>Means of access</b>	Private road available for public use Copper cathode transported by rail to ports at Antofagasta and Mejillones Copper concentrate transported by Escondida-owned pipelines to its Coloso port facilities
<b>Type and amount of ownership</b>	BHP 57.5% Rio Tinto 30% JECO Corporation consortium comprising Mitsubishi, JX Nippon Mining and Metals 10% JECO 2 Ltd 2.5%
<b>Operator</b>	BHP
<b>Title, leases or options and acreage involved</b>	Mining concession from Chilean Government valid indefinitely (subject to payment of annual fees) Mining concessions (exploitation) approximately 380,000 hectares
<b>History and stage of property</b>	Production stage Original construction completed and production commenced in 1990 Start of operations of the third concentrator plant in 2015 Inauguration of Escondida Water Supply desalination plant (CY2018) and its extension (CY2019)
<b>Key permit conditions</b>	Mining companies in Chile must obtain environmental approvals for their projects, issued by the Environmental Assessment Service (SEA), in order to operate Depending on the particular characteristics and/or extension of the relevant project to be assessed, approvals can be obtained following a full Environmental Impact Study (EIA) or after a less complex Environmental Impact Declaration (DIA) Mining companies are required to pay an annual fee for each mining concession
<b>Mine type &amp; mineralisation style</b>	2 open-cut pits: Escondida and Escondida Norte Escondida and Escondida Norte mineral deposits are adjacent but distinct supergene enriched porphyry copper deposits
<b>Power source</b>	Electricity sourced from 100% renewable sources and certified by the Chilean Electricity Authority (Coordinador Eléctrico Nacional – CEN) Renewable power purchase agreements (PPAs) with third parties supply approximately 99% of Escondida electricity needs with the balance supplied by Tamakaya SpA (100% owned by BHP) Escondida-owned transmission lines connect to Chile's northern power grid
<b>Processing plants and other available facilities</b>	Crushing facilities feed concentrator and leaching processes 3 concentrator plants produce copper concentrate from sulphide ore by flotation extraction process (by-products: gold and silver) 2 solvent extraction and electrowinning plants produce copper cathode Nominal capacity: 422 ktpd (nominal milling capacity) and 350 ktpa copper cathode (nominal capacity of tank house) 2 x 168 km concentrate pipelines, 167 km water pipeline Port facilities at Coloso, Antofagasta Desalinated water plant (total water capacity of 3,800 litres per second)



<b>Mine &amp; location</b> <b>Pampa Norte Spence</b>	Atacama Desert 162 km northeast of Antofagasta, Chile
<b>Means of access</b>	Public road Copper cathode transported by rail to ports at Mejillones and Antofagasta Copper concentrate transported by rail or trucks to port in Mejillones Molybdenum concentrate is transported by trucks
<b>Type and amount of ownership</b>	BHP 100%
<b>Operator</b>	BHP
<b>Title, leases or options and acreage involved</b>	Mining concession from Chilean Government valid indefinitely (subject to payment of annual fees) Mining concessions (exploitation): approximately 44,000 hectares
<b>History and stage of property</b>	Production stage First copper produced in 2006 Spence Growth Option (i.e. new 95 ktpd copper concentrator and molybdenum plants) produced first copper in December 2020 and first molybdenum in April 2022
<b>Key permit conditions</b>	Mining companies in Chile must obtain environmental approvals for their projects, issued by the Environmental Assessment Service (SEA), in order to operate Depending on the particular characteristics and/or extension of the relevant project to be assessed, approvals can be obtained following a full Environmental Impact Study (EIA) or after a less complex Environmental Impact Declaration (DIA) Mining companies are required to pay an annual fee for each mining concession
<b>Mine type &amp; mineralisation style</b>	Open-cut Enriched and oxidised porphyry copper deposit containing in situ copper oxide mineralisation that overlies a near-horizontal sequence of supergene sulphides, transitional sulphides and finally primary (hypogene) sulphide mineralisation
<b>Power source</b>	Electricity sourced from 100% renewable sources and certified by the Chilean Electricity Authority (Coordinador Eléctrico Nacional – CEN) Renewable power purchase agreements (PPAs) with third parties supply most of Spence electricity needs. The remainder is supplied by Tamakaya SpA (100% owned by BHP) Spence-owned transmission lines connect to Chile's northern power grid
<b>Processing plants and other available facilities</b>	Crushing facilities feed concentrator and leaching processes 1 copper concentrator plant with 95 ktpd capacity (by-products: gold and silver), molybdenum plant and a 1,000 litres per second desalinated water plant under a Build Own Operate Transfer (BOOT) agreement Dynamic leach pads, solvent extraction and electrowinning plant Nominal capacity of tank house: 200 ktpa copper cathode

<b>Mine &amp; location</b>	Atacama Desert 120 km east of Iquique, Chile
<b>Means of access</b>	Public road Copper cathode trucked to port at Iquique
<b>Type and amount of ownership</b>	BHP 100%
<b>Operator</b>	BHP
<b>Title, leases or options and acreage involved</b>	Mining concession from Chilean Government valid indefinitely (subject to payment of annual fees) Transitioned to care and maintenance in December 2023. Mining concessions (exploitation): approximately 34,000 hectares
<b>History and stage of property</b>	Production stage Commercial production commenced in 1994 Expansions in 1996 and 1998 Cerro Colorado entered temporary care and maintenance in December 2023
<b>Key permit conditions</b>	Mining companies in Chile must obtain environmental approvals for their projects, issued by the Environmental Assessment Service (SEA), in order to operate  Depending on the particular characteristics and/or extension of the relevant project to be assessed, approvals can be obtained following a full Environmental Impact Study (EIA) or after a less complex Environmental Impact Declaration (DIA)  Mining companies are required to pay an annual fee for each mining concession  Mining companies in Chile that enter a care and maintenance period must obtain approval of a Temporary Closure Plan, sectorial permit, from Sernageomin (Mining Authority). This permit is initially granted for a period of 2 years and is renewable for an additional period of up to 3 years
<b>Mine type &amp; mineralisation style</b>	Open-cut  Enriched and oxidised porphyry copper deposit containing in situ copper oxide mineralisation that overlies a near-horizontal sequence of supergene sulphides, transitional sulphides and finally primary (hypogene) sulphide mineralisation
<b>Power source</b>	Electricity purchased from external vendors
<b>Processing plants and other available facilities</b>	Crushing facilities, dynamic leach pads, solvent extraction plant, electrowinning plant Nominal capacity of tank house: 130 ktpa copper cathode

**Mine & location****Antamina**

Andes mountain range, Peru

Mine: San Marcos – Ancash, 270 km northeast of Lima

Port: Huarney – Ancash, 300 km north of Lima

**Means of access**

Public road

Copper and zinc concentrates transported by Antamina-owned pipeline to its Punta Lobitos port

Molybdenum and lead/bismuth concentrates transported by truck

**Type and amount of ownership**

BHP 33.75%

Glencore 33.75%

Teck 22.5%

Mitsubishi 10%

**Operator**

Compañía Minera Antamina S.A.

**Title, leases or options and acreage involved**

Mining rights from Peruvian Government held indefinitely, subject to payment of annual fees and supply of information on investment and production

Total acreage: approximately 6,600 hectares

**History and stage of property**

Production stage

Commercial production commenced in 2001

**Key permit conditions**

During FY2024, the National Environmental Certification Service (SENACE) approved Antamina's Modification of the Environmental Impact Assessment (MEIA), enabling Antamina to extend its life from CY2028 to CY2036, maintaining annual production volumes within its current operational footprint

**Mine type & mineralisation style**

Open-cut

Zoned porphyry and skarn deposit with central copper dominated ores and an outer band of copper-zinc dominated ores

**Power source**

Contracts with individual power producers

**Processing plants and other available facilities**

Primary crusher, concentrator, copper and zinc flotation circuits, bismuth/moly cleaning circuit

Nominal milling capacity 145 ktpd

304 km concentrate pipeline

Port facilities at Huarney

**Mine & location**

<b>Resolution</b>	Superior/Project: Pinal – Arizona, 100 km east of Phoenix, United States
<b>Means of access</b>	Public road
<b>Type and amount of ownership</b>	BHP 45%
	Rio Tinto 55% (operator)
<b>Operator</b>	Resolution Copper Mining LLC
<b>Title, leases or options and acreage involved</b>	Private land, patented and unpatented mining claims
	Total acreage: approximately 46,000 acres
<b>History and stage of property</b>	Exploration stage
	The Resolution deposit is within the footprint of and adjacent to the historical Magma Copper Mine
	The Resolution non-operated joint venture (NOJV) was formed in 2004 with Rio Tinto as operator
<b>Key permit conditions</b>	The Resolution Copper Project is subject to a federal permitting process pursuant to the National Environmental Policy Act (NEPA) and other US legislation, including requirements for consultation, coordination and collaboration with Native American Tribes
	The NEPA process is led by the US Forest Service
	The Resolution Copper Project is also required to obtain several state and local permits, including air quality and groundwater protection permits
<b>Mine type &amp; mineralisation style</b>	Underground
	Porphyry copper and molybdenum deposit
<b>Power source</b>	115 kV power lines to East and West Plant sites with supply contract with Salt River Project
<b>Processing plants and other available facilities</b>	Water treatment and reverse osmosis plant, 2 active underground shafts with associated support infrastructure, including hoisting, ventilation and cooling, and a rail corridor connecting the site to the national rail network

## Iron ore mining operations

The following table contains additional details of our mining operations. This table should be read in conjunction with OFR 5.3 and the production table and reserves and resources tables in Additional information 4 and 6.

### Mine & location

<b>Samarco</b>	Southeast Brazil Samarco Mine: Mariana – Minas Gerais, 130 km southeast of Belo Horizonte Port: Anchieta – Espírito Santo, 520 km east of Belo Horizonte
<b>Means of access</b>	Public road Iron ore pellets exported via Samarco port facilities – Ubu Port
<b>Type and amount of ownership</b>	BHP Brasil 50% Vale S.A. 50%
<b>Operator</b>	Samarco Mineração S.A.
<b>Title, leases or options and acreage involved</b>	Mining concessions granted by Brazilian Government subject to compliance with the mine plan Samarco recommenced iron ore pellet production in December 2020, having met licensing requirements to restart operations at its Germano complex in Minas Gerais and its Ubu complex in Espírito Santo Mining rights for approximately 1,605 hectares
<b>History and stage of property</b>	Production stage Production began at Germano mine in 1977 and at Alegria complex in 1992 Second pellet plant built in 1997 Third pellet plant, second concentrator and second pipeline built in 2008 Fourth pellet plant, third concentrator and third pipeline built in 2014
<b>Key permit conditions</b>	Samarco has an operating licence (LOC – Corrective Operating License) obtained for the return of operations For the continuity of operations, it has a long-term licensing plan that includes expansion of the mining area and new structures for the disposal of waste and tailings
<b>Mine type &amp; mineralisation style</b>	Open-cut Itabirites (metamorphic quartz-hematite rock) and friable hematite ores
<b>Power source</b>	Samarco holds interests in 2 hydroelectric power plants, which supply part of its electricity needs. The remainder is purchased from the free (non-regulated) electricity market
<b>Processing plants and other available facilities</b>	Facilities currently operating include 1 concentrator, a system of tailings disposal combining a confined pit and filtration plant for dry stacking of sandy tailings, beneficiation plants, pipelines, 1 pellet plant and port facilities Following Samarco’s plan to gradually restart operations, the restart of a second concentrator and pelletising plant, and expansion of the existing filtration plant are expected to be in operation by early CY2025

## Other mining operations

The following table contains additional details of our mining operations. This table should be read in conjunction with OFR 5.3 and the production table and reserves and resources tables in Additional information 4 and 6.

### Mine & location

<b>Jansen (under construction)</b>	Province of Saskatchewan, approximately 140 km east of Saskatoon, Canada
<b>Means of access</b>	Public road  Muriate of Potash (MOP) to be transported by rail to the port at Westshore Terminal in Delta, British Columbia, Canada
<b>Type and amount of ownership</b>	BHP 100%
<b>Operator</b>	BHP
<b>Title, leases or options and acreage involved</b>	The total area of the Jansen lease is approximately 1,120 square km  All surface lands have been acquired
<b>History and stage of property</b>	Development stage  Stage 1 is currently under construction  Stage 2 was sanctioned and execution commenced in FY2024
<b>Key permit conditions</b>	The Jansen Project received Ministerial approval under the Saskatchewan Environmental Assessment Act  Following approval, various federal, provincial and municipal permits have been or will be obtained for construction and operation of facilities
<b>Mine type &amp; mineralisation style</b>	Underground  The Lower Patience Lake (LPL) sub-member is the potash horizon targeted for Jansen. The LPL sub-member is a bedded evaporite composed of sylvite (KCl), halite (NaCl) with variable amounts of disseminated insoluble and clay seams
<b>Power source</b>	Electricity transmitted via BHP's 230 kV substation and upstream provincial power utility system
<b>Processing plants and other available facilities</b>	Mill, buildings and other facilities and infrastructure are under construction

**Mine & location****Pedra Branca**

Água Azul do Norte, Pará

Approximately 160 km from Marabá and 900 km from Belém in the state of Pará, Brazil

**Means of access**

Public road

From Água Azul to Parauapebas from highway (PA 150) to be transported by train to the port of Itaqui in São Luiz, state of Maranhão, Brazil

**Type and amount of ownership**

BHP 100%

**Operator**

OZ Minerals Brasil

**Title, leases or options and acreage involved**

The property belongs to OZ Minerals Brasil

**History and stage of property**

2018 – OZ Minerals acquired mine operator Avanco Resources – including projects in the Carajás Copper Region and the Gurupi Greenstone Belt

2019 – Construction commenced

2020 – First developmental ore sent to Antas for processing

2021 – Commencement of underground mining in Pedra Branca and inaugural resource identification announcement in Santa Lúcia

2022 – Ramped up to full production

2023 – Acquisition of OZ Minerals by BHP

2024 – Santa Lucia project permitting process granted by SEMAS—environment Agency of Pará State

**Key permit conditions**

The closure plan to be updated in accordance with requirement from ANM (n° 68/2021) when the life of mine changes

Annual environmental report (RIAA) required to be submitted in accordance with the activities developed for the mine production

**Mine type & mineralisation style**

Underground

Iron oxide copper gold deposit. High grade zones of semi-massive and breccia style mineralisation. Dominant chalcopyrite (copper mineralisation)

**Power source**

3MW required to operate mine coming from power lines from north of state (Tucuruí hydroelectric plant). The expansion required is in progress with new lines to achieve 7MW

**Processing plants and other available facilities**

The material is processed in Antas Norte Plant located in the municipality of Curionópolis

Plant capacity is 800 ktpa and the tailings are deposited in the exhausted mine existing on site

Mill, buildings and other facilities and infrastructure are in the Curionópolis municipality

## 2 Financial information summary

We prepare our Consolidated Financial Statements in accordance with International Financial Reporting Standards (IFRS), as issued by the International Accounting Standards Board. We publish our Consolidated Financial Statements in US dollars. All Consolidated Income Statement, Consolidated Balance Sheet and Consolidated Cash Flow Statement information below has been derived from audited Financial Statements. For more information refer to the Financial Statements.

Some information in this section has been presented on a Continuing operations basis to exclude the contribution from Discontinued operations.

### Year ended 30 June

US\$M	2024	2023	2022	2021	2020
<b>Consolidated Income Statement (Financial Statements 1.1)</b>					
Revenue	55,658	53,817	65,098	56,921	38,924
Profit from operations	17,537	22,932	34,106	25,515	13,683
Profit after taxation from Continuing operations	9,601	14,324	22,400	13,676	8,628
Profit/(loss) after taxation from Discontinued operations	–	–	10,655	(225)	108
Profit after taxation from Continuing and Discontinued operations attributable to BHP shareholders (Attributable profit)	7,897	12,921	30,900	11,304	7,956
Profit after taxation from Continuing operations attributable to BHP shareholders	7,897	12,921	20,245	11,529	7,848
Dividends per ordinary share – paid during the period (US cents)	152.0	265.0	350.0	156.0	143.0
Dividends per ordinary share – determined in respect of the period (US cents)	146.0	170.0	325.0	301.0	120.0
In specie dividend on merger of Petroleum with Woodside (US cents)	–	–	386.4	–	–
Basic earnings per ordinary share (US cents) <sup>1</sup>	155.8	255.2	610.6	223.5	157.3
Diluted earnings per ordinary share (US cents) <sup>1</sup>	155.5	254.7	609.3	223.0	157.0
Basic earnings from Continuing operations per ordinary share (US cents) <sup>1</sup>	155.8	255.2	400.0	228.0	155.2
Diluted earnings from Continuing operations per ordinary share (US cents) <sup>1</sup>	155.5	254.7	399.2	227.5	154.8
<b>Number of ordinary shares (million)<sup>1</sup></b>					
- At period end	5,072	5,066	5,062	5,058	5,058
- Weighted average	5,068	5,064	5,061	5,057	5,057
- Diluted	5,077	5,073	5,071	5,068	5,069
<b>Consolidated Balance Sheet (Financial Statements 1.3)<sup>2</sup></b>					
Total assets	102,362	101,296	95,166	108,927	105,733
Net assets	49,120	48,530	48,766	55,605	52,175
Share capital (including share premium)	4,899	4,737	4,638	2,686	2,686
Total equity attributable to BHP shareholders	44,811	44,496	44,957	51,264	47,865
<b>Consolidated Cash Flow Statement (Financial Statements 1.4)</b>					
Net operating cash flows <sup>3</sup>	20,665	18,701	32,174	27,234	15,706
Capital and exploration expenditure <sup>4,5</sup>	9,273	7,083	7,545	7,120	7,640
<b>Other financial information (OFR 10)</b>					
Net debt <sup>5</sup>	9,120	11,166	333	4,121	12,044
Underlying attributable profit <sup>5</sup>	13,660	13,420	23,815	17,077	9,060
Underlying attributable profit – Continuing operations <sup>5</sup>	13,660	13,420	21,319	16,985	8,948
Underlying EBITDA <sup>5</sup>	29,016	27,956	40,634	35,073	19,870
Underlying EBIT <sup>5</sup>	23,631	22,820	34,436	29,853	15,130
Underlying basic earnings per share (US cents) <sup>5</sup>	269.5	265.0	470.6	337.7	179.2
Underlying basic earnings per share – Continuing operations (US cents) <sup>5</sup>	269.5	265.0	421.2	335.9	176.9
Underlying return on capital employed (per cent) <sup>5</sup>	27.2	28.8	48.7	32.5	16.9

1. For more information on earnings per share refer to Financial Statements note 7 'Earnings per share'.

2. The Consolidated Balance Sheet for comparative periods includes the associated assets and liabilities in relation to Blackwater and Daunia mines (disposed in FY2024), Petroleum (merger with Woodside in FY2022), BMC and Cerrejón (both disposed in FY2022) as IFRS 5 'Non-current Assets Held for Sale and Discontinued Operations' does not require the Consolidated Balance Sheet to be restated for comparative periods.

3. Net operating cash flows are after dividends received, net interest paid, proceeds and settlements of cash management related instruments, net taxation paid and includes Net operating cash flows from Discontinued operations.

4. Capital and exploration and evaluation expenditure is presented on a cash basis and represents purchases of property, plant and equipment plus exploration and evaluation expenditure from the Consolidated Cash Flow Statement and includes purchases of property, plant and equipment plus exploration and evaluation expenditure from Discontinued operations. For more information refer to Financial Statements note 28 'Discontinued operations'. Exploration and evaluation expenditure is capitalised in accordance with our accounting policies, as set out in Financial Statements note 11 'Property, plant and equipment'.

5. We use non-IFRS financial information to reflect the underlying performance of the Group. Underlying attributable profit, Underlying basic earnings per share and Underlying return on capital employed includes Continuing and Discontinued operations. Refer to OFR 10 for a reconciliation of non-IFRS financial information to their respective IFRS measure. Refer to OFR 10.1 for the definition and method of calculation of non-IFRS financial information. Refer to Financial Statements note 21 'Net debt' for the composition of Net debt.



### 3 Financial information by commodity

Management believes the following financial information presented by commodity provides a meaningful indication of the underlying financial performance of the assets, including equity accounted investments, of each reportable segment. Information relating to assets that are accounted for as equity accounted investments is shown to reflect BHP's share, unless otherwise noted, to provide insight into the drivers of these assets.

For the purposes of this financial information, segments are reported on a statutory basis in accordance with IFRS 8/AASB 8 'Operating Segments'. The tables for each commodity include an 'adjustment for equity accounted investments' to reconcile the equity accounted results to the statutory segment results.

For a reconciliation of non-IFRS financial information to respective IFRS measures and an explanation as to the use of Underlying EBITDA in assessing our performance refer to OFR 10. For the definition and method of calculation of non-IFRS financial information refer to OFR 10.1. For more information as to the statutory determination of our reportable segments refer to Financial Statements note 1 'Segment reporting'.

Year ended 30 June 2024	Revenue <sup>2</sup>	Underlying EBITDA <sup>3</sup>	Underlying EBIT <sup>3</sup>	Exceptional items <sup>4</sup>	Net operating assets <sup>3</sup>	Capital expenditure	Exploration gross	Exploration to profit <sup>5</sup>
<b>US\$M</b>								
<b>Copper</b>								
<i>Escondida</i>	10,013	5,759	4,821		13,113	1,806		
<i>Pampa Norte<sup>6</sup></i>	2,375	896	468		4,843	721		
<i>Antamina<sup>7</sup></i>	1,478	968	746		1,498	437		
<i>Copper South Australia<sup>8</sup></i>	4,085	1,568	928		16,498	1,048		
<i>Other<sup>7</sup></i>	72	(176)	(228)		416	136		
Total Copper from Group production	18,023	9,015	6,735	–	36,368	4,148		
<i>Third-party products</i>	2,021	74	74	–	–	–		
Total Copper	20,044	9,089	6,809	–	36,368	4,148	216	215
<i>Adjustment for equity accounted investments<sup>7</sup></i>	(1,478)	(525)	(285)	–	–	(437)	(3)	(2)
<b>Total Copper statutory result</b>	<b>18,566</b>	<b>8,564</b>	<b>6,524</b>	<b>–</b>	<b>36,368</b>	<b>3,711</b>	<b>213</b>	<b>213</b>
<b>Iron Ore</b>								
<i>Western Australia Iron Ore</i>	27,805	18,964	16,902		20,597	2,026		
<i>Samarco<sup>9</sup></i>	–	–	–		(6,606)	–		
<i>Other</i>	122	(48)	(74)		(179)	7		
Total Iron Ore from Group production	27,927	18,916	16,828	(3,066)	13,812	2,033		
<i>Third-party products</i>	25	(3)	(3)	–	–	–		
Total Iron Ore	27,952	18,913	16,825	(3,066)	13,812	2,033	86	41
<i>Adjustment for equity accounted investments</i>	–	–	–	–	–	–	–	–
<b>Total Iron Ore statutory result</b>	<b>27,952</b>	<b>18,913</b>	<b>16,825</b>	<b>(3,066)</b>	<b>13,812</b>	<b>2,033</b>	<b>86</b>	<b>41</b>
<b>Coal</b>								
<i>BHP Mitsubishi Alliance<sup>10</sup></i>	5,873	1,914	1,394		6,725	533		
<i>New South Wales Energy Coal<sup>11</sup></i>	1,945	502	408		(211)	100		
<i>Other</i>	–	(27)	(50)		(42)	14		
Total Coal from Group production	7,818	2,389	1,752	880	6,472	647		
<i>Third-party products</i>	–	–	–	–	–	–		
Total Coal	7,818	2,389	1,752	880	6,472	647	14	3
<i>Adjustment for equity accounted investments<sup>11</sup></i>	(152)	(99)	(75)	–	–	(1)	–	–
<b>Total Coal statutory result</b>	<b>7,666</b>	<b>2,290</b>	<b>1,677</b>	<b>880</b>	<b>6,472</b>	<b>646</b>	<b>14</b>	<b>3</b>
<b>Group and unallocated items</b>								
<i>Potash</i>	–	(255)	(257)		6,138	1,090	1	1
<i>Western Australia Nickel<sup>12</sup></i>	1,473	(302)	(374)		(6)	1,254	50	58
<i>Other<sup>13</sup></i>	1	(194)	(764)		(1,421)	82	93	93
Total Group and unallocated items	1,474	(751)	(1,395)	(3,908)	4,711	2,426	144	152
Inter-segment adjustment	–	–	–	–	–	–	–	–
<b>Total Group</b>	<b>55,658</b>	<b>29,016</b>	<b>23,631</b>	<b>(6,094)</b>	<b>61,363</b>	<b>8,816</b>	<b>457</b>	<b>409</b>

Year ended 30 June 2023 US\$M	Revenue <sup>2</sup>	Underlying EBITDA <sup>3</sup>	Underlying EBIT <sup>3</sup>	Exceptional items <sup>4</sup>	Net operating assets <sup>3</sup>	Capital expenditure	Exploration gross	Exploration to profit
<b>Copper</b>								
<i>Escondida</i>	8,847	4,934	4,070		12,207	1,351		
<i>Pampa Norte</i> <sup>6</sup>	2,491	754	244		4,487	647		
<i>Antamina</i> <sup>7</sup>	1,468	998	824		1,430	374		
<i>Copper South Australia</i> <sup>8</sup>	2,806	703	251		15,782	641		
<i>Other</i> <sup>7</sup>	20	(209)	(228)		323	59		
Total Copper from Group production	15,632	7,180	5,161	–	34,229	3,072		
<i>Third-party products</i>	1,863	18	18	–	–	–		
Total Copper	17,495	7,198	5,179	–	34,229	3,072	151	148
<i>Adjustment for equity accounted investments</i> <sup>7</sup>	(1,468)	(545)	(369)	–	–	(374)	(6)	(3)
Total Copper statutory result	16,027	6,653	4,810	–	34,229	2,698	145	145
<b>Iron Ore</b>								
<i>Western Australia Iron Ore</i>	24,678	16,660	14,663		20,438	1,956		
<i>Samarco</i> <sup>9</sup>	–	–	–		(3,382)	–		
<i>Other</i>	113	33	9		(100)	10		
Total Iron Ore from Group production	24,791	16,693	14,672	176	16,956	1,966		
<i>Third-party products</i>	21	(1)	(1)	–	–	–		
Total Iron Ore	24,812	16,692	14,671	176	16,956	1,966	96	52
<i>Adjustment for equity accounted investments</i>	–	–	–	–	–	–	–	–
Total Iron Ore statutory result	24,812	16,692	14,671	176	16,956	1,966	96	52
<b>Coal</b>								
<i>BHP Mitsubishi Alliance</i> <sup>10</sup>	7,652	3,197	2,572		7,545	488		
<i>New South Wales Energy Coal</i> <sup>11</sup>	3,455	1,953	1,868		(243)	156		
<i>Other</i>	–	(39)	(57)		(36)	13		
Total Coal from Group production	11,107	5,111	4,383	–	7,266	657		
<i>Third-party products</i>	–	–	–	–	–	–		
Total Coal	11,107	5,111	4,383	–	7,266	657	13	6
<i>Adjustment for equity accounted investments</i> <sup>11</sup>	(149)	(113)	(88)	–	–	–	–	–
Total Coal statutory result	10,958	4,998	4,295	–	7,266	657	13	6
<b>Group and unallocated items</b>								
<i>Potash</i>	–	(205)	(207)		4,469	647	1	1
<i>Western Australia Nickel</i> <sup>12</sup>	2,009	162	55		2,255	683	52	48
<i>Other</i> <sup>13</sup>	11	(344)	(804)		(1,295)	82	43	42
Total Group and unallocated items	2,020	(387)	(956)	(64)	5,429	1,412	96	91
Inter-segment adjustment	–	–	–	–	–	–	–	–
<b>Total Group</b>	<b>53,817</b>	<b>27,956</b>	<b>22,820</b>	<b>112</b>	<b>63,880</b>	<b>6,733</b>	<b>350</b>	<b>294</b>

1. Group profit before taxation comprised Underlying EBITDA of US\$29,016 million (FY2023: US\$27,956 million), exceptional items, depreciation, amortisation and impairments of US\$11,479 million (FY2023: US\$5,024 million) and net finance costs of US\$1,489 million (FY2023: US\$1,531 million).

2. Total revenue from thermal coal sales, including BMA and NSWEC, was US\$1,873 million (FY2023: US\$3,528 million).

3. For more information on the reconciliation of non-IFRS financial information to our statutory measures, reasons for usefulness and calculation methodology, please refer OFR 10 'Non-IFRS financial information'.

4. Excludes exceptional items relating to Net finance costs US\$506 million and Income tax benefit US\$837 million (FY2023: Net finance costs US\$452 million and Income tax expense US\$266 million).

5. Includes US\$10 million (FY2023: US\$ nil) of exploration expenditure previously capitalised, written off as impaired (included in depreciation and amortisation).

6. Includes Spence and Cerro Colorado. Cerro Colorado entered temporary care and maintenance in December 2023.

7. Antamina, SolGold and Resolution (the latter two included in Other) are equity accounted investments and their financial information presented above with the exception of net operating assets reflects BHP Group's share. Group and Copper level information is reported on a statutory basis which reflects the application of the equity accounting method in preparing the Group financial statements – in accordance with IFRS. Underlying EBITDA of the Group and the Copper segment, includes D&A, net finance costs and taxation expense of US\$525 million (FY2023: US\$545 million) related to equity accounted investments.

8. Includes Olympic Dam as well as Prominent Hill and Carrapateena which were acquired on 2 May 2023 as part of the acquisition of OZL.
9. Samarco is an equity accounted investment. With the exception of net operating assets, the financial information presented reflects BHP Billiton Brasil Ltda's share. All financial impacts following the Samarco dam failure have been reported as exceptional items in both reporting periods.
10. On 2 April 2024 BHP and Mitsubishi Development Pty Ltd (MDP) completed the divestment of the Blackwater and Daunia mines (which were part of the BHP Mitsubishi Alliance (BMA) to Whitehaven Coal. This resulted in a net after tax gain of US\$674 million that has been recognised as an exceptional item. BHP continued to report its share of profit and loss within the Coal Segment and asset tables until that date. Refer to Financial Statements Note 3 'Exceptional items' for further information.
11. Includes Newcastle Coal Infrastructure Group (NCIG) which is an equity accounted investment and its financial information presented above, with the exception of net operating assets, reflects BHP Group's share. Total Coal statutory result excludes contribution related to NCIG until future profits exceed accumulated losses.
12. Western Australia Nickel comprises the Nickel West operations and, following the OZL acquisition on 2 May 2023, the West Musgrave project.
13. Other includes functions, other unallocated operations including legacy assets and consolidation adjustments. Revenue not attributable to reportable segments comprises the sale of freight and fuel to third parties, as well as revenues from unallocated operations. Exploration and technology activities are recognised within relevant segments.

## 4 Production

The table below details our mineral and derivative product production for all operations for the three years ended 30 June 2024, 2023 and 2022. Unless otherwise stated, the production numbers represent our share of production and include BHP's share of production from which profit is derived from our equity accounted investments. Production information for equity accounted investments is included to provide insight into the operational performance of these entities.

For information on minerals pricing during the past three years refer to OFR 9

	BHP interest %	BHP share of production <sup>1</sup> Year ended 30 June		
		2024	2023	2022
<b>Copper<sup>2</sup></b>				
<b>Payable metal in concentrate (kt)</b>				
Escondida, Chile <sup>3</sup>	57.5	926.7	832.7	802.6
Pampa Norte, Chile <sup>4</sup>	100	150.3	125.3	111.2
Copper South Australia, Australia <sup>5</sup>	100	106.3	19.9	
Antamina, Peru <sup>6</sup>	33.75	143.9	138.4	149.9
Carajás, Brazil <sup>7</sup>	100	8.4	1.6	
Total		1,335.6	1,117.9	1,063.7
<b>Cathode (kt)</b>				
Escondida, Chile <sup>3</sup>	57.5	198.6	222.6	201.4
Pampa Norte, Chile <sup>4</sup>	100	115.3	163.5	170.0
Copper South Australia, Australia <sup>5</sup>	100	215.7	212.5	138.4
Total		529.6	598.6	509.8
<b>Total copper (kt)</b>				
		1,865.2	1,716.5	1,573.5
<b>Lead</b>				
<b>Payable metal in concentrate (t)</b>				
Antamina, Peru <sup>6</sup>	33.75	332	657	1,118
Total		332	657	1,118

	BHP interest %	BHP share of production <sup>1</sup> Year ended 30 June		
		2024	2023	2022
<b>Zinc</b>				
<b>Payable metal in concentrate (t)</b>				
Antamina, Peru <sup>6</sup>	33.75	<u>103,392</u>	125,048	123,200
Total		<u>103,392</u>	125,048	123,200
<b>Gold</b>				
<b>Payable metal in concentrate (troy oz)</b>				
Escondida, Chile <sup>3</sup>	57.5	<u>181,061</u>	189,095	166,972
Pampa Norte, Chile <sup>4</sup>	100	<u>13,280</u>	26,811	28,870
Copper South Australia, Australia <sup>5</sup>	100	<u>163,061</u>	32,736	
Carajás, Brazil <sup>7</sup>	100	<u>5,813</u>	1,153	
Total		<u>363,215</u>	249,795	195,842
<b>Refined gold (troy oz)</b>				
Copper South Australia, Australia <sup>5</sup>	100	<u>207,123</u>	186,029	119,517
Total		<u>207,123</u>	186,029	119,517
<b>Total gold (troy oz)</b>				
		<u>570,338</u>	435,824	315,359
<b>Silver</b>				
<b>Payable metal in concentrate (troy koz)</b>				
Escondida, Chile <sup>3</sup>	57.5	<u>5,446</u>	5,074	5,334
Pampa Norte, Chile <sup>4</sup>	100	<u>1,654</u>	1,318	1,011
Copper South Australia, Australia <sup>5</sup>	100	<u>1,134</u>	201	
Antamina, Peru <sup>6</sup>	33.75	<u>3,359</u>	3,885	5,078
Total		<u>11,593</u>	10,478	11,423
<b>Refined silver (troy koz)</b>				
Copper South Australia, Australia <sup>5</sup>	100	<u>995</u>	1,089	743
Total		<u>995</u>	1,089	743
<b>Total silver (troy koz)</b>				
		<u>12,588</u>	11,567	12,166
<b>Uranium</b>				
<b>Payable metal in concentrate (t)</b>				
Copper South Australia, Australia <sup>5</sup>	100	<u>3,603</u>	3,406	2,375
Total		<u>3,603</u>	3,406	2,375
<b>Molybdenum</b>				
<b>Payable metal in concentrate (t)</b>				
Pampa Norte, Chile <sup>4</sup>	100	<u>794</u>	990	71
Antamina, Peru <sup>6</sup>	33.75	<u>1,822</u>	1,172	798
Total		<u>2,616</u>	2,162	869
<b>Iron Ore</b>				
<b>Production (kt)<sup>8</sup></b>				
Newman Joint Venture, Australia	85	<u>58,102</u>	56,945	57,041
Area C Joint Venture, Australia	85	<u>105,868</u>	107,375	94,431
Yandi Joint Venture, Australia	85	<u>17,855</u>	21,410	38,922
Jimblebar, Australia <sup>9</sup>	85	<u>73,111</u>	66,801	58,782
<b>Total Western Australia Iron Ore</b>		<u>254,936</u>	252,531	249,176
Samarco, Brazil <sup>6</sup>	50	<u>4,748</u>	4,512	4,071
<b>Total iron ore</b>		<u>259,684</u>	257,043	253,247

	BHP interest %	BHP share of production <sup>1</sup> Year ended 30 June		
		2024	2023	2022
<b>Steelmaking coal</b>				
<b>Production (kt)<sup>10</sup></b>				
Blackwater, Australia <sup>11</sup>	50	3,572	5,055	5,834
Goonyella Riverside, Australia	50	6,434	8,310	8,360
Peak Downs, Australia	50	4,217	5,480	4,944
Saraji, Australia	50	3,287	4,596	4,614
Daunia, Australia <sup>11</sup>	50	1,513	1,989	1,491
Caval Ridge, Australia	50	3,252	3,590	3,899
<b>Total BHP Mitsubishi Alliance (BMA)</b>		<b>22,275</b>	<b>29,020</b>	<b>29,142</b>
South Walker Creek, Australia <sup>12</sup>	80	—	—	4,941
Poitrel, Australia <sup>12</sup>	80	—	—	2,981
<b>Total BHP Mitsui Coal<sup>12</sup></b>		<b>—</b>	<b>—</b>	<b>7,922</b>
<b>Total steelmaking coal</b>		<b>22,275</b>	<b>29,020</b>	<b>37,064</b>
<b>Energy coal</b>				
<b>Production (kt)</b>				
New South Wales Energy Coal, Australia	100	15,368	14,172	13,701
Cerrejón, Colombia <sup>6,13</sup>	33.3	—	—	4,236
<b>Total energy coal</b>		<b>15,368</b>	<b>14,172</b>	<b>17,937</b>
<b>Nickel</b>				
<b>Saleable production (kt)</b>				
Western Australia Nickel, Australia <sup>14, 15</sup>	100	81.6	80.0	76.8
Total		<b>81.6</b>	<b>80.0</b>	<b>76.8</b>
<b>Cobalt</b>				
<b>Saleable production (t)</b>				
Western Australia Nickel, Australia <sup>14, 15</sup>	100	734	752	632
Total		<b>734</b>	<b>752</b>	<b>632</b>

For persons

1. BHP share of production includes the Group's share of production for which profit is derived from our equity accounted investments, unless otherwise stated.
2. Metal production is reported on the basis of payable metal.
3. Shown on 100 per cent basis. BHP interest in saleable production is 57.5 per cent.
4. Includes Spence for the full year and Cerro Colorado which entered temporary care and maintenance in December 2023.
5. The year ended 30 June 2024 includes Olympic Dam, Prominent Hill and Carrapateena. The year ended 30 June 2023 includes Olympic Dam and two months of production from Prominent Hill and Carrapateena from 1 May 2023, following the acquisition of OZ Minerals on 2 May 2023.
6. For statutory financial reporting purposes, this is an equity accounted investment. We have included production numbers from our equity accounted investments as the level of production and operating performance from these operations impacts Underlying EBITDA of the Group. Our use of Underlying EBITDA is explained in OFR 4.3.
7. The year ended 30 June 2023 includes two months of production from 1 May 2023, following the acquisition of OZ Minerals on 2 May 2023.
8. Iron ore production is reported on a wet tonnes basis.
9. Shown on 100 per cent basis. BHP interest in saleable production is 85 per cent.
10. Steelmaking coal production is reported on the basis of saleable product. Production figures may include some thermal coal.
11. BHP completed the sale of the Blackwater and Daunia mines on 2 April 2024. Production reported until their divestment on 2 April 2024.
12. Shown on 100 per cent basis. BHP completed the sale of its 80 per cent interest in BHP Mitsui Coal (BMC) on 3 May 2022. Production reported until 30 April 2022.
13. BHP completed the sale of our 33.3 per cent interest in Cerrejón on 11 January 2022. Production for Cerrejón reported until 31 December 2021.
14. Nickel contained in matte and refined nickel metal, including briquette, powder, nickel sulphate and by-product streams.
15. On 11 July 2024, we announced the temporary suspension of operations at Western Australia Nickel from October 2024, with a transition period to commence from July 2024.

## 5 Major projects

Jansen Stage 1 (JS1) is 52 per cent complete and remains on track for first production in late CY2026 with a two-year ramp-up period. The engineering work and execution of procurement agreements is largely complete. In FY2025, underground and surface construction works will continue, including structural, mechanical and electrical activities for the mill areas. We also expect to complete the conversion of the service shaft headframe to a permanent structure. In FY2025, we estimate capex of US\$1.3 billion for JS1 (FY2024: US\$0.9 billion).

In October 2023, we approved an investment of US\$4.9 billion for Jansen Stage 2 (JS2), which when combined with JS1, will increase our total planned potash production capacity to approximately 8.5 Mtpa representing around 10 per cent of the estimated market when fully ramped up. JS2 execution activity has now commenced and is 2 per cent complete, with first production expected in FY2029, followed by a three-year ramp-up period. In FY2025, the focus will be on detailed engineering, procurement for major equipment and construction packages, and structural steel fabrication. In FY2025, we estimate capex of US\$0.5 billion for JS2 (FY2024: US\$0.2 billion).

Commodity	Project and ownership	Project scope/capacity	Capital expenditure US\$M	First production target date	Progress
Potash	Jansen Stage 1 (Canada) 100%	Design, engineering and construction of an underground potash mine and surface infrastructure, with capacity to produce 4.15 Mtpa	5,723	End-CY2026	Project is 52% complete
Potash	Jansen Stage 2 (Canada) 100%	Development of additional mining districts, completion of the second shaft hoist infrastructure, expansion of processing facilities and addition of rail cars to facilitate production of an incremental 4.36 Mtpa	4,859	FY2029	Project is 2% complete

Capital and exploration expenditure was US\$9.3 billion in FY2024. This was made up of investment in organic development of US\$5.9 billion, which includes approximately US\$2.7 billion on copper projects and approximately US\$1.1 billion at Jansen, plus an exploration spend of US\$0.5 billion primarily at Copper South Australia; and maintenance<sup>1</sup> and decarbonisation expenditure of US\$3.0 billion with US\$1.2 billion sustaining capital at WAIO to support our medium-term goal of producing >305 Mtpa. In July this year, we signed an agreement with Lundin Mining to jointly acquire Filo Corp. and to enter a joint venture with the intent of developing the Filo del Sol and Josemaria copper projects.

Capital and exploration expenditure of approximately US\$10 billion is expected for FY2025, including approximately US\$0.5 billion of exploration. In FY2026 and the medium term,<sup>2</sup> capital and exploration expenditure of approximately US\$11 billion per annum on average is expected. We have flexibility to adjust capital spend and phasing of projects to accommodate market dynamics and cash flow generation. Guidance is subject to exchange rate movements.

1. Maintenance capital includes non-discretionary spend for the following purposes: deferred development and production stripping; risk reduction, compliance and asset integrity.
2. Average for FY2027–FY2029.

## 6 Mineral resources and mineral reserves

Our mineral resources and mineral reserves presented in this annual report have been prepared in accordance with US Securities and Exchange Commission (SEC) regulations Subpart 1300 of Regulation S-K (S-K 1300).

Mineral resource is a concentration or occurrence of material of economic interest in or on the Earth's crust in such form, grade or quality, and quantity that there are reasonable prospects for economic extraction. A mineral resource is a reasonable estimate of mineralisation, taking into account relevant factors such as cut-off grade, likely mining dimensions, location or continuity, that, with the assumed and justifiable technical and economic conditions, is likely to, in whole or in part, become economically extractable. It is not merely an inventory of all mineralisation drilled or sampled.

Our mineral resources have been classified as measured, indicated or inferred depending on the level of geological certainty and confidence in the estimates, as defined in Item 1300 of S-K 1300.

Mineral reserve is an estimate of tonnage and grade or quality of indicated and measured mineral resources that, in the opinion of the qualified person, can be the basis of an economically viable project. More specifically, it is the economically mineable part of a measured or indicated mineral resource, which includes diluting materials and allowances for losses that may occur when the material is mined or extracted.

Our mineral reserves have been classified as proven and probable depending on the mineral resource classification and level of confidence in the assumptions, as defined in Item 1300 of S-K 1300.

To estimate mineral reserves, assumptions are required about a range of technical and economic factors, including quantities, qualities, production and processing techniques, recovery efficiency, production and transport costs, commodity supply and demand, commodity prices and exchange rates. Estimating the quantity and/or quality of mineral reserves requires the size, shape and depth of ore bodies to be determined by analysing geological data such as drilling samples and geophysical survey interpretations. Economic assumptions used to estimate reserves may change from period to period as additional technical, financial and operational data becomes available.

Our mineral resources and mineral reserves are constrained to tenure that we have rights to. Our mineral leases are of sufficient duration (or convey a legal right to renew for sufficient duration) to enable all reserves on the leased properties to be mined in accordance with current production schedules. Reserves may include areas where some additional approvals remain outstanding, however it is anticipated these approvals will be obtained within the timeframe required by the current life of mine schedules.

### Presentation of mineral resources and mineral reserves

Mineral resources and mineral reserves are presented at the proportion attributable to our economic interest and represent estimates as at 30 June 2024. Mineral resources are presented exclusive of mineral reserves. The specific point of reference and commodity prices defining the mineral resources and mineral reserves estimates are provided in the footnotes associated with each of the mineral resources and mineral reserves tables. Quantities of mineral reserves and mineral resources are reported in million metric tonnes (Mt). Tonnes are reported as dry metric tonnes (unless otherwise stated). All tonnes and quality information have been rounded, small differences may be present in the totals. Refer to the glossary for definitions of technical terms relating to mineral resources, mineral reserves, geology, mining or related matters and abbreviations.

Our mineral resources and mineral reserves presented in this annual report differ from the Mineral Resources and Ore Reserves we report in our home jurisdiction of Australia. The jurisdiction of Australia requires reporting in accordance with the Australian Stock Exchange (ASX) listing rules and the Australasian Code for reporting of Exploration Results, Mineral Resources and Ore Reserves, December 2012 (the JORC Code).

A key difference in the estimation of our resources and reserves pursuant to the ASX listing rules and S-K 1300 are the economic inputs, commodity prices and cost assumptions. Estimates we report in accordance with the ASX listing rules are generally based on cost forecasts and internally-generated, projected long-term commodity prices and current operating costs or costs used in studies for development projects.

S-K 1300 requires mineral resources and mineral reserves estimates to be based on reasonable and justifiable commodity prices selected by a qualified person. Further, the prices must provide a reasonable basis for establishing the prospects of economic extraction for mineral resources. Commodity price estimates included in this report are based on historical average commodity prices, which may differ from the price estimates used in the estimation of our resources and reserves pursuant to the ASX listing rules. Our mineral resources are based on the third-quartile average monthly prices over the timeframe of 1 July 2020 to 30 June 2023, unless otherwise stated. Our mineral reserves are based on the second-quartile average monthly prices over the timeframe of 1 July 2020 to 30 June 2023, unless otherwise stated. Exceptions are described in the footnotes associated with each of the mineral resources or mineral reserves tables below.

Unless otherwise stated, the estimates included in this report are based on average costs over the timeframe of 1 July 2020 to 30 June 2023 for production-stage properties or, for development-stage properties, costs are determined from first principles.

For non-operated properties that we have an economic interest in, the commodity prices and costs used are as the operator has advised.

The qualified persons consider that the use of historic prices and costs are appropriate to demonstrate economic viability of the mineral resources and mineral reserves. The prices are factual and the time interval is of sufficient duration to consider a range of price fluctuations. The commodity prices used to estimate the mineral resources and mineral reserves are included as footnotes to the mineral resources and mineral reserves tables below.

### Internal controls and assurance programs

We have internal controls over our mineral resources and mineral reserves estimation efforts that are designed to produce reasonable and reliable estimates aligned with industry practice and our regulatory reporting requirements. The governance for our estimation efforts is located at both the asset and the BHP Group level within our Resource Centre of Excellence, an internal assurance team independent of our qualified persons and BHP employees who are responsible for the estimations. The assets provide first line assurance on estimates through peer review and validation processes. The Resource Centre of Excellence is responsible for assurance over the processes implemented by the assets as they relate to mineral resources and mineral reserves estimations and the compiling of the mineral resources and mineral reserves estimates to be reported in accordance with S-K 1300.

Our internal controls utilise management systems, including, but not limited to, formal quality assurance and quality control processes, standardised procedures, workflow processes, data security covering record keeping, chain of custody and data storage, supervision and management approval, reconciliations, internal and external reviews and audits.

Our internal requirements and standards provide the basis for the governance over the estimation and reporting of mineral resources and mineral reserves and provide technical guidance to all reporting assets. These internal requirements and standards are periodically reviewed and updated for alignment with industry practice and reporting regulations.

Our internal controls for exploration data, as they relate to mineral resources and mineral reserves estimations are managed by our operating assets with assurance provided by the Resource Centre of Excellence. These controls include, but are not limited to:

- Documented procedures and standards defining minimum requirements on critical aspects to support exploration and resource development programs.
- Peer review of data collection including staged sign off by reviewers.
- Quality control checks on drill hole positions, collar and down hole surveys.
- Geological logs verified by either peer review or cross validation from other data sources, such as, sample analysis, downhole geophysical logging, core photography or scanning technologies.
- Sample security protocols at all stages of handling, from sample collection, transportation, preparation and analysis, including the storage of core or pulps post analysis.
- Industry standard practices for sample analysis quality control. Insertion of standards, duplicates, and blanks into sample batches at a frequency to enable the assessment of analytical data quality.
- Commercial or internal laboratories site inspected periodically and their internal quality control data is reviewed. From time to time a selection of samples are analysed at alternate laboratories to monitor laboratory performance.
- Quality control data reviewed at regular intervals to verify deviations to enable timely remediation.
- Quality assurance and quality control data validation and verification processes in place to support database integrity. This is based on automatic routines inbuilt into the geological databases. Inconsistencies are reviewed, verified and where required rectified by the responsible geologist.
- Geological databases periodically audited from source data.
- Geological data is stored on servers in accordance with BHP security standards, which include controls relating to access and backup routines.
- Geological models, including interpretation and mineralisation domains, internally peer reviewed prior to estimation.

Our internal controls for mineral resources and mineral reserves estimations include, but are not limited to:

- Source data review from database extracts, using exploratory data statistical analysis prior to use in the estimation of mineral resources. Identification of data to exclude, outliers and visual checks against estimation domains.
- Peer reviews of the estimation inputs based on statistical studies and estimation parameters as applied in industry standard estimation software.



- Visual and statistical validation of the estimates against source data and where available reconciliation to previous models, operational models and production data.
- Peer review of the classification applied, considering quantitative measures and qualitative considerations.
- Peer review of assumptions applied that convert resources to reserves.
- Independent audits or reviews for new or materially changed mineral resources and mineral reserves.

Operating assets manage internal risk registers relating to uncertainties in the mineral resources and mineral reserves estimates to direct future work programs or estimation updates. These may include but are not limited to:

- Areas of uncertainty in the estimates impacting local interpretations.
- Bulk density assumptions, based on sample test work or operational results.
- Metallurgical recovery assumptions, based on test work or plant performance.
- Changes in commodity prices, costs and exchange rate assumptions.
- Geotechnical and hydrogeological considerations impacting on underground or open cut mining assumptions.
- Ore loss and dilution, mining selectivity and production rate assumptions.
- Cut-off value changes to meet product specifications.
- Changes in environmental, permitting and social license to operate assumptions.

Further to assurance activities by the assets specifically relating to the estimation of mineral resources and mineral reserves, the Resource Centre of Excellence with subject matter experts have developed standards and guidelines across BHP for reviewing and documenting the information supporting our mineral resources and mineral reserves estimates, describing the methods used and verifying the reliability of such estimates. These activities are supported by the following controls:

- The reporting of mineral resources and mineral reserves estimates are required to follow BHP's standard procedures for public reporting in accordance with current regulatory requirements.
- Annual risk reviews are conducted with qualified persons and BHP employees on all mineral resources and mineral reserves to be reported. Including year on year change impact assessment, reconciliation performance metrics for the operating mines and control assessment for the estimation inputs. The information and supporting documentation is prepared by the applicable qualified persons relating to the estimates and is evaluated for compliance with BHP's internal controls. Based on these reviews, recommendations of endorsement are provided to our senior management for the use and reporting of the mineral resources and mineral reserves estimates.
- Periodic internal technical 'deep dive' assessments of mineral resources and mineral reserves estimates are conducted on a frequency that is informed by asset materiality and outcomes of the annual risk reviews.
- Management and closure reviews of actions assigned to qualified persons and BHP employees resulting from the annual risk reviews and technical 'deep dive' assessments are conducted.
- Assurance is undertaken over the reporting documentation provided by qualified persons for public release and management and verification of inputs into BHP mineral resources and mineral reserves reporting database.

The Resource Centre of Excellence also provides an annual update on assurance activities and changes relating to our mineral resources and mineral reserves estimation efforts to the Risk and Audit Committee (RAC) in connection with the RAC's responsibility over the effectiveness of systems of internal control and risk management of BHP.

#### **Inherent risks in the estimation of mineral resources and mineral reserves**

The estimation of our mineral resources and mineral reserves are largely based on historical average prices of the commodities we produce or intend to produce, primarily iron ore, copper, coal and potash. Estimated annual cash flows from our future operations, estimated production schedules, estimated capital expenditure and operating costs, estimated site closure costs, estimated royalty and tax costs, valuation assumptions and interpretations of geologic data obtained from drill holes and other exploration techniques, all of which may not necessarily be indicative of future results. The assumptions and interpretations used to estimate our mineral resources and mineral reserves may change from period to period, and, because additional geological data generated during the course of our operations may not be consistent with the data on which we based our mineral resources and mineral reserves, such estimates may change from period to period or may need to be revised. No assurance can be given that our mineral resources or mineral reserves presented in this report will be recovered at the grade, quality or quantities presented or at all.

There are numerous uncertainties inherent in the estimation of mineral resources and mineral reserves. Areas of uncertainty that may materially impact our mineral resources or mineral reserves estimates may include, but are not limited to: (i) changes to long-term commodity prices, external market factors, foreign exchange rates and other economic assumptions; (ii) changes in geological interpretations of mineral deposits and geological modelling, including estimation input parameters and techniques; (iii) changes to metallurgical or process recovery assumptions which adversely affect the volume, grade or qualities of our commodities produced (for example, processing that results in higher deleterious elements that result in penalties) or other changes to mining method assumptions; (iv) changes to input assumptions used to derive the potentially mineable shapes applicable to the assumed underground or open pit mining methods used to constrain the estimates; (v) changes to life of mine or production rate assumptions; (vi) changes to dilution and mining recovery assumptions; (vii) changes to cut-off grades applied to the estimates; (viii) changes to geotechnical data, structures, rock mass strength, stress regime, hydrogeological, hydrothermal or geothermal factors; (ix) changes to infrastructure supporting the operations of or access to the applicable mine site; (x) changes to mineral, surface, water or other natural resources rights; (xi) changes to royalty, taxes, environmental, permitting and social license assumptions in the jurisdictions in which we operate; and (xii) changes in capital or operating costs.

Additionally, the term “mineral resources” does not indicate recoverable proven and probable mineral reserves pursuant to S-K 1300. Estimates of mineral resources are subject to further exploration and evaluation of development and operating costs, grades, recoveries and other material factors, and, therefore, are subject to considerable uncertainty. Mineral resources do not meet the threshold for mineral reserve modifying factors, such as engineering, legal or economic feasibility, that would allow for the conversion to mineral reserves. Accordingly, no assurance can be given that our mineral resources not included in mineral reserves will become recoverable proven and probable mineral reserves.

Refer to “Forward-looking statements” and the risk factors set out in OFR 8.1 for other factors that may affect our mineral resources and mineral reserves estimates.

For personal use only

## 6.1 Copper

### Mineral resources

As at 30 June 2024

Copper <sup>1,2</sup>	Mining method	Measured Mineral Resources					Indicated Mineral Resources					Measured + Indicated Mineral Resources					Inferred Mineral Resources										
		Tonnage		Qualities			Tonnage		Qualities			Tonnage		Qualities			Tonnage		Qualities								
		Mt	%Cu	g/tAu			Mt	%Cu	g/tAu			Mt	%Cu	g/tAu			Mt	%Cu	g/tAu			Mt	%Cu	g/tAu			
<b>Chile</b>																											
<b>Escondida<sup>3,4,5,6,7</sup></b>																											
	OC	15	0.38	–	–	–	6.0	0.53	–	–	–	21	0.42	–	–	–	1.0	0.51	–	–	–	–	–	–	–		
	Mixed	–	–	–	–	–	16	0.48	–	–	–	16	0.48	–	–	–	12	0.45	–	–	–	–	–	–	–		
	Sulphide	296	0.43	–	–	–	1,420	0.54	–	–	–	1,720	0.52	–	–	–	5,510	0.53	–	–	–	–	–	–	–		
	<b>Escondida Total</b>	<b>311</b>	<b>0.43</b>	–	–	–	<b>1,450</b>	<b>0.54</b>	–	–	–	<b>1,760</b>	<b>0.52</b>	–	–	–	<b>5,520</b>	<b>0.53</b>	–	–	–	–	–	–	–		
<b>Brazil</b>																											
	Pedra Branca <sup>9</sup>	UG	0.26	1.48	0.46	–	3.1	1.58	0.41	–	–	3.4	1.58	0.42	–	–	5.1	1.48	0.37	–	–	–	–	–	–		
<b>Australia</b>																											
	Olympic Dam <sup>10</sup>	UG	Mt	%Cu	kg/tU <sub>3</sub> O <sub>8</sub>	g/tAu	g/tAg	Mt	%Cu	kg/tU <sub>3</sub> O <sub>8</sub>	g/tAu	g/tAg	Mt	%Cu	kg/tU <sub>3</sub> O <sub>8</sub>	g/tAu	g/tAg	Mt	%Cu	kg/tU <sub>3</sub> O <sub>8</sub>	g/tAu	g/tAg	Mt	%Cu	kg/tU <sub>3</sub> O <sub>8</sub>	g/tAu	g/tAg
			527	1.32	0.36	0.54	2	372	1.30	0.36	0.47	3	899	1.31	0.36	0.51	2	190	1.44	0.41	0.63	3	–	–	–	–	–
	Prominent Hill & Carrapateena <sup>11</sup>	UG	Mt	%Cu	g/tAu	g/tAg	Mt	%Cu	g/tAu	g/tAg	Mt	%Cu	g/tAu	g/tAg	Mt	%Cu	g/tAu	g/tAg	Mt	%Cu	g/tAu	g/tAg	Mt	%Cu	g/tAu	g/tAg	
			80	0.86	0.39	3	–	430	0.50	0.25	2	–	510	0.56	0.28	2	–	360	0.37	0.26	2	–	–	–	–	–	
<b>Peru</b>																											
	Antamina <sup>12</sup>	OC & UG	Mt	%Cu	%Zn	g/tAg	ppmMo	Mt	%Cu	%Zn	g/tAg	ppmMo	Mt	%Cu	%Zn	g/tAg	ppmMo	Mt	%Cu	%Zn	g/tAg	ppmMo	Mt	%Cu	%Zn	g/tAg	ppmMo
			77	0.76	0.38	10	180	150	0.87	0.70	12	190	227	0.83	0.59	11	190	400	1.03	0.57	11	170	–	–	–	–	
	<b>Total copper</b>		<b>1,400</b>	<b>0.81</b>	–	–	–	<b>3,040</b>	<b>0.62</b>	–	–	–	<b>4,440</b>	<b>0.68</b>	–	–	–	<b>7,310</b>	<b>0.56</b>	–	–	–	–	–	–	–	

<sup>1</sup> Mineral resources are reported in this report in accordance with S-K 1300 and are presented for the portion attributable to BHP's economic interest. All tonnes and quality information have been rounded, small differences may be present in the totals.

<sup>2</sup> Mineral resources are presented exclusive of mineral reserves.

<sup>3</sup> Escondida, in which BHP has a 57.5% interest, is considered a material property for purposes of Item 1304 of S-K 1300.

<sup>4</sup> Escondida point of reference for the mineral resources was mine gate.

<sup>5</sup> Escondida mineral resources estimates were based on a copper price of US\$4.29/lb.

<sup>6</sup> Escondida mineral resources cut-off criteria used was Oxide  $\geq 0.20\%$  soluble Cu; Mixed  $\geq 0.30\%$  Cu; Sulphide  $\geq 0.25\%$  Cu for mineralisation assigned to be processed via leaching or  $\geq 0.30\%$  Cu for mineralisation assigned to be processed via the concentrator.

<sup>7</sup> Escondida metallurgical recoveries were Oxide 62%; Mixed 42%; Sulphide 42% for material processed by sulphide leach, Sulphide 77% for material processed by Full Sal and Sulphider 85% for material processed via the concentrator.

<sup>8</sup> Pampa Norte, in which BHP has a 100% interest, includes Cerro Colorado and Spence deposits. The mineral resources estimates were based on a copper price of US\$4.29/lb. The point of reference for the mineral resources was mine gate.

<sup>9</sup> Pedra Branca mineral resources, in which BHP has a 100% interest, were based on historic asset determined prices with a copper price of US\$4.13/lb and gold price of US\$1,650/oz. The point of reference for the mineral resources was in situ.

<sup>10</sup> Olympic Dam mineral resources estimates, in which BHP has a 100% interest, were based on a copper price of US\$4.29/lb, uranium oxide price of US\$49.74/lb, gold price of US\$1,899/troy oz and silver price of US\$25.33/troy oz. The point of reference for the mineral resources was mine gate, ex-processing.

<sup>11</sup> Prominent Hill & Carrapateena mineral resources estimates, in which BHP has a 100% interest, were based on historic asset determined prices with a copper price of US\$3.40/lb, gold price of US\$1450/troy oz and silver price of US\$19/troy oz. The point of reference for the mineral resources was in situ.

<sup>12</sup> Antamina mineral resources estimates, in which BHP has a 33.75% interest, were based on a copper price of US\$3.50/lb, zinc price of US\$1.30/lb, silver price of US\$24.60/troy oz and molybdenum price of US\$13.30/lb. The point of reference for the mineral resources was in situ.

Mineral reserves

As at 30 June 2024

Copper <sup>1</sup>	Mining method	Proven Mineral Reserves					Probable Mineral Reserves					Total Mineral Reserves				
		Tonnage	Qualities				Tonnage	Qualities				Tonnage	Qualities			
Chile		Mt	%Cu				Mt	%Cu				Mt	%Cu			
<b>Escondida<sup>2,3,4,5,6</sup></b>																
Full SaL	OC	113	0.77	–	–	–	13	0.68	–	–	–	126	0.76	–	–	–
Sulphide	OC	1,860	0.64	–	–	–	690	0.54	–	–	–	2,550	0.61	–	–	–
Sulphide Leach	OC	701	0.39	–	–	–	152	0.40	–	–	–	853	0.39	–	–	–
<b>Escondida Total</b>		<b>2,670</b>	<b>0.58</b>	–	–	–	<b>855</b>	<b>0.52</b>	–	–	–	<b>3,530</b>	<b>0.57</b>	–	–	–
Pampa Norte <sup>7</sup>	OC	607	0.54	–	–	–	383	0.51	–	–	–	990	0.53	–	–	–
<b>Brazil</b>																
		Mt	%Cu	g/tAu			Mt	%Cu	g/tAu			Mt	%Cu	g/tAu		
Pedra Branca <sup>8</sup>	UG	0.31	1.65	0.49	–	–	2.6	2.07	0.53	–	–	2.9	2.03	0.52	–	–
<b>Australia</b>																
		Mt	%Cu	kg/tU <sub>3</sub> O <sub>8</sub>	g/tAu	g/tAg	Mt	%Cu	kg/tU <sub>3</sub> O <sub>8</sub>	g/tAu	g/tAg	Mt	%Cu	kg/tU <sub>3</sub> O <sub>8</sub>	g/tAu	g/tAg
Olympic Dam <sup>9</sup>	UG	283	1.97	0.61	0.74	5	268	1.73	0.57	0.59	3	551	1.85	0.59	0.67	4
Prominent Hill & Carrapateena <sup>10</sup>	UG	23	1.18	0.54	3	–	162	1.21	0.53	4	–	185	1.21	0.52	4	–
<b>Peru</b>																
		Mt	%Cu	%Zn	g/tAg	ppmMo	Mt	%Cu	%Zn	g/tAg	ppmMo	Mt	%Cu	%Zn	g/tAg	ppmMo
Antamina <sup>11</sup>	OC	39	0.92	0.49	10	290	27	1.01	0.95	13	230	66	0.96	0.68	11	270
<b>Total copper</b>		<b>3,620</b>	<b>0.69</b>	–	–	–	<b>1,700</b>	<b>0.78</b>	–	–	–	<b>5,320</b>	<b>0.72</b>	–	–	–

<sup>1</sup> Mineral reserves are reported in this report in accordance with S-K 1300 and are presented for the portion attributable to BHP's economic interest. All tonnes and quality information have been rounded, small differences may be present in the totals.

<sup>2</sup> Escondida, in which BHP has a 57.5% interest, is considered a material property for purposes of Item 1304 of S-K 1300.

<sup>3</sup> Escondida point of reference for the mineral reserves was mine gate.

<sup>4</sup> Escondida mineral reserves estimates were based on a copper price of US\$4.03/lb.

<sup>5</sup> Escondida mineral reserves cut-off criteria used was Full SaL  $\geq 0.20\%$  soluble Cu. For Sulphide  $\geq 0.30\%$  Cu and where greater than the variable cut-off of the concentrator. Sulphide ore is processed in the concentrator plants as a result of an optimised mine plan with consideration of technical and economic parameters in order to maximise net present value. Sulphide Leach  $\geq 0.25\%$  Cu and 70% or less of copper contained in chalcopyrite and lower than the variable cut-off grade. Sulphide leach ore is processed in the leaching plant as an alternative to the concentrator process.

<sup>6</sup> Escondida metallurgical recoveries for Full SaL 76% (Oxide 62%, Mixed 42%, Sulphide 77%); Sulphide Leach 42%; Sulphide 85% for material processed via the concentrator.

<sup>7</sup> Pampa Norte, in which BHP has a 100% interest, includes Spence deposit. The mineral reserves estimates were based on a copper price of US\$4.03/lb. The point of reference for the mineral reserves was mine gate.

<sup>8</sup> Pedra Branca mineral reserves estimates, in which BHP has a 100% interest, were based on historic asset determined prices with a copper price of US\$7,960/t and gold price of US\$1,550/oz. The point of reference for the mineral reserves was mine gate.

<sup>9</sup> Olympic Dam mineral reserves estimates, in which BHP has a 100% interest, were based on a copper price of US\$4.03/lb, uranium oxide price of US\$44.46/lb, gold price of US\$1839/troy oz and silver price of US\$23.88/troy oz. The point of reference for the mineral reserves was mine gate, ex-processing.

<sup>10</sup> Prominent Hill & Carrapateena, in which BHP has a 100% interest, were based on historic asset determined prices with a copper price of US\$3.40/lb, gold price of US\$1450/troy oz and silver price of US\$19/troy oz. The point of reference for the mineral reserves was mine gate, ex-processing.

<sup>11</sup> Antamina mineral reserves estimates, in which BHP has a 33.75% interest, were based on a copper price of US\$3.50/lb, zinc price of US\$1.10/lb, silver price of US\$21.50/troy oz and molybdenum price of US\$11.10/lb. The point of reference for the mineral reserves was delivery to processing plant.

## 6.2 Escondida individual property disclosure

### 6.2.1 Property description

Escondida copper mine (Escondida) is a production stage property operated by Minera Escondida Limitada (MEL) consisting of Escondida and Escondida Norte deposits located in the Atacama Desert of northern Chile, approximately 170 km south-east of Antofagasta at an elevation of approximately 3,100 m above sea level.

The location of the operations centred upon the two pits are listed and shown below.

- Escondida: Latitude 24°16' S, Longitude 69° 04' W
- Escondida Norte: Latitude 24°13' S, Longitude 69° 03' W



### 6.2.2 Infrastructure

All required infrastructure supporting the current mine plan including roads, rail and port, power and water supply is in place. Access to the property is via a company maintained private road available for public use from Antofagasta. The city of Antofagasta is serviced by the regional airport.

The site infrastructure, centred on the two pits, includes three sulphide concentrator plants, two leaching process facilities, associated cathode production plant, tailings storage facility, along with support and service facilities.

The nearby Coloso port facility receives copper concentrate via a pipeline from the mine site and processes this to a dry concentrate ready for stockpiling and loading via a dedicated concentrate ship loading facility. Both concentrate pipeline and port facilities are owned and operated by MEL.

Additional third-party owned port infrastructure is located at Antofagasta, including rail, train unloading and ship loading facilities.

Escondida utilises an existing privately owned railway system to transport copper cathode product from site and consumables to site through the ports of Antofagasta and Mejillones. Escondida owns a minor rail spur connecting the mine site into the publicly owned railway.

The source of water for the mine, processing plants and supporting infrastructure is provided from two seawater desalination plants located at Punta Coloso, and pumping facilities to site via two pipelines. Water is recovered from the tailings dam for re-use in the concentrator plants.

From January FY22 the total energy consumption of Escondida comes from renewable sources. This energy is provided through the current contracts of Enel and Colbún with an annual available consumption of 5.8 TWh/year. From FY25 onwards, Escondida is expected to have an available energy consumption of 6.0 TWh/year, due to the extension of the Colbún contract, which delivers energy from 100% renewable sources, supporting our goals to reduce CO<sub>2</sub> emissions.

The workforce is a combination of employees and contractors supporting the operations. Operational personnel reside on site in MEL accommodation and are sourced from Antofagasta or from other parts of Chile.

### 6.2.3 Mineral tenure

MEL holds a total of 764 mining concessions covering an area of 406,018 ha. There are 18 principal mining concessions that provide MEL with the right to explore and mine indefinitely, subject to payment of annual license fees. All leases were obtained through the legally established process in which judicial requests are presented to the Chilean state.

Lease name	Registered tenement holder	Expiry date	Surface area (ha)	Annual rent and rate (UTM) <sup>1</sup>
Alexis 1/1424	Minera Escondida Ltda.	Permanent	7,059	705.9
Amelia 1/1049	Minera Escondida Ltda.	Permanent	5,235	523.5
Catita 1/376	Minera Escondida Ltda.	Permanent	1,732	173.2
Claudia 1/70	Minera Escondida Ltda.	Permanent	557	55.7
Colorado 501/977	Minera Escondida Ltda.	Permanent	2,385	238.5
Costa 1/1861	Minera Escondida Ltda.	Permanent	9,159	915.9
Donaldo 1/612	Minera Escondida Ltda.	Permanent	3,060	306.0
Ela 1/100	Minera Escondida Ltda.	Permanent	500	50.0
Gata 1 1/100	Minera Escondida Ltda.	Permanent	400	40.0
Gata 2 1/50	Minera Escondida Ltda.	Permanent	200	20.0
Guillermo 1/368	Minera Escondida Ltda.	Permanent	1,785	178.5
Hole 14	Minera Escondida Ltda.	Permanent	1	0.1
Naty 1/46	Minera Escondida Ltda.	Permanent	230	23.0
Paola 1/3000	Minera Escondida Ltda.	Permanent	15,000	1,500.0
Pista 1/22	Minera Escondida Ltda.	Permanent	22	2.2
Pistita 1/5	Minera Escondida Ltda.	Permanent	9	0.9
Ramón 1/640	Minera Escondida Ltda.	Permanent	3,200	320.0
Rola 1/1680	Minera Escondida Ltda.	Permanent	8,400	840.0
<b>Total</b>			<b>58,934</b>	<b>5,893.0</b>

<sup>1</sup> Unidad Tributaria Mensual (UTM) is a Chilean state tax unit valued in Chilean pesos (CLP) per hectare. The 2024 rate is 0.1 UTM. Annual payments are made at the end of the Chilean tax year (end of March) for concessions.

In addition to mining concessions, Chilean law also regulates, independently of mining concessions, the rights to the use of the land surface. MEL owns 155,000 ha of surface rights and these are also renewable on an annual basis. These rights are also obtained through legal process presented to the Chilean state and potentially to other third party owners, including the Chilean “Consejo de Defensa del Estado” as required, MEL’s main surface rights cover operational activities such as pits, dumps, leach pads, plant and other infrastructure.

Infrastructure	Surface rights identifier <sup>1</sup>			Register	Regional office	Surface area (ha)
	Folio	Number	Year			
Pits, waste dumps, leach pads, plants	619 V	964	1984	Hipotecas y Gravámenes	Bienes Raíces Antofagasta	22,084
Energy transmission lines, aqueducts, mineral pipelines, roads	1121 V	1117	2018	Hipotecas y Gravámenes	Bienes Raíces Antofagasta	26,988

<sup>1</sup> As defined by Chilean legal requirements

MEL also holds maritime concessions for the Coloso port facilities. These concessions are requested through submission of the proposed project to the Chilean Ministry of Defence and are awarded by legal decree.

#### 6.2.4 Registrant interest

BHP does not hold any royalty in the Escondida property in addition to its economic interest of 57.5%.

#### 6.2.5 Present condition of property

Escondida is a production-stage property actively operating two open cut mines, Escondida and Escondida Norte.

Continuous resource definition activities are ongoing to upgrade mineral resources understanding to support the mine plans and to develop mineral reserves. These activities include drilling and in-pit mapping. Geological understanding of the two deposits is supported by a total of approximately 2,732 km of drilling undertaken in a total of approximately 8,737 drill holes.

Surface mining is by drilling and blasting along with shovel/excavator loading and truck haulage from each of the two open pits. Extracted sulphide ore undergoes crushing prior to processing in one of three concentrators with concentrate piped to the Coloso port for drying. Lower grade sulphide ore is directly dumped onto leach pads and is processed by biological leaching. Oxide and transitional ores are processed using heap leaching. Leached products are converted to copper cathode then railed to Antofagasta port.

#### 6.2.6 Physical condition

Construction commenced on the Escondida property in 1988 with first production in 1990. A number of expansion phases followed from 1993 onwards which included the development of additional infrastructure to increase production. Key milestones subsequent to first production in 1990 relating to the development of the operations were:

- 1998 Acid heap leaching of oxides commenced
- 2002 Second concentrator (Phase 4) inaugurated
- 2005 Mining commenced at Escondida Norte
- 2006 Dump bio-leaching of sulphides commenced
- 2007 First desalination plant commenced pumping
- 2016 Third concentrator inaugurated
- 2017 Second desalination plant commenced pumping
- 2020 Operation converted to 100% use of desalination water

The operations undertake planned maintenance programs and implement scheduled replacement of mine fleet and infrastructure components that is intended to maintain the continued reliable operating of equipment, facilities and infrastructure to meet operational requirements.

#### 6.2.7 Book value

The total book value for the Escondida property and its associated plant and equipment was US\$11.8 billion as of 30 June 2024.

#### 6.2.8 History of previous operations

Utah International Inc. (Utah) and Getty Oil Co. (Getty) commenced geochemical exploration in the region in 1978 which led to the discovery of Escondida deposit in 1981. In 1984 through corporate acquisitions, BHP acquired the Escondida property. Ownership changed in 1985 to a joint venture between BHP (57.5%), Rio Tinto Zinc (30%), JECO Corporation (10%) and World Bank (2.5%). The joint venture undertook all the subsequent exploration and development work to bring Escondida into operation in 1990. Current ownership, since 2010, is BHP (57.5%), Rio Tinto (30%), JECO Corporation (10%) and JECO 2 Limited (2.5%). Minera Escondida Limitada operates Escondida.

### 6.2.9 Significant encumbrances

Minera Escondida holds the licenses to operate pursuant to the current mine plan. BHP is not aware of any material encumbrances that would impact the current mineral resources or mineral reserves.

### 6.2.10 Geology and mineralisation

The Escondida and Escondida Norte copper deposits lie in the Escondida-Sierra de Varas shear lens of the Domeyko Fault System. The deposits are supergene-enriched copper porphyries with primary sulphide mineralisation associated with multiple phase intrusions of monzonite to granodiorite composition into host volcanics.

Primary mineralisation has undergone secondary supergene leaching and enrichment with associated local formation of copper oxide mineralisation, predominately brochantite. Supergene enrichment generated laterally-continuous and sub-horizontal high-grade sulphide mineralisation zones across the deposit, predominately chalcocite and covellite. The primary hypogene mineralisation, present in the deepest parts of the deposits is chalcopyrite with bornite.

### 6.2.11 Mineral resources and mineral reserves

Tables of mineral resources and mineral reserves for Escondida reported by ore type are included in section 6.1 above.

### 6.2.12 Changes to mineral resources and mineral reserves

Total mineral resources as at 30 June 2024 were 7,280 Mt, compared to the previous year as at 30 June 2023 which were 7,540 Mt, a decrease of 3% (-260 Mt). The changes were mainly due to mine factors and inclusion of additional drilling results to the estimate.

Total mineral reserves as at 30 June 2024 were 3,530 Mt, compared to the previous year as at 30 June 2023 which were 3,540 Mt, a decrease of less than 1% (-10 Mt). The changes were mainly due to depletion and increases in operating costs, partially offset by increase in commodity price.

### 6.2.13 Material assumptions and criteria

Material assumptions in the estimation of mineral resources are:

- Resources estimated using Ordinary Kriging
- The sample data preparation including data capping
- The pit optimisation used to determine the resources that have reasonable prospects of economic extraction
- Commodity price

Material assumptions in the estimation of mineral reserves are:

- The classified resource model
- Variable cut-off grade strategy that maximises throughput for the concentrator, smelter and refinery
- Mining dilution and mining recovery
- Processing plant throughput and yields
- The exchange rate
- The geotechnical parameters
- Commodity prices, operating and capital costs

Details of the material assumptions are described in the Technical Report Summary (effective 30 June 2022) incorporated as an exhibit to this Annual Report by reference to the exhibit to the Annual Report on Form 20-F for the year ended 30 June 2023, sections 11 Mineral Resource Estimates, 12 Mineral Reserve Estimates, 13 Mining Methods, 14 Processing and Recovery Methods and 18 Capital and Operating Costs.



### 6.3 Iron ore

#### Mineral resources

As at 30 June 2024

Iron ore <sup>1,2</sup>	Mining method	Measured Mineral Resources						Indicated Mineral Resources						Measured + Indicated Mineral Resources						Inferred Mineral Resources					
		Tonnage Mt	%Fe	%P	Qualities %SiO <sub>2</sub>	%Al <sub>2</sub> O <sub>3</sub>	%LOI	Tonnage Mt	%Fe	%P	Qualities %SiO <sub>2</sub>	%Al <sub>2</sub> O <sub>3</sub>	%LOI	Tonnage Mt	%Fe	%P	Qualities %SiO <sub>2</sub>	%Al <sub>2</sub> O <sub>3</sub>	%LOI	Tonnage Mt	%Fe	%P	Qualities %SiO <sub>2</sub>	%Al <sub>2</sub> O <sub>3</sub>	%LOI
<b>Australia</b>																									
<b>WAIO<sup>3,4,5,6,7,8</sup></b>																									
Mt Newman	OC	240	61.3	0.10	3.0	2.2	6.3	1,120	60.2	0.13	4.5	2.7	6.0	1,360	60.4	0.12	4.2	2.6	6.1	1,820	59.6	0.12	4.8	2.6	6.5
Goldsworthy <sup>9</sup>	OC	90	57.7	0.11	7.0	3.1	6.8	460	59.5	0.07	5.4	2.9	5.9	550	59.2	0.07	5.6	2.9	6.0	3,870	60.0	0.10	5.0	2.3	6.3
Yandi	OC	360	58.4	0.11	4.7	2.3	8.8	1,270	59.4	0.14	4.5	2.3	7.5	1,630	59.2	0.14	4.5	2.3	7.8	1,850	58.0	0.13	5.4	2.6	8.2
Jimblebar	OC	70	57.7	0.20	6.4	3.6	6.0	130	57.0	0.14	6.6	4.2	6.6	200	57.3	0.16	6.5	4.0	6.4	220	58.3	0.10	6.1	3.4	6.2
BHP (Non-JV) <sup>10</sup>	OC	220	60.0	0.13	5.1	2.6	5.9	110	58.0	0.11	6.8	2.9	6.7	340	59.3	0.12	5.6	2.7	6.2	2,020	58.9	0.13	4.8	2.8	7.1
<b>WAIO Total</b>		<b>980</b>	<b>59.4</b>	<b>0.12</b>	<b>4.7</b>	<b>2.5</b>	<b>7.2</b>	<b>3,090</b>	<b>59.6</b>	<b>0.12</b>	<b>4.8</b>	<b>2.6</b>	<b>6.7</b>	<b>4,070</b>	<b>59.5</b>	<b>0.12</b>	<b>4.8</b>	<b>2.6</b>	<b>6.8</b>	<b>9,780</b>	<b>59.3</b>	<b>0.12</b>	<b>5.0</b>	<b>2.6</b>	<b>6.9</b>

<b>Brazil</b>																									
Samarco <sup>11</sup>	OC	1,210	38.3	0.05	—	—	—	753	36.8	0.05	—	—	—	1,960	37.7	0.05	—	—	—	210	37.4	0.06	—	—	—
<b>Total Iron ore</b>		<b>2,190</b>	<b>47.7</b>	<b>—</b>	<b>—</b>	<b>—</b>	<b>—</b>	<b>3,840</b>	<b>55.1</b>	<b>—</b>	<b>—</b>	<b>—</b>	<b>—</b>	<b>6,030</b>	<b>52.4</b>	<b>—</b>	<b>—</b>	<b>—</b>	<b>—</b>	<b>9,990</b>	<b>58.8</b>	<b>—</b>	<b>—</b>	<b>—</b>	<b>—</b>

- 1 Mineral resources are reported in this report in accordance with S-K 1300 and are presented for the portion attributable to BHP's economic interest in the respective joint venture. All tonnes and quality information have been rounded, small differences may be present in the totals.
- 2 Mineral resources are presented exclusive of mineral reserves.
- 3 WAIO is considered a material property for purposes of Item 1304 of S-K 1300. BHP interest is 85% for all joint ventures except BHP (Non-JV) where it is 100%.
- 4 WAIO mineral resources qualities are presented as in situ mass percentage on a dry weight basis and tonnage as wet tonnes. Moisture content is based on deposit types, Brockman (BKM) – 3%; Marra Mamba (MM) – 4%; Channel Iron Deposit (CID) – 8% and Detrital Iron Deposits (DID) – 4%.
- 5 WAIO point of reference for the mineral resources was in situ.
- 6 WAIO mineral resources estimates were based on an iron ore price of US\$116/dmt for Platts 62% Fe Fines Index free on board (FOB) Port Hedland basis. Based on the median three-year monthly average price over a timeframe of 1 July 2020 to 30 June 2023.
- 7 WAIO mineral resource estimates cut-off criteria was based on deposit types identified in the joint venture. These are BKM and MM 54% Fe; CID 52% Fe and DID 58% Fe and less than 6% Al<sub>2</sub>O<sub>3</sub>.
- 8 WAIO is predominantly a producer of direct shipping ore and the metallurgical recovery was assumed as 100% for the purpose of reporting all mineral resources.
- 9 Goldsworthy joint venture includes 0.1 Mt indicated mineral resources from the POSMAC joint venture in which BHP has a 65% economic interest.
- 10 BHP (Non-JV) mineral resources are those that are wholly attributable to BHP.
- 11 Samarco mineral resources estimates, in which BHP has a 50% interest, were based on an iron price of US\$130.18. The point of reference for the mineral resources was in situ.

## Mineral reserves

As at 30 June 2024

Iron ore <sup>1</sup>	Mining method	Proven Mineral Reserves						Probable Mineral Reserves						Total Mineral Reserves					
		Tonnage Mt	%Fe	%P	Qualities %SiO <sub>2</sub>	%Al <sub>2</sub> O <sub>3</sub>	%LOI	Tonnage Mt	%Fe	%P	Qualities %SiO <sub>2</sub>	%Al <sub>2</sub> O <sub>3</sub>	%LOI	Tonnage Mt	%Fe	%P	Qualities %SiO <sub>2</sub>	%Al <sub>2</sub> O <sub>3</sub>	%LOI
<b>Australia</b>																			
<b>WAIO<sup>2,3,4,5,6,7</sup></b>																			
Mt Newman	OC	190	62.9	0.12	3.6	2.0	3.5	490	61.3	0.12	3.9	2.3	5.4	680	61.7	0.12	3.8	2.2	4.9
Goldsworthy <sup>8</sup>	OC	840	61.7	0.10	3.5	1.9	5.8	910	60.9	0.08	4.1	1.9	6.4	1,750	61.3	0.09	3.8	1.9	6.1
Jimblebar	OC	710	61.4	0.11	3.9	2.6	4.9	580	60.4	0.12	4.7	2.7	5.4	1,290	61.0	0.12	4.3	2.7	5.1
<b>WAIO Total</b>		<b>1,740</b>	<b>61.7</b>	<b>0.11</b>	<b>3.7</b>	<b>2.2</b>	<b>5.2</b>	<b>1,980</b>	<b>60.9</b>	<b>0.10</b>	<b>4.2</b>	<b>2.2</b>	<b>5.9</b>	<b>3,720</b>	<b>61.3</b>	<b>0.10</b>	<b>4.0</b>	<b>2.2</b>	<b>5.5</b>
<b>Brazil</b>																			
Samarco <sup>9</sup>	OC	49	40.7	0.07	–	–	–	376	43.0	0.05	–	–	–	425	42.7	0.06	–	–	–
<b>Total iron ore</b>		<b>1,790</b>	<b>61.1</b>	<b>–</b>	<b>–</b>	<b>–</b>	<b>–</b>	<b>2,360</b>	<b>58.0</b>	<b>–</b>	<b>–</b>	<b>–</b>	<b>–</b>	<b>4,150</b>	<b>59.4</b>	<b>–</b>	<b>–</b>	<b>–</b>	<b>–</b>

1 Mineral reserves are reported in this report in accordance with S-K 1300 and are presented for the portion attributable to BHP's economic interest in the respective joint ventures. All tonnes and quality information have been rounded, small differences may be present in the totals.

2 WAIO is considered a material property for purposes of Item 1304 of S-K 1300. BHP interest is 85% for all joint ventures included in this table.

3 WAIO mineral reserves qualities are presented as in situ mass percentage on a dry weight basis and tonnage as wet tonnes. Moisture content is based on deposit types, Brockman (BKM) – 3% and Marra Mamba (MM) – 4%.

4 WAIO point of reference for the mineral reserves was as delivered to the ore handling/process plant.

5 WAIO mineral reserves estimates were based on an iron ore price of US\$116/dmt for Platts 62% Fe Fines Index and US\$123/dmt for lump, both FOB Port Hedland basis.

6 WAIO joint ventures include Brockman (BKM) and Marra Mamba (MM) deposit types. All mineral reserves estimates applied a cut-off criteria of 58% Fe.

7 WAIO is predominantly a producer of direct shipping ore and the metallurgical recovery was assumed as 99% for Mt Newman and 100% for Goldsworthy and Jimblebar joint ventures.

8 Goldsworthy joint venture includes 1 Mt proven and 0.4 Mt of probable mineral reserves from the POSMAC joint venture in which BHP has a 65% economic interest.

9 Samarco mineral reserves, in which BHP has a 50% interest, were based on an iron price of US\$126.68. The point of reference for the mineral reserves was to the ore handling/process plant.

## 6.4 WAIO individual property disclosure

### 6.4.1 Property description

WAIO is a production-stage property with mines located in the Pilbara iron ore province in the north-west of Western Australia (WA), Australia and is centred on the regional town of Newman located approximately 1,000 km north of WA's capital city Perth. The property is accessible from Perth by road via the Great Northern Highway and by air via regular commercial flights to Newman.

Mines, processing facilities, railways and port facilities comprising WAIO are spread over a geographical area of 350 km N-S and 250 km E-W between Port Hedland and Newman towns in the Pilbara region.

The geographic coordinates of the central points of the five mines are provided below and their locations shown below.

- Newman: Latitude: 23°21'40" S, Longitude: 119°40'15" E
- Jimblebar: Latitude: 23°22'40" S, Longitude: 120°07'45" E
- Mining Area C: Latitude: 22°55'30" S, Longitude: 118°58'55" E
- South Flank: Latitude: 22°59'35" S, Longitude: 118°59'45" E
- Yandi: Latitude: 22°43'15" S, Longitude: 119°05'15" E

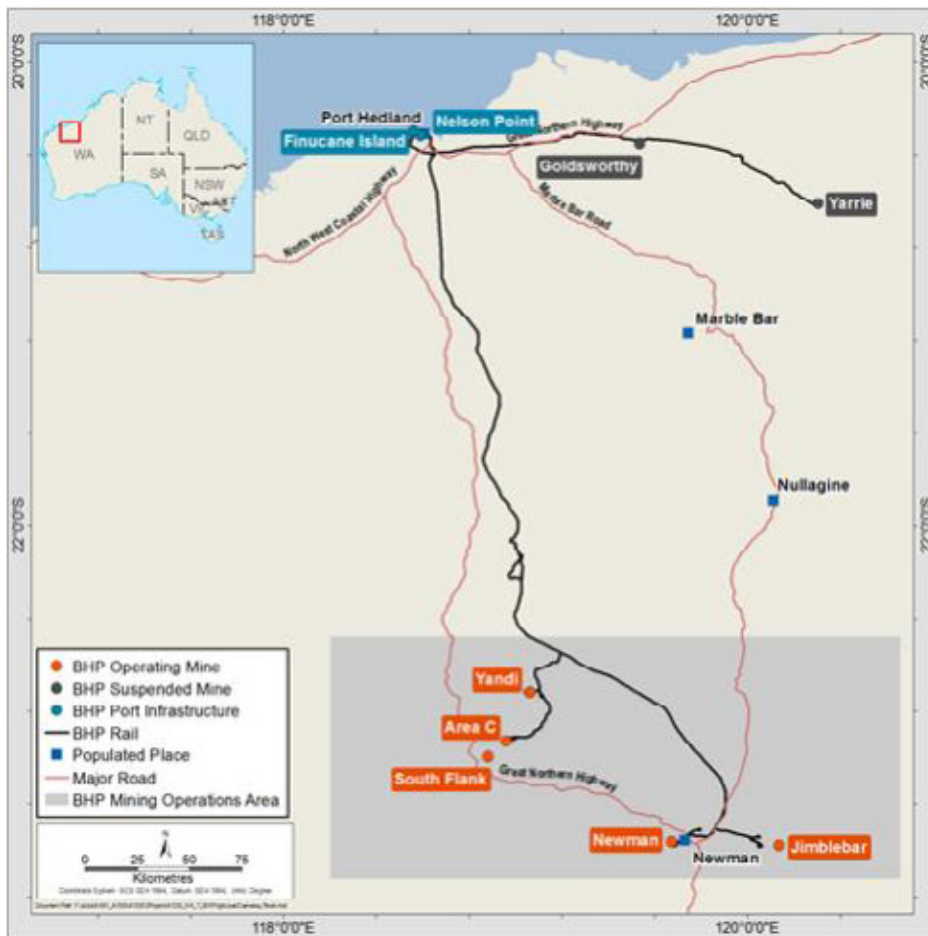

## 6.4.2 Infrastructure

Most of the infrastructure required for WAIO to support the current mining operations including roads, airport, rail and port, power and water supply is in place. These have been developed by BHP gradually over the last six decades in pace with staged expansion of production capacity.

WAIO's mines (Newman, Jimblebar, Mining Area C, South Flank and Yandi) and processing hubs (Newman, Jimblebar, Mining Area C and Yandi) are connected to its two ports (Nelson Point and Finucane Island) located at Port Hedland by a network of more than 1,000 km of rail infrastructure.

The mines have a network of BHP owned roads to service the mining operations and connect to the Great Northern Highway.

Water is sourced from ground water supplies for all WAIO mines, process plants and mine camps. These water supplies are drawn from BHP managed bore fields around mine sites established by WAIO under license for its operations and mine camps. Port Hedland operations are supplied water under contract from the municipal provider, sourced from nearby coastal aquifers.

WAIO has a natural gas-fired power plant (Yarnima Power Station, in Newman town), with an installed generator capacity for 190 megawatt. The plant supplies the entire power requirement for all its mining, processing facilities and mine camps. Power consumed for WAIO's port operations at Port Hedland is purchased via a power purchase agreement with APA Energy (formerly Alinta Energy), a large energy supplier in Australia.

BHP has set up its own accommodation villages / camps at the mines to accommodate its fly-in-fly-out (FIFO) personnel. In addition to the commercial airport at Newman, BHP has set up private airports at mine sites and operates regular charter flights from Perth directly to transport FIFO workforce.

WAIO relies mainly on FIFO workforce sourced primarily from within Western Australia (Perth and other regional towns) and to a lesser extent from other states in Australia.

## 6.4.3 Mineral tenure

BHP and its joint venture partners hold mineral rights in 66 mineral titles covering a total area of approximately 4,683 km<sup>2</sup>. Of this, approximately 2,845 km<sup>2</sup> is contributed by eight mineral titles held pursuant to five State Agreement Acts of the state of Western Australia and the remaining area (1,838 km<sup>2</sup>) by 58 mineral titles held pursuant to the Mining Act, 1978 (Western Australia).

The five State Agreement Acts (incorporating agreements between BHP along with its joint venture partners and the state of Western Australia) are ratified by the parliament of Western Australia and provide WAIO long-term tenure security for mineral development. These acts and details of mining titles held pursuant to each State Agreement are provided in the list and table below.

1. Iron Ore (Mount Newman) Agreement Act 1964 (WA) - ML244SA held by the Mount Newman Joint Venture.
2. Iron Ore (Mount Goldsworthy) Agreement Act 1964 (WA) - ML235SA, ML249SA and ML281SA held by the Mount Goldsworthy Joint Venture.
3. Iron Ore (Goldsworthy-Nimingarra) Agreement Act 1972 (WA) - M263SA and ML251SA held by the Mount Goldsworthy Joint Venture.
4. Iron Ore (McCamey's Monster) Agreement Authorisation Act 1972 (WA) - M266SA held by BHP Iron Ore (Jimblebar) Pty Ltd.
5. Iron Ore (Marillana Creek) Agreement Act 1991 (WA) - M270SA held by the Yandi Joint Venture.

Lease number	Registered tenement holders <sup>1</sup> / interest	Grant date	Expiry date <sup>2</sup>	Legal area (km <sup>2</sup> )	Rent and rate <sup>4</sup> (AU\$)
M263SA	BHP (85%), Itochu (8%), Mitsui (8%)	22/01/1989	21/09/2035	143.23	355,540.25
M266SA	BHPIOJ (100%) <sup>(3)</sup>	11/10/1988	10/10/2030	526.06	130,412.06
M270SA	BHP (85%), Itochu (8%), Mitsui (8%)	4/09/1991	3/09/2033	303.44	1,957,254.44
ML235SA	BHP (85%), Itochu (8%), Mitsui (8%)	5/08/1965	4/08/2028	41.42	3,109.11
ML244SA	BHP (85%), M-Itochu (10%), Itochu (5%)	7/04/1967	6/04/2030	789.34	123,629.35
ML249SA	BHP (85%), Itochu (8%), Mitsui (8%)	8/05/1974	4/08/2028	306.47	24,364.41
ML251SA	BHP (85%), Itochu (8%), Mitsui (8%)	22/09/1972	21/09/2035	171.30	86,058.00
ML281SA	BHP (85%), Itochu (8%), Mitsui (8%)	26/04/2002	4/08/2028	563.35	158,201.82

<sup>1</sup> Full legal entity names of the registered tenement holders are: (i) BHP: BHP Billiton Minerals Pty Ltd, (ii) M-Itochu: Mitsui-Itochu Iron Pty Ltd, (iii) Itochu: Itochu Minerals & Energy of Australia Pty Ltd, (iv) Mitsui: Mitsui Iron Ore Corporation Pty Ltd and (v) BHPIOJ: BHP Iron Ore (Jimblebar) Pty Ltd.

<sup>2</sup> All State Agreement Act leases, except M270SA, have right to successive renewals of 21 years each. M270SA has right to only two renewals, each for 21 years ultimately expiring in 2054, from which point the lease would revert to a Mining Act lease, subject to prior renegotiation between BHP and the State Government.

<sup>3</sup> M266SA is held by BHP Iron Ore (Jimblebar) Pty Ltd, a subsidiary of BHP Minerals Pty Ltd (BHP). In 2013, BHP entered into an incorporated Joint Venture (Jimblebar IJV) with Itochu and Mitsui in respect of the Jimblebar mining hub, owned by BHP Iron Ore (Jimblebar) Pty Ltd (BHPIOJ). The Jimblebar IJV is structured so that BHP, Itochu and Mitsui hold A Class Shares in BHPIOJ, which confer an 85:8:7 economic interest, respectively in the “Jimblebar Assets”, being certain assets of BHPIOJ including the Jimblebar mine. BHPIOJ also owns other assets, called “Excluded Assets”, in which BHP alone holds a 100% economic interest through B Class Shares in BHPIOJ.

<sup>4</sup> Statutory Rents and Rates are payable annually to the State Government and the Local Government/Shire respectively.

As at 30 June 2024, all of WAIO’s mineral reserves and 85% of mineral resources (exclusive of mineral reserves) were located on the eight mineral titles held pursuant to the five State Agreement Acts. The remaining 15% of mineral resources are located across the 58 tenements held pursuant to the Mining Act. All mineral development and extraction activities are currently being undertaken only within tenements held pursuant to the State Agreement Acts. Activities within the Mining Act tenements are currently limited to exploration work aimed at defining mineral resources.

#### **6.4.4 Registrant interest**

In addition to being the majority owner of the property, BHP holds one royalty stream which entitles BHP to earn royalty income in relation to ore produced only from Mining Area C and South Flank. This royalty stream contributed 0.1% of free on board (FOB) revenue in FY2024.

#### **6.4.5 Present condition of property**

WAIO is a production-stage property with a large base of mineral reserves and mineral resources.

Exploration activities have been ongoing on the property since the 1950s. Drilling is the primary method for exploration and sampling. From the 1950s to December 2023, WAIO had completed over 152,000 exploration drill holes for a total of 12,070 km, including 8,870 km reverse circulation and 809 km diamond core drilling, across its tenements for the purpose of resource identification and definition, resource characterization, modelling of geotechnical and hydrogeological parameters, and geometallurgical test work. For the past 15 years, annually 400 to 600 km of drilling was carried out.

The exploration activities have occurred in areas adjacent to operating mines (brownfield areas) to replenish mineral resources depleted by mine production. In addition, some exploration activities have been completed in strategic greenfield areas to provide optionality for future development.

All mines are open cut, with ore extracted using excavator and truck. After extraction, the ore is crushed before train loading and transporting to the port for direct shipping.

#### **6.4.6 Physical condition**

Production on the WAIO property started in late 1960s from one mine. Currently there are five operating mines, Newman, Yandi, Mining Area C, Jimblebar and South Flank, started in 1969, 1992, 2003, 2013 and 2021, respectively.

Yandi mine has started its end-of-life production ramp down, closure and decommissioning of associated infrastructure commenced in July 2021.

The operations undertake planned maintenance programs and implement scheduled replacement of equipment and infrastructure that is required to maintain the continued reliable operation of the mines and supporting services such as power, port facilities, water supplies and rail.

Modernisation of rail operations and automation of haul trucks are currently in progress.

#### 6.4.7 Book value

The total book value of the WAIO property and its associated plant and equipment was US\$16.0 billion on equity ownership basis, as of 30 June 2024.

#### 6.4.8 History of previous operations

Since the 1950s, BHP has been continuously exploring, developing and extracting iron ore at gradually increasing rates of production to keep pace with global sea-borne market demands.

In 1966, BHP's joint venture partner Goldsworthy Mining Limited (GML) was the first company to develop an iron ore mine in the Pilbara. The mine, Mount Goldsworthy ceased operations in 1982 with production entirely for export purposes. BHP was initially a joint venture partner in GML and acquired the full ownership of GML in 1990.

In 1969, BHP developed the Mount Whaleback deposit at Newman entirely for export purposes as a part of the Mount Newman Mining Joint Venture (NJV). The majority ownership of NJV was acquired by BHP in 1986.

In 1991, BHP developed the Yandi deposit and in 1992 acquired the Jimblebar deposits. In the 1990s, subleases tied to ore purchase agreements by a Chinese consortium over part of the Jimblebar deposits and by South Korea's POSCO for C Deposit at Mining Area C increased BHP's annual production.

Since the 1990s to present day, BHP has been expanding production from its five mining hubs, Newman, Jimblebar, Mining Area C, South Flank and Yandi. South Flank commenced production in May 2021 to replace Yandi production. Yandi is decreasing production towards closure and decommissioning of infrastructure.

#### 6.4.9 Significant encumbrances

BHP is not aware of any significant encumbrances to the property, including current and future permitting requirements and associated timelines or permit conditions.

#### 6.4.10 Geology and mineralisation

The WAIO iron ore deposits are hosted in the late Archaean to early Proterozoic-age banded iron formations of the Hamersley Group in the Pilbara region of Western Australia. The two main hosts for bedrock mineralisation in the Hamersley Group are the Brockman and Marra Mamba iron formations.

Brockman Iron Formation tends to have higher phosphorous and alumina concentration (both deleterious elements) with a lower loss-on ignition than the Marra Mamba Iron Formation. These compositional differences are one of reasons for dividing the ore by stratigraphy. The bedded iron deposits are further subdivided in terms of their genesis and mineralogy into hypogene martite-microplaty hematite and supergene martite-geothite ores.

Widespread detrital sequences occur adjacent to the bedded iron deposits in the form of colluvial-alluvial fans. The detrital deposits economic value depends on the size and concentration and are mostly exploited when associated with bedrock deposits.

In addition, mineralisation is found in fluvial channel iron deposits of the late Eocene to early Miocene age. The iron content in the channel iron deposits tends to be lower than the bedrock mineralisation, however, they tend to be lower in phosphorous and alumina.

The primary iron bearing minerals are hematite and goethite which vary in concentration within the deposits.

Mineralisation extends over strike lengths of 5-10 km for most deposits, however, may extend for up to 50-60 km. The width of mineralisation at surface typically ranges from about 200 m up to 1500 m. Mineralisation extends to depths of between 100 m and 400 m and deposits typically have some form of surface expression.

#### 6.4.11 Mineral resources and mineral reserves

Tables of mineral resources and mineral reserves for WAIO reported by joint venture are included in section 6.3 above.

#### 6.4.12 Changes to mineral resources and mineral reserves

Total mineral resources as at 30 June 2024 were 13,850 Mt compared to the previous year as at 30 June 2023 which were 14,890 Mt, a decrease of 7% (-1,040 Mt). The changes were mainly due to conversion of resources to reserves and reasonable prospect of economic extraction assessment.

Total mineral reserves as at 30 June 2024 were 3,720 Mt compared to the previous year as at 30 June 2023 which were 3,440 Mt, an increase of 8% (280 Mt). The changes were mainly due to conversion of resources to reserves.

#### 6.4.13 Material assumptions and criteria

Mineral resources estimated for WAIO's active mines and undeveloped deposits consider the following assumptions:

- Resources estimated using ordinary kriging and inverse distance weighted methods.
- Resources are reported exclusive of mineral reserves and are presented as in situ estimates.
- Resources are reported on a wet tonnage basis for all deposit types associated with the joint ventures.
- Standard open cut practices are assumed for all ore extraction.
- Resources are excluded from reporting as appropriate for heritage, environmental, hydrological, tenure, and infrastructure purposes to minimise any potential impacts.

Mineral reserves are estimated for WAIO's active mining areas and considers the following assumptions:

- The latest and approved resource models and mineral resource estimates have been used for mine planning and conversion to mineral reserves by application of all relevant modifying factors.
- The resource models are converted to mining models (WAIO equivalent of a "reserve" model) by regularising the resource model blocks to SMU-sized blocks
- The average of the previous three years (FY2021 to FY2023) actual yearly operating and capital costs are used to estimate the cut-off grades and mineral reserves.
- The median of the three-year trailing calendar monthly average iron ore prices from July 2020 to June 2023 are used to estimate the cut-off grades and mineral reserves.
- Mineral reserves are estimated using conventional open-cut mining method involving drill and blast with load and haul activities.
- Pit optimisations are completed to determine economic pit limits using industry standard Lerch-Grossman algorithm.
- Mine designs including pit, waste dumps and haul roads are generated in industry standard CAD software. The designs incorporate the minimum mining width based on the equipment and slope design parameters from geotechnical models.
- WAIO's run-of-mine (ROM) ore is direct shipping ore without the need of concentration or beneficiation. The processing method involves simple crushing and screening of the ore to produce lump and fines products.

Details of the material assumptions are described in the Technical Report Summary (effective 30 June 2022) incorporated as an exhibit to the Annual Report by reference to the exhibit to the Annual Report on Form 20-F for the year ended 30 June 2023, sections 11 Mineral Resource Estimates, 12 Mineral Reserve Estimates, 13 Mining Methods, 14 Processing and Recovery Methods and 18 Capital and Operating Costs.

## 6.5 Steelmaking coal

### Coal resources<sup>1</sup>

As at 30 June 2024

Steelmaking coal <sup>2,3</sup>	Mining method	Measured Coal Resources				Indicated Coal Resources				Measured + Indicated Coal Resources				Inferred Coal Resources			
		Tonnage Mt	%Ash	%VM	%S	Tonnage Mt	%Ash	%VM	%S	Tonnage Mt	%Ash	%VM	%S	Tonnage Mt	%Ash	%VM	%S
Australia																	
BMA <sup>4,5,6</sup>	OC & UG	1,023	9.9	18.6	0.59	544	10.7	18.0	0.67	1,567	10.1	18.3	0.62	438	11.1	19.1	0.66
<b>Total steelmaking coal</b>		<b>1,023</b>	<b>9.9</b>	<b>18.6</b>	<b>0.59</b>	<b>544</b>	<b>10.7</b>	<b>18.0</b>	<b>0.67</b>	<b>1,567</b>	<b>10.1</b>	<b>18.3</b>	<b>0.62</b>	<b>438</b>	<b>11.1</b>	<b>19.1</b>	<b>0.66</b>

1 Coal resources is used as an equivalent term to mineral resources.

2 Coal resources are reported in this report in accordance with S-K 1300 and are presented for the portion attributable to BHP's economic interest in the respective joint venture. All tonnes and quality information have been rounded, small differences may be present in the totals.

3 Coal resources are presented exclusive of coal reserves.

4 BMA mineral resources, in which BHP has a 50% interest, includes Goonyella Complex, Caval Ridge, Peak Downs, Saraji and Saraji South deposits.

5 The point of reference for the coal resources tonnage estimates was in situ. Coal qualities are reported for a clean coal simulated product on an air-dried basis.

6 Coal resources estimates comprise 95% metallurgical and 5% thermal coal product categories. Coal resources prices used for each of the coal categories were hard coking coal US\$353.09/t and thermal coal US\$331.41/t.

### Coal reserves<sup>1</sup>

As at 30 June 2024

Steelmaking coal <sup>2</sup>	Mining Method	Proven Coal Reserves	Probable Coal Reserves	Total Coal Reserves	Proven Marketable Coal Reserves				Probable Marketable Coal Reserves				Total Marketable Coal Reserves			
		Tonnage Mt	Tonnage Mt	Tonnage Mt	Tonnage Mt	%Ash	%VM	%S	Tonnage Mt	%Ash	%VM	%S	Tonnage Mt	%Ash	%VM	%S
Australia																
BMA <sup>3,4,5,6</sup>	OC & UG	741	114	855	480	9.9	21.2	0.58	66	10.4	22.8	0.69	545	10.0	21.4	0.59
<b>Total steelmaking coal</b>		<b>741</b>	<b>114</b>	<b>855</b>	<b>480</b>	<b>9.9</b>	<b>21.2</b>	<b>0.58</b>	<b>66</b>	<b>10.4</b>	<b>22.8</b>	<b>0.69</b>	<b>545</b>	<b>10.0</b>	<b>21.4</b>	<b>0.59</b>

1 Coal reserves is used as an equivalent term to mineral reserves.

2 Coal reserves are reported in this report in accordance with S-K 1300 and presented for the portion attributable to BHP's economic interest in the respective joint venture. All tonnes and quality information have been rounded, small differences may be present in the totals.

3 BMA mineral reserves, in which BHP has a 50% interest, includes Goonyella Complex, Caval Ridge, Peak Downs, Saraji and Saraji South deposits.

4 Total coal reserves were at a 4% moisture content when mined. Total marketable reserves were at a product specification moisture content (9.5-10% Goonyella Complex; 10.5% Peak Downs; 10.5% Caval Ridge; 10.1% Saraji; 10-11% Saraji South) and at an air-dried quality basis for sale after the beneficiation of the total coal reserves.

5 The point of reference for the coal reserves was delivery to the coal handling and processing plants.

6 Coal reserves estimates comprise 98% hard coking coal and 2% thermal coal product categories. Coal reserves prices used for each of the coal categories were hard coking coal US\$253.58/t and thermal coal US\$174.04/t. These prices were converted from nominal to real basis aligned to the valuation date and site-specific factors were applied, based on changes in forecast quality over time, before coal reserves were estimated.



## 6.6 Energy coal

### Coal resources<sup>1</sup>

As at 30 June 2024

Energy coal <sup>2,3</sup>	Mining method	Measured Coal Resources					Indicated Coal Resources					Measured + Indicated Coal Resources					Inferred Coal Resources					
		Tonnage Mt	%Ash	%VM	%S	Kcal/kgCV	Tonnage Mt	%Ash	%VM	%S	Kcal/kgCV	Tonnage Mt	%Ash	%VM	%S	Kcal/kgCV	Tonnage Mt	%Ash	%VM	%S	Kcal/kgCV	
Australia																						
NSWEC <sup>4,5,6,7</sup>	OC	5.5	19.0	29.6	0.66	6,170	0.1	19.7	29.3	0.54	6,060	5.6	19.2	29.5	0.63	6,130	6.5	23.3	28.8	0.49	5,700	
<b>Total energy coal</b>		<b>5.5</b>	<b>19.0</b>	<b>29.6</b>	<b>0.66</b>	<b>6,170</b>	<b>0.1</b>	<b>19.7</b>	<b>29.3</b>	<b>0.54</b>	<b>6,060</b>	<b>5.6</b>	<b>19.2</b>	<b>29.5</b>	<b>0.63</b>	<b>6,130</b>	<b>6.5</b>	<b>23.3</b>	<b>28.8</b>	<b>0.49</b>	<b>5,700</b>	

<sup>1</sup> Coal resources is used as an equivalent term to mineral resources.

<sup>2</sup> Coal resources are reported in this report in accordance with S-K 1300 and are presented for the portion attributable to BHP's economic interest. All tonnes and quality information have been rounded, small differences may be present in the totals.

<sup>3</sup> Coal resources are presented exclusive of coal reserves.

<sup>4</sup> NSWEC, in which BHP has a 100% interest, includes Mt Arthur Coal deposit.

<sup>5</sup> Coal qualities are reported on an air-dried in situ basis. Tonnages are reported as in situ.

<sup>6</sup> The point of reference for the coal resources was in situ.

<sup>7</sup> Coal resources estimates were based on the average three-year historic thermal coal price of US\$331.41/t specification Newcastle Free On Board (FOB), 6,000 kcal/t net as received.

### Coal reserves<sup>1</sup>

As at 30 June 2024

Energy coal <sup>2</sup>	Mining Method	Proven Coal Reserves	Probable Coal Reserves	Total Coal Reserves	Proven Marketable Coal Reserves					Probable Marketable Coal Reserves					Total Marketable Coal Reserves					
		Tonnage Mt	Tonnage Mt	Tonnage Mt	Tonnage Mt	%Ash	%VM	%S	Kcal/kgCV	Tonnage Mt	%Ash	%VM	%S	Kcal/kgCV	Tonnage Mt	%Ash	%VM	%S	Kcal/kgCV	
Australia																				
NSWEC <sup>3,4,5,6</sup>	OC	69	35	104	51	15.5	30.5	0.51	5,910	26	15.5	30.3	0.51	5,910	77	15.5	30.4	0.51	5,910	
<b>Total energy coal</b>		<b>69</b>	<b>35</b>	<b>104</b>	<b>51</b>	<b>15.5</b>	<b>30.5</b>	<b>0.51</b>	<b>5,910</b>	<b>26</b>	<b>15.5</b>	<b>30.3</b>	<b>0.51</b>	<b>5,910</b>	<b>77</b>	<b>15.5</b>	<b>30.4</b>	<b>0.51</b>	<b>5,910</b>	

<sup>1</sup> Coal reserves is used as an equivalent term to mineral reserves.

<sup>2</sup> Coal reserves are reported in this report in accordance with S-K 1300 and are presented for the portion attributable to BHP's economic interest. All tonnes and quality information have been rounded, small differences may be present in the totals.

<sup>3</sup> NSWEC, in which BHP has a 100% interest, includes Mt Arthur Coal deposit.

<sup>4</sup> Coal qualities are presented as a potential product on an air-dried basis. Tonnages for the coal reserves are reported on an in situ moisture basis. Moisture when mined was 8.5% and for marketable reserves was 9.5%.

<sup>5</sup> The point of reference for the coal reserves was as delivered to the coal handling process plant.

<sup>6</sup> Coal reserves estimates were based on the average three-year historic thermal coal price of US\$170.04/t specification Newcastle FOB, 6,000 kcal/t net as received.

## 6.7 Potash

### Mineral resources

As at 30 June 2024

Potash <sup>1,2</sup>	Mining method	Measured Mineral Resources				Indicated Mineral Resources				Measured + Indicated Mineral Resources				Inferred Mineral Resources			
		Tonnage Mt	%K <sub>2</sub> O	%Insol.	%MgO	Tonnage Mt	%K <sub>2</sub> O	%Insol.	%MgO	Tonnage Mt	%K <sub>2</sub> O	%Insol.	%MgO	Tonnage Mt	%K <sub>2</sub> O	%Insol.	%MgO
Canada																	
Jansen <sup>3,4,5,6,7,8,9</sup>																	
LPL	UG	–	–	–	–	–	–	–	–	–	–	–	–	–	–	–	–
<b>Total potash</b>		<b>–</b>	<b>–</b>	<b>–</b>	<b>–</b>	<b>–</b>	<b>–</b>	<b>–</b>	<b>–</b>	<b>–</b>	<b>–</b>	<b>–</b>	<b>–</b>	<b>–</b>	<b>–</b>	<b>–</b>	<b>–</b>
		<b>1,280</b>	<b>25.6</b>	<b>7.7</b>	<b>0.08</b>												

1 Mineral resources are reported in this report in accordance with S-K 1300 and are presented for the portion attributable to BHP's economic interest. All tonnes and quality information have been rounded, small differences may be present in the totals.

2 Mineral resources are presented exclusive of mineral reserves.

3 Jansen, in which BHP has a 100% interest, is considered a material property for the purposes of Item 1304 of S-K 1300.

4 The point of reference for the mineral resources was in situ.

5 Mineral resources estimates were based on a potash price of US\$391/t (real basis). The primary basis was Nutrien's quarterly published offshore and onshore realised price from 2008 to 2023.

6 Mineral resources are stated for the Lower Patient Lake (LPL) potash unit and using a seam thickness of 3.96 m from the top of 406 clay seam.

7 Mineral resources are based on the expected metallurgical recovery of 88%.

8 Potash or sylvite (KCl) content of the deposit is reported in potassium oxide form (K<sub>2</sub>O). The conversion from KCl to K<sub>2</sub>O uses a mineralogical conversion factor of 1.583.

9 Mineral resources tonnages are reported on an in situ moisture content basis and was estimated to be 0.3%.

### Mineral reserves

As at 30 June 2024

Potash <sup>1</sup>	Mining method	Proven Mineral Reserves				Probable Mineral Reserves				Total Mineral Reserves			
		Tonnage Mt	%K <sub>2</sub> O	%Insol.	%MgO	Tonnage Mt	%K <sub>2</sub> O	%Insol.	%MgO	Tonnage Mt	%K <sub>2</sub> O	%Insol.	%MgO
Canada													
Jansen <sup>2,3,4,5,6,7,8</sup>													
LPL	UG	–	–	–	–	1,070	24.9	7.5	0.10	1,070	24.9	7.5	0.10
<b>Total potash</b>		<b>–</b>	<b>–</b>	<b>–</b>	<b>–</b>	<b>1,070</b>	<b>24.9</b>	<b>7.5</b>	<b>0.10</b>	<b>1,070</b>	<b>24.9</b>	<b>7.5</b>	<b>0.10</b>

1 Mineral reserves are reported in this report in accordance with S-K 1300 and are presented for the portion attributable to BHP's economic interest. All tonnes and quality information have been rounded, small differences may be present in the totals.

2 Jansen, in which BHP has a 100% interest, is considered a material property for the purposes of Item 1304 of S-K 1300.

3 The point of reference for the mineral reserves was ore as delivered to the mill for processing.

4 Mineral reserves estimates were based on a potash price of US\$391/t (real basis). The primary basis was Nutrien's quarterly published offshore and onshore realised price from 2008 to 2023.

5 Mineral reserves estimates cut-off is a function of mining parameters and seam thickness. The calculated cut-off grade from economic modelling where the mine plan would be break-even is 8.1% K<sub>2</sub>O.

6 Mineral reserves are based on the expected metallurgical recovery of 88%.

7 Potash or sylvite (KCl) content of the deposit is reported in potassium oxide form (K<sub>2</sub>O). The conversion from KCl to K<sub>2</sub>O uses a mineralogical conversion factor of 1.583.

8 Mineral reserves tonnages are reported on an in situ moisture content basis and was estimated to be 0.3%.

## 6.8 Jansen individual property disclosure

### 6.8.1 Property description

The Jansen potash project is located in the rural municipalities of Leroy and Prairie Rose in the province of Saskatchewan, Canada, approximately 150 kilometres east of the city of Saskatoon.

The geographic coordinate location for the service shaft is Latitude 51°53'56.62"N and Longitude 104°42'53.44"W.



### 6.8.2 Infrastructure

The site is accessed by road from provincial Highway 16 approximately 12 kilometres to the south and Highway 5 approximately 32 kilometres to the north. Access to the mine site from these highways uses upgraded secondary and/or primary roads from the village of Jansen to the south and the town of Leroy to the north. The nearest commercial airport is in the city of Saskatoon.

Communications, power, water, and natural gas are provided by provincial crown corporations. The pipeline connection to the Saskatoon South East Water Supply system for Jansen's primary water use is complete. The natural gas supply pipeline has been installed. The permanent 230 kV power supply has been constructed and commissioned.

The Jansen site has two mine shafts, the service shaft and the production shaft. The service shaft permanent headframe, hoist houses, and collar house are constructed. The production shaft sinking headframe and ground mounted drum winders are installed and in use.

A third-party rail provider is expected to transport the potash produced from the Jansen site to the port terminal, located in Delta, British Columbia, Canada, which is owned and operated by a third-party provider. The port facility will unload the railcars, store the product, and load shipping vessels.

The processing facilities to be constructed at Jansen include:

- Raw ore handling, storage and crushing;
- Process mill building wet area comprising attrition scrubbing, de-sliming, flotation and de-brining;
- Process mill building dry area comprising drying, screening, compaction and glazing;
- Tailings processing and reagents;
- Product handling, storage and load out.

Employees of Jansen mine are anticipated to reside in several existing communities located in the area.

### 6.8.3 Mineral tenure

The total area of the Jansen project lease is approximately 1,156 km<sup>2</sup>. Most mineral rights parcels are owned by the Saskatchewan Crown, the remaining mineral parcels are owned by individuals or corporations. To gain access to the potash within mineral parcels owned by individuals or corporations ('freehold mineral lease'), BHP must either purchase the mineral parcels or negotiate mineral lease agreement(s) with the registered owner(s) of the mineral parcel(s). The freehold mineral leases secured by BHP have a term of 21 years and are renewable at the option of BHP for successive terms of 21 years. An annual rental payment of CA\$4.94/hectare is also paid to keep these leases in good standing.

All surface lands that form part of the Jansen mine operations footprint have been acquired by BHP Canada.

On 23 November 2012, the Government of Saskatchewan and BHP Canada entered into Potash Lease Special Agreement KLSA 011. This agreement gives BHP Canada the exclusive right to search for, dig, work, mine, extract, recover, process, and carry away subsurface minerals under or within all of the Saskatchewan Crown mineral parcels of KLSA 011. The lease pertains to two categories of lands, 'KLSA 011 Core Lands' comprising primarily the mineral reserves and 'KLSA 011 Expansion Lands', and additional area outside mineral reserves that includes the primarily inferred resources.

During the first three years of KLSA 011, BHP was required to complete CA\$12 million of work on the lease area. This work commitment has been met.

Lease description	Area (ha)	%	Expiry date	Annual lease payment <sup>1</sup>
Jansen project total lease area	115,638	100		
KLSA 011 Core lands	63,939.43	55	22/11/2033	1,056,623.66
KLSA 011 Expansion lands	41,724.73	36	22/11/2033	
BHP acquired freehold mineral rights	8,997.56	8	Not applicable	
<b>Total of Core, Expansion, and acquired freehold mineral rights</b>	<b>114,661.72</b>	<b>99</b>		

<sup>1</sup> Annual lease payment in CA\$

### 6.8.4 Registrant interest

BHP does not hold any royalty in Jansen in addition to its economic interest of 100%.

### 6.8.5 Present condition of property

Jansen is currently in construction phase. A substantial portion of the site grading, drainage and road network is in place. The site is connected to natural gas supply, permanent electrical power, communication fibre and non-potable water. A 2,600 person construction camp has been constructed and in use. The service shaft and the production shaft have been excavated and hydrostatically lined. The service shaft permanent headframe, hoist houses, and collar house are constructed. The production shaft sinking headframe and ground mounted drum winders are installed and in use.

### 6.8.6 Physical condition

Jansen is a development stage property that is in the process of construction with board approval to proceed with Stage 2 announced in October 2023. Some permanent infrastructure is in place including site facilities, service and production shafts, along with temporary construction infrastructure. BHP has a construction program to complete all the necessary requirements such as installation of processing, underground development, mining equipment, rail and port facilities to enable the mine to commence operations.

### 6.8.7 Book value

The total book value for the Jansen property and its associated plant and equipment was US\$6.5 billion as of 30 June 2024.

### 6.8.8 History of previous operations

There is no history of previous operations on the Jansen project area.

### 6.8.9 Significant encumbrances

There have been no significant encumbrances to the property identified as of the date of this report. Federal, provincial, municipal permits and approval for construction and operation have been received. All material permits that have been applied for to-date have been received.

### 6.8.10 Geology and mineralisation

The Jansen potash deposit is located within the Williston Basin, a large, intracratonic, and horizontally bedded sedimentary basin that has not been subject to structural deformation, either faulting or folding.

The potash beds are hosted within the Prairie Evaporite Formation, in regionally extensive, horizontal layers created by the repeated, cyclical evaporation of a shallow, inland sea during the Devonian period. The potash deposit extends from east to west in the province and are relatively uniform, except where there are anomalies due to local alterations or disruption of the potash beds.

In the Jansen area, the potash is at a depth of 800 to 1,050 metres. Two potash members are present the Patience Lake and Belle Plaine members. The Patience Lake Member is further subdivided into Upper Patience Lake and Lower Patience Lake sub-members. The Lower Patience Lake sub-member is the potash horizon targeted for Jansen. The Lower Patience Lake sub-member is composed of sylvite (KCl), halite (NaCl) with variable amounts of disseminated insolubles and clay seams. Carnallite (KCl.MgCl<sub>2</sub>.6H<sub>2</sub>O), a mineral which can impact processing and ground stability, occasionally occurs in place of sylvite within the potash layer. Large carnallite zones can typically be mapped using 3D seismic survey information.

The Dawson Bay Formation includes the Second Red Beds Member and the Dawson Bay carbonate members which overlay the Prairie Evaporite Formation. The Dawson Bay Formation in the Jansen area is expected to have low permeability or relatively low inflow deliverability potential.

Approximately 400 metres below the Prairie Evaporite Formation are the Cambrian-Ordovician Winnipeg and Deadwood formations. Sediments of these formations were deposited in near shore, shallow water marine environments on top of the Precambrian rocks. The coarse to fine sands of the formations, host a vast deep saline aquifer that is used for brine disposal.

### 6.8.11 Mineral resources and mineral reserves

Tables of mineral resources and mineral reserves for Jansen reported by ore type are included in section 6.7 above.

### 6.8.12 Changes to mineral resources and mineral reserves

Total mineral resources as at 30 June 2024 has not changed from previous year, as at 30 June 2023 (1,280 Mt).

Total mineral reserves as at 30 June 2024 has not changed from previous year, as at 30 June 2023 (1,070 Mt).

### 6.8.13 Material assumptions and criteria

The key assumptions in the estimation of mineral resources are summarised as:

- Cut-off parameter of 3.96 m from the top of the 406 clay seam contact with the top of Lower Patience Lake sub-member, aligned with the mining equipment requirements.
- Geological anomalies identification including collapses representing potential water ingress hazards, carnallite anomalies impacting extraction and processing and no potash zones creating additional dilution.
- Exclusion zones sterilising sections of the reserves due to lease boundaries and around drill holes.
- Brine and solid salt waste estimate for disposal modelling into the aquifer and tailings management area.

The key assumptions in the estimation of mineral reserves are summarised as:

- The mining method will be continuous mining using long room and pillar method.
- Extraction ratios to reduce stress and provide room stability.
- Thickness of the roof salt beam (horizon) as potential planes of weakness, impacting amount of ground support or dilution estimates.
- Mine design layout maximising the Mineral Resource extraction based on estimated thicknesses, avoiding anomalies (collapse, massive carnallite and no potash zones) and salt beam modelling.
- Commodity price and operating costs.

Details of the material assumptions are described in the Technical Report Summary (effective 30 June 2024), incorporated as an exhibit to this Annual Report on Form 20-F for the year ended 30 June 2024, sections 11 Mineral Resource Estimates, 12 Mineral Reserve Estimates, 13 Mining Methods, 14 Processing and Recovery Methods and 18 Capital and Operating Costs.

## 7 People – performance data<sup>1,2,3</sup>

**Table 1 – Workforce data and diversity by region FY2024**

Region	Number and		Average number and		Employees by gender number and %			
	% of employees		% of contractors <sup>2</sup>		Male	Male %	Female	Female %
Asia	1,651	4.0	4,335	8.5	625	37.9	1,026	62.1
Australia	31,155	76.2	18,737	36.9	20,501	65.8	10,654	34.2
Europe	84	0.2	9	0.0	38	45.2	46	54.8
North America	693	1.7	1,537	3.0	362	52.2	331	47.8
South America	7,289	17.8	26,097	51.5	4,186	57.4	3,103	42.6
<b>Total</b>	<b>40,872</b>	<b>100.0</b>	<b>50,715</b>	<b>100.0</b>	<b>25,712</b>	<b>62.9</b>	<b>15,160</b>	<b>37.1</b>

**Table 2 – Employees by category and diversity for FY2024**

Employment category	Total	% of Total	Gender		Region				
			Male	Female	Asia	Australia	Europe	North America	South America
Full time	38,962	95.3	25,054	13,908	1,613	29,601	77	676	6,995
Part time	1,132	2.8	444	688	3	1,121	3	5	0
Fixed term full time	672	1.6	182	490	35	327	4	12	294
Fixed term part time	11	0.0	3	8	0	11	0	0	0
Casual	95	0.2	29	66	0	95	0	0	0
<b>Total</b>	<b>40,872</b>	<b>100.0</b>	<b>25,712</b>	<b>15,160</b>	<b>1,651</b>	<b>31,155</b>	<b>84</b>	<b>693</b>	<b>7,289</b>

**Table 3 – Employees by category and diversity for FY2024**

Category	Total	Gender		Gender %		Age group %			
		Male	Female	Male %	Female %	Under 30	30–39	40–49	50+
Senior leaders	262	158	104	60.3	39.7	0.0	6.9	51.9	41.2
Managers	1,369	828	541	60.5	39.5	0.4	23.4	51.2	25.1
Supervisory and professional	18,070	10,723	7,347	59.3	40.7	9.2	39.3	32.9	18.6
Operators and general support	21,171	14,003	7,168	66.1	33.9	20.1	28.7	25.2	26.0
<b>Total</b>	<b>40,872</b>	<b>25,712</b>	<b>15,160</b>	<b>62.9</b>	<b>37.1</b>	<b>14.5</b>	<b>33.0</b>	<b>29.7</b>	<b>22.8</b>

## Board and executive management diversity

In accordance with UK Listing Rule 14.3.30(2), these tables set out the Board and executive management diversity data as at 30 June 2024.

### Gender identity

	Number of Board members	Percentage of the Board	Number of senior positions on the Board (CEO, CFO, SID and Chair) <sup>4</sup>	Number in executive management <sup>5</sup>	Percentage of executive management <sup>5</sup>
Men	6	60%	3	5	45%
Women	4	40%	–	6	55%
Not specified/prefer not to say	0	0%	–	0	0%

### Ethnic background

	Number of Board members	Percentage of the Board	Number of senior positions on the Board <sup>4</sup>	Number in executive management <sup>5</sup>	Percentage of executive management <sup>5</sup>
White British or other White (including minority-white groups)	8	80%	2	7	64%
Mixed/Multiple ethnic groups	1	10%	1	3	27%
Asian/Asian British	1	10%	–	1	9%
Black/African/Caribbean/Black British	0	0%	–	0	0%
Other ethnic group	0	0%	–	0	0%
Not specified/prefer not to say	0	0%	–	0	0%

1. Based on a 'point-in-time' snapshot of employees as at 30 June 2024, including employees on extended absence, which was 1,146 in FY2024. There is no significant seasonal variation in employment numbers.

2. Contractor data is collected from internal organisation systems. Contractor data is averaged for a 10-month period, July 2023 to April 2024.

3. Figures reported do not include employees and contractors of BHP Billiton Mitsubishi Alliance Blackwater and Daunia operations, sold to Whitehaven Coal during FY2024. Figures reported do not include employees and contractors of the operations located in Brazil, that were acquired as part of the OZ Minerals acquisition completed during FY2023.

4. These tables are set out in the format prescribed by the UK Listing Rules. For BHP, the senior Board positions are the CEO, Senior Independent Director and Chair as the CFO is not a member of the Board, in line with market practice for Australian listed companies.

5. In accordance with the UK Listing Rules, executive management includes the Executive Leadership Team (the most senior executive body below the Board) and the Group Company Secretary, excluding administrative and support staff.

## 8 Legal proceedings

The Group is involved from time to time in legal proceedings and government investigations, including claims and pending actions against it seeking damages or clarification or prosecution of legal rights and regulatory inquiries regarding business practices. Insurance or other indemnification protection may offset the financial impact on the Group of a successful claim.

This section summarises the significant legal proceedings, investigations, and associated matters in which the Group is currently involved or has finalised since our last Annual Report.

### **Legal proceedings relating to the failure of the Fundão tailings dam at the Samarco iron ore operations in Minas Gerais and Espírito Santo (Samarco dam failure)**

The Group is engaged in numerous legal proceedings relating to the Samarco dam failure. While there has been progress in priority areas, such as individual compensation and indemnification for the damage caused by the dam failure, it is not possible at this time to provide a range of possible outcomes for all proceedings or a reliable estimate of potential future exposures. BHP Billiton Brasil Ltda. (BHP Brasil) is a party to approximately 42 ongoing public civil claims, of which 20 are suspended. The most significant of these proceedings are summarised in this section Additional information 8. There are numerous additional lawsuits against Samarco relating to the dam failure to which the Group is not a party.

### **Public civil actions brought by federal prosecutors and agreements**

Several legal proceedings have been brought by government authorities and civil associations claiming environmental and socioeconomic damages and a number of specific remediation measures as a result of the Samarco dam failure, including proceedings in which BHP Brasil is a defendant. Among the claims brought against BHP Brasil are:

- the public civil action brought by the Federal Government of Brazil, states of Espírito Santo and Minas Gerais and other public authorities against Samarco and its shareholders, BHP Brasil and Vale S.A. (Vale) in November 2015, seeking their joint liability for the full reparation of environmental and socioeconomic damages arising from the Samarco dam failure, in the amount of R\$20 billion (approximately US\$3.6 billion!) (the R\$20 billion Public Civil claim)



- the public civil action brought by the Brazilian Federal Public Prosecutors' Office against Samarco, BHP Brasil and Vale, as well as other public entities in May 2016, seeking R\$155 billion (approximately US\$27.9 billion<sup>1</sup>) for reparation, compensation and social, individual and collective moral damages in relation to the Samarco dam failure (the R\$155 billion Federal Public Prosecutors' Office claim)

A number of other proceedings to which BHP Brasil is a party are currently suspended due to their connection with the R\$20 billion Public Civil claim and R\$155 billion Federal Public Prosecutors' Office claim.

Samarco, Vale, BHP Brasil, and other public authorities have entered into agreements for the remediation of damages resulting from the Samarco dam failure.

- In March 2016, Samarco, BHP Brasil and Vale (Companies), entered into a Framework Agreement with the Federal Government of Brazil, the states of Espírito Santo and Minas Gerais and certain other public authorities to establish a foundation (Renova Foundation) to develop and execute environmental and socioeconomic programs (Programs) to remediate and provide compensation for damages caused by the Samarco dam failure. The term of the Framework Agreement is 15 years, renewable for periods of one year successively until all obligations under the Framework Agreement have been performed. Under the Framework Agreement, Samarco is responsible, as a primary obligor, for funding Renova Foundation's annual calendar year budget for the duration of the Framework Agreement. The amount of funding for each calendar year will depend on the remediation and compensation projects to be undertaken in a particular year and judicial decisions. To the extent that Samarco does not meet its funding obligations under the Framework Agreement, BHP Brasil and Vale have funding obligations under the Framework Agreement, as secondary obligors, each in proportion to its 50 per cent shareholding in Samarco in this section Additional Information 8.

- In June 2018, Samarco, BHP Brasil, Vale, the other parties to the Framework Agreement, the Public Prosecutors' Office<sup>2</sup> and the Public Defense Office<sup>3</sup> entered into a Governance Agreement (ratified by the Court on 8 August 2018), which settled the merits of the R\$20 billion Public Civil claim and established a process to renegotiate the Programs over two years to progress settlement of the R\$155 billion Federal Public Prosecutors' Office claim. Under the Governance Agreement, renegotiation of the Programs is based on certain agreed principles, including full reparation consistent with Brazilian law, the requirement for a technical basis for any proposed changes, consideration of findings from experts appointed by Samarco, BHP Brasil and Vale, consideration of findings from experts appointed by prosecutors and consideration of feedback from impacted communities.

In February 2021, the Minas Gerais State Prosecutor filed a public civil action against Samarco, BHP Brasil, Vale and Renova Foundation seeking the dissolution of Renova Foundation. The plaintiffs are seeking R\$10 billion (approximately US\$1.8 billion<sup>1</sup>) for moral damages. An injunction for the immediate intervention in Renova Foundation was also sought, alleging the need to preserve information and documents produced by Renova Foundation to evaluate criminal and civil responsibilities. A ruling on the merits is pending.

Since 7 January 2020, the Federal Court has issued several decisions creating 14 enforcement proceedings and ruled on several proceedings linked to the R\$20 billion Public Civil claim and R\$155 billion Federal Public Prosecutors' Office claim, including dismissal without prejudice of some of the requests and proceedings. Issues covered by these proceedings include, for example, environmental recovery, tailings management, human health risk and ecological risk, resettlement of affected communities, infrastructure and development, registration of certain impacted individuals under the Programs, monthly emergency financial aid, loss of profit and indemnities for people impacted by the Samarco dam failure, resumption of economic activities, water supply for human consumption and hiring of technical advisers to impacted people, Renova Foundation's governance and management system, and new areas allegedly affected by the dam failure, including freezing orders requests.

In October 2023, the Federal Court judge rendered a decision determining that the Interfederative Committee (IFC), which is an external and independent body responsible for supervising Renova Foundation and its programs, holds the final authority to determine technical issues concerning the reparation. This decision was confirmed by the Federal Court of Appeals in April 2024, which upheld that Renova Foundation and the Companies must comply with all IFC's directions, which are presumed to be valid and must prevail, unless the Companies and Renova Foundation can present clear proof that they are illegal. In January 2024, the Federal Court rendered a decision (25 January decision) that found Samarco, Vale and BHP Brasil jointly and severally liable to pay collective moral damages in the amount of R\$47.6 billion (approximately US\$8.6 billion<sup>1</sup>) (to be adjusted for interest and inflation). The decision ordered that no payment should occur until the decision is final and unappealable. In March 2024, the Federal Court found that the correct historical amount due of collective moral damages is R\$46.7 billion (instead of R\$47.6 billion). Samarco, Vale, and BHP Brasil appealed the decision challenging the merits and amount of damages. In May 2024, the various government parties filed interlocutory appeals to the 25 January decision seeking increased damages and the ability to enforce the judgment prior to it becoming final. The Federal Court judge and the Federal Court of Appeals issued rulings denying the requests for early enforcement. On 27 June 2024, the Federal Court judge dismissed without prejudice certain claims directed at the Companies in the R\$155 billion Federal Public Prosecutors' Office claim, on the grounds that they are already covered by previous agreements and decisions (such as the Framework Agreement). This decision did not dismiss the collective moral damages decision outlined above and is subject to appeal.

#### Footnotes

1. Based on the exchange rate as at 30 June 2024.
2. The Public Prosecutors' Office includes the Federal, State of Minas Gerais and State of Espírito Santo public prosecutors' offices.
3. The Public Defense Office includes the Federal, State of Minas Gerais and State of Espírito Santo public defense offices.

In June 2024, the Public Prosecutors' Office and the Public Defense Office filed a public civil claim against the Companies and Renova Foundation for alleged gender discrimination against women in the reparation process. They requested certain changes in Renova Foundation's registration program, damages and an injunctive relief to implement emergency measures. On 14 August 2024, the Federal Court partially granted the injunctive relief request and ordered Renova Foundation to allow the review of the registration of all women who are either registered or have pending registration applications in Renova Foundation. The decision is subject to appeal.

The parties have been engaging in negotiations to seek a definitive and substantive settlement of claims relating to the Samarco dam failure. The negotiations are ongoing and the outcome is uncertain. The potential liabilities resulting from current and future claims, lawsuits, proceedings, enforcement actions and Framework Agreement obligations relating to the Samarco dam failure, together with the potential cost of implementing remedies sought in the various proceedings, cannot be estimated with certainty at this time and there is a risk that outcomes may be materially higher or lower than amounts reflected in BHP Brasil's provision and contingencies for the Samarco dam failure.

**For more information on BHP Brasil's provision and contingencies for the Samarco dam failure refer to Financial Statements note 4 'Significant events – Samarco dam failure'**

#### **Civil public actions commenced by the State Prosecutors' Office in the state of Minas Gerais (Mariana CPA cases)**

The State Prosecutors of Mariana have commenced several civil public actions (CPAs) against Samarco, BHP Brasil and Vale.

On 10 December 2015, the State Prosecutors' Office in the state of Minas Gerais filed a CPA against Samarco, BHP Brasil and Vale before the State Court in Mariana claiming indemnification (amount not specified) for moral and material damages to an unspecified group of individuals affected by the Samarco dam failure, including the payment of costs for housing and social and economic assistance (CPA Mariana I).

On 2 October 2018, the parties reached a settlement dismissing the claim, which was ratified by the Court. Under this settlement, Renova Foundation has reached more than 100 individual agreements with impacted families in Mariana for the payment of damages.

In connection with CPA Mariana I, the State Prosecutors (Minas Gerais) started enforcement proceedings against Samarco, BHP Brasil and Vale. There are six enforcement proceedings under way, which among other things seek (i) to set a deadline for completion of resettlement of the residents of Mariana's districts and for fines to be imposed for delays to resettlement; (ii) to set the final term that will allow new households to join the resettlement; (iii) payment of compensation to affected individuals for delivery of houses below standard; (iv) to guarantee access to water sources for the families of the collective resettlements; (v) payment of fines for alleged delays in presenting proposals and making payments to affected individuals; and (vi) payment of compensation to impacted individuals who allege they have not yet received compensation and a penalty for the alleged delays in making such payments.

In addition to CPA Mariana I, the State Prosecutors (Minas Gerais) commenced other CPAs in Mariana against Samarco, BHP Brasil, Vale and, in some cases, Renova Foundation. The claims presented in those CPAs are related to damages that, according to the State Prosecutors, are not covered by CPA Mariana I.

As to those CPAs, there are proceedings that (i) have been settled by the parties, including BHP Brasil, (ii) have been dismissed or (iii) are still pending (9 in total). Renova Foundation is responsible for any pending obligations set forth in the settlement agreements relating to the CPAs and for complying with future awards eventually rendered in the remaining CPAs.

#### **Civil public action commenced by Associations concerning the use of Tanfloc for water treatment (R\$120 billion Associations claim)**

On 28 October 2021, the Vila Lenira Residents Association, State of Espírito Santo Rural Producers and Artisans Association, Colatina Velha Neighbourhood Residents Association, and United for the Progress of Palmeiras Neighbourhood Association filed a lawsuit against Samarco, BHP Brasil and Vale and others, including the State of Minas Gerais, the State of Espírito Santo and the Federal Government. The plaintiffs allege the defendants carried out a clandestine study on the citizens of the locations affected by the Samarco dam failure, using Tanfloc, a tannin-based flocculant/coagulant that is currently used for wastewater treatment applications. The plaintiffs claim this product allegedly put the population at risk due to its alleged experimental qualities.

On 17 November 2023, the Federal Court dismissed the lawsuit without prejudice due to the Associations' lack of standing to sue and the defectiveness of the complaint. The Associations filed a motion for clarification and the decision is still subject to appeal.

#### **Indigenous Communities – Civil public action for partial nullity of agreements**

In February 2024, the Federal Prosecutor's Office filed a collective lawsuit against the Companies, alleging that the settlement agreements entered into between Renova Foundation and the Indigenous communities of Tupiniquim Guarani, Mboapy Pindó, and Comboios contain nullities regarding the release of monthly Emergency Subsistence Aid (ASE), and requested an injunction ordering the Companies to continue to pay ASE to the Indigenous Peoples of the Tupiniquim, Comboios, and Caieiras Velha II, in the Indigenous Lands of Aracruz, State of Espírito Santo in Brazil, following certain new rules, including an increase in the monthly payment amount. On 4 March 2024, the Federal Court granted the Federal Prosecutor's request for a preliminary injunction, which was later overturned in April 2024. As of 30 June 2024, a final decision on the merits is pending.

## Other civil proceedings in Brazil

As noted above, BHP Brasil has been named as a defendant in numerous lawsuits relating to the Samarco dam failure. In addition, government inquiries and investigations relating to the Samarco dam failure have been commenced by the Brazilian Government's representatives and are ongoing, including studies regarding impact of the dam failure.

BHP Brasil's potential liabilities, if any, resulting from other pending and future claims, lawsuits and enforcement actions relating to the Samarco dam failure, together with the potential cost of implementing remedies sought in the various proceedings, cannot be reliably estimated at this time. Ultimately, these could have a material adverse impact on BHP's business, competitive position, cash flows, prospects, liquidity and shareholder returns.

## For more information on the Samarco dam failure refer to OFR 7

As of 30 June 2024, Samarco had been named as a defendant in more than 87,200 small claims for moral damages in which people argue their public water service was interrupted for between five and 10 days, of which approximately 38,000 claims are still active. BHP Brasil is a co-defendant in more than 24,300 of these cases.

The Brazilian Code of Civil Procedure provides that repetitive claims can be settled through a proceeding known as the Resolution of Repetitive Demands Procedure (IRDR). Under the IRDR, a court will hear a 'pilot case' representative of such recurring legal matters and the judgment in that decision will set a precedent for the resolution of similar cases in that jurisdiction. An IRDR has been established in Minas Gerais and the court in the pilot case has ruled that the mandatory parameter for resolution of claims will be the payment of R\$2,000 (approximately US\$400<sup>1</sup>) per individual claim for moral damages due to the suspension of public water supply. Appeals before higher courts were filed. Meanwhile, as of 30 June 2024, Samarco has reached settlement in more than 18,200 individual cases. On 21 May 2024, the Superior Court of Justice granted the State Prosecutor of Minas Gerais request to declare null the IRDR due to the alleged failure to satisfy the procedural requirements necessary for its formal admissibility.

## Samarco's judicial reorganisation

On 9 April 2021, Samarco filed for judicial reorganisation (JR) with the Second Business State Court for the Belo Horizonte District of Minas Gerais (JR Court). On 28 July 2023, Samarco and one of its supporting creditors filed a consensual plan (Consensual Plan), which provided, among other things, that the agreements entered into between Samarco and Brazilian public authorities in connection with the Samarco dam failure will not be impaired by the Consensual Plan and Samarco will continue to have the primary obligation to fund Renova Foundation. In addition, pursuant to the Consensual Plan, between 2024 and full payment of the debt owed by Samarco to the holders of the senior notes, Samarco is permitted to fund remediation activities to Renova Foundation up to a US\$1 billion cap. This means that BHP Brasil and Vale will pay directly or fund Samarco in the form of common equity in respect of remediation obligations, including payments to Renova Foundation, in excess of the US\$1 billion cap. The JR Court confirmed the Consensual Plan on 1 September 2023. Following the confirmation of the Consensual Plan and satisfaction of other conditions precedent set forth therein, the definitive documentation formalising the consummation of Samarco's financial debt restructuring was executed on 1 December 2023. Samarco has paid the majority of labour claims, suppliers and other non-financial creditors as provided in the Consensual Plan. BHP Brasil participated in Samarco's JR proceeding in its capacities as a shareholder and creditor of Samarco.

## Class or group action claims

BHP Group Limited and certain of its subsidiaries have been named as defendants in class or group action claims related to the Samarco dam failure. The most significant of those claims are summarised in the bullets below.

- BHP Group Limited is named as a defendant in a shareholder class action in the Federal Court of Australia on behalf of persons who acquired shares in BHP Group Limited or BHP Group Plc (now BHP Group (UK) Ltd) in periods prior to the Samarco dam failure. The amount of damages sought in the class action is unspecified. A trial is scheduled to commence in September 2025.
- BHP Group (UK) Ltd (formerly BHP Group Plc) and BHP Group Limited are named as defendants in group action claims for damages filed in the courts of England. These claims were filed on behalf of certain individuals, municipalities, businesses and communities in Brazil allegedly impacted by the Samarco dam failure. The amount of damages sought in these claims is unspecified. In December 2022, the BHP parties filed their defence and a contribution claim against Vale. The contribution claim contended that if the BHP parties' defence is not successful and they are ordered to pay damages to the claimants, Vale should contribute to any amount payable. A trial in relation to the BHP parties' liability for the dam failure is set to commence in October 2024.
- In January 2024, the BHP parties were served with a new group action filed in the courts of England on behalf of additional individuals and businesses in Brazil allegedly impacted by the Samarco dam failure. The new action makes broadly the same claims as the original action and the amount of damages sought in these claims is unspecified.

In March 2024, a claim was filed in the Netherlands against Vale S.A. and a Dutch subsidiary of Samarco for compensation relating to the Fundão dam failure. The claim filed in the Netherlands indicates that these claims were filed on behalf of certain individuals, municipalities, businesses, associations, and faith-based institutions allegedly impacted by the Samarco dam failure who are not also claimants in the UK group action claims referred to above. BHP is not a defendant in the Netherlands proceedings.

In July 2024, BHP Group Limited, BHP Group (UK) Ltd, BHP Brasil Ltda and Vale S.A. entered into an agreement – without any admission of liability in any proceedings – whereby: (i) Vale will pay 50 per cent of any amounts that may be payable by the BHP Defendants to the claimants in the UK group action claims (or by the BHP Defendants, BHP Brasil or their related parties to claimants in any other proceedings in Brazil, England or the Netherlands covered by the agreement); and (ii) BHP Brasil will pay 50 per cent of any amounts that may be payable by Vale to the claimants in the Netherlands proceedings (or by Vale or its related parties to claimants in any other proceedings in Brazil, England or the Netherlands covered by the agreement). The agreement reinforces the terms of the Framework Agreement entered into in 2016 which require BHP Brasil and Vale to each contribute 50 per cent to the funding of the Renova Foundation for compensation of persons impacted by the Fundão dam failure where Samarco is unable to contribute that funding. The BHP Defendants withdrew the contribution claim against Vale in England as it is no longer necessary given this agreement.

## **Criminal charges**

On 20 October 2016, the Federal Prosecutors' Office in Brazil filed criminal charges against Samarco, BHP Brasil, Vale and certain of their employees and former employees in the Federal Court of Ponte Nova, Minas Gerais. On 3 March 2017, BHP Brasil and the charged employees and former employees of BHP Brasil (Affected Individuals) filed their preliminary defences. The Federal Court granted Habeas Corpus petitions in favour of all eight Affected Individuals, terminating the charges against those individuals. The Federal Prosecutors' Office appealed seven of the decisions with hearings of the appeals still pending. BHP Brasil remains a defendant in the criminal proceeding. The evidentiary phase has been concluded and Federal Prosecutors and defendants are expected to present written closing arguments by August 2024. BHP Brasil rejects the charges against BHP Brasil and the Affected Individuals and expects to defend against the charges and fully support each of the Affected Individuals in their defences of the charges.

In several civil proceedings the Federal Court has stated that Renova Foundation has allegedly obstructed the adoption of reparation measures. The judge ordered an official notice to be sent to the Prosecutor's Office to communicate his view on the need for an investigation into Renova Foundation's conduct. On 10 May 2024 the Public Prosecutor's Office publicly announced that they will conduct an investigation into Renova Foundation, without specifying if civil or criminal liability for Renova Foundation, BHP Brasil, Vale, Samarco or any individual will be sought.

## **Legal proceedings unrelated to the Samarco dam failure**

### **South African class action claim**

On 14 August 2023, an application to commence a class action was filed in the High Court of South Africa on behalf of current and former mineworkers (and the dependants of certain mineworkers). The mineworkers are alleged to have contracted coal mine dust lung disease and to have worked on specified coal mines in South Africa between 1965 and the filing date. 'BHP Billiton Plc Incorporated' is named as a respondent, alongside South32 SA Holdings Limited and Seriti Power (Proprietary) Limited. The claims against the BHP entity relate to the period from 1999 to 2015. The relevant businesses were divested in 2015 as part of the demerger of South32 Limited.

The matter is currently at the certification stage whereby the South African Court must first grant permission for a class action to proceed. BHP, South32 and Seriti have filed notices opposing certification. The amount of damages sought by the Applicants on behalf of the putative class is unspecified. BHP has notified South32 that it considers any liability to the Applicants arising from the class action to be indemnified under the terms of the Separation Deed agreed as part of the demerger of South32 in 2015.

## **9 Shareholder information**

### **9.1 History and development**

BHP Group Limited (formerly BHP Billiton Limited, before then BHP Limited and, before that, The Broken Hill Proprietary Company Limited) was incorporated in 1885 and is registered in Australia with ABN 49 004 028 077.

### **9.2 Markets**

As at the date of this Annual Report, BHP Group Limited has a primary listing on the Australian Securities Exchange (ASX) (ticker BHP) in Australia, an international secondary listing on the London Stock Exchange (LSE) (ticker BHP), a secondary listing on the Johannesburg Stock Exchange (ticker BHG) and is listed on the New York Stock Exchange (NYSE) in the United States.

Trading on the NYSE is in the form of American Depositary Receipts (ADRs) evidencing American Depositary Shares (ADSs), with each ADS representing two ordinary shares of BHP Group Limited. Citibank N.A. (Citibank) is the Depositary for the ADS program. BHP Group Limited's ADSs have been listed for trading on the NYSE (ticker BHP) since 28 May 1987.

### 9.3 Organisational structure

BHP Group Limited is the ultimate parent company of all subsidiaries within the BHP Group.

From June 2001 to January 2022, BHP operated under a Dual Listed Company (DLC) structure, with two separate parent companies (BHP Group Limited and BHP Group Plc (now BHP Group (UK) Limited) and their respective subsidiaries operating as a single unified economic entity run by a unified Board and senior executive management team.

On 31 January 2022, BHP unified its DLC structure, following which BHP Group Plc (now BHP Group (UK) Limited) became a subsidiary of BHP Group Limited.

### 9.4 Constitution

This section sets out a summary of BHP Group Limited's Constitution, as well as other related arrangements under applicable laws and regulations.

Provisions of the Constitution of BHP Group Limited can be amended only where such amendment is approved by special resolution. A special resolution is a resolution that is passed by at least 75 per cent (i.e. at least three quarters) of the votes cast by BHP shareholders entitled to vote being in favour of the resolution.

#### Board

The Board may exercise all powers of BHP, other than those that are reserved for BHP shareholders to exercise in a general meeting.

#### Power to issue securities

Under the Constitution, the Board has the power to issue any BHP shares or other securities (including redeemable shares) with preferred, deferred or other special rights, obligations or restrictions. The Board may issue shares on any terms it considers appropriate, provided that:

- the issue does not affect any special rights of shareholders
- if required, the issue is approved by shareholders
- if the issue is of a class other than ordinary shares, the rights attaching to the class are expressed at the date of issue

#### Restrictions on voting by Directors

A Director may not vote in respect of any contract or arrangement or any other proposal in which they have a material personal interest except in certain prescribed circumstances, including (subject to applicable laws) where the material personal interest:

- arises because the Director is a shareholder of BHP and is held in common with the other shareholders of BHP
- arises in relation to the Director's remuneration as a Director of BHP
- relates to a contract BHP is proposing to enter into that is subject to approval by the shareholders and will not impose any obligation on BHP if it is not approved by the shareholders
- arises merely because the Director is a guarantor or has given an indemnity or security for all or part of a loan, or proposed loan, to BHP
- arises merely because the Director has a right of subrogation in relation to a guarantee or indemnity referred to above
- relates to a contract that insures or would insure the Director against liabilities the Director incurs as an officer of BHP, but only if the contract does not make BHP or a related body corporate the insurer
- relates to any payment by BHP or a related body corporate in respect of an indemnity permitted by law, or any contract relating to or containing such an indemnity, or
- is in a contract or proposed contract with or for the benefit of or on behalf of a related body corporate and arises merely because the Director is a director of a related body corporate

If a Director has a material personal interest and is not entitled to vote on a proposal, they will not be counted in the quorum for any vote on a resolution concerning the material personal interest.

#### Loans by Directors

Any Director may lend money to BHP at interest with or without security or may, for a commission or profit, guarantee the repayment of any money borrowed by BHP and underwrite or guarantee the subscription of shares or securities of BHP or of any corporation in which BHP may be interested without being disqualified as a Director and without being liable to account to BHP for any commission or profit.

## **Appointment and retirement of Directors**

### **Appointment of Directors**

The Constitution provides that a person may be appointed as a Director of BHP Group Limited by the existing Directors of BHP or may be elected by the shareholders in a general meeting.

Any person appointed as a Director of BHP Group Limited by the existing Directors will hold office only until the next general meeting that includes an election of Directors.

A person may be nominated by shareholders as a Director of BHP Group Limited if:

- a shareholder provides a valid written and signed notice of the nomination
- the person nominated by the shareholder satisfies candidature for the office and provides written and signed notice of their willingness to be elected as a Director

and the nomination is provided at least 40 business days before the date of the general meeting. The person nominated as a Director may be elected to the Board by ordinary resolution passed in a general meeting.

### **Retirement of Directors**

The Board has adopted a policy under which all Non-executive Directors must, if they wish to remain on the Board, seek re-election by shareholders annually. This policy took effect in 2011 and replaced the previous system that required Non-executive Directors to submit themselves to shareholders for re-election at least every three years.

A Director may be removed from the Board in accordance with applicable law and must vacate their office as a Director in certain circumstances set out in the Constitution. There is no requirement for a Director to retire on reaching a certain age.

## **Rights attaching to shares**

### **Dividend rights**

Under Australian law, dividends on shares may be paid only if the company's assets exceed its liabilities immediately before the dividend is determined and the excess is sufficient for payment of the dividend, the payment of the dividend is fair and reasonable to the company's shareholders as a whole and the payment of the dividend does not materially prejudice the company's ability to pay its creditors.

The Constitution provides that payment of any dividend may be made in any manner, by any means and in any currency determined by the Board.

All unclaimed dividends may be invested or otherwise used by the Board for the benefit of BHP until claimed or otherwise disposed of according to law. BHP Group Limited is governed by the Victorian unclaimed monies legislation, which requires BHP to pay to the State Revenue Office any unclaimed dividend payments of A\$20 or more that have remained unclaimed for over 12 months.

### **Voting rights**

For the purposes of determining which shareholders are entitled to attend or vote at a meeting of BHP Group Limited and how many votes such shareholder may cast, the Notice of Meeting specifies when a shareholder must be entered on the Register of Shareholders in order to have the right to attend or vote at the meeting. The specified time must be not more than 48 hours before the time of the meeting.

Shareholders who wish to appoint a proxy to attend, vote or speak at a meeting of BHP Group Limited on their behalf must deposit the form appointing a proxy so that it is received not less than 48 hours before the time of the meeting.

### **Rights to share in profits**

The rights attached to shares of BHP Group Limited, as regards the participation in the profits available for distribution that the Board determines to distribute, are as follows:

- The holders of any preference shares will be entitled, in priority to any payment of dividend to the holders of any other class of shares, to a preferred right to participate as regards dividends up to but not beyond a specified amount in distribution.
- Any surplus remaining after payment of the distributions above will be payable to the holders of ordinary shares in equal amounts per share.

### **Rights on return of assets on liquidation**

On a return of assets on liquidation of BHP Group Limited, the assets of BHP Group Limited remaining available for distribution among shareholders after the payment of all prior ranking amounts owed to all creditors and holders of preference shares, and to all prior ranking statutory entitlements, are to be applied on an equal priority with any amount paid to the holders of BHP Group Limited ordinary shares. Any surplus remaining is to be applied in making payments solely to the holders of BHP Group Limited ordinary shares in accordance with their entitlements.

## Redemption of preference shares

If BHP Group Limited at any time proposes to create and issue any preference shares, the terms of the preference shares may give either or both of BHP Group Limited and the holder the right to redeem the preference shares.

The preference shares' terms may also give the holder the right to convert the preference shares into ordinary shares.

Under the Constitution, the preference shares must give the holders:

- the right (on redemption and on a winding-up) to payment in cash in priority to any other class of shares of (i) the amount paid or agreed to be considered as paid on each of the preference shares; and (ii) the amount, if any, equal to the aggregate of any dividends accrued but unpaid and of any arrears of dividends
- the right, in priority to any payment of dividend on any other class of shares, to the preferential dividend

## Capital calls

Subject to the terms on which any shares may have been issued, the Board may make calls on the shareholders in respect of all monies unpaid on their shares. BHP Group Limited has a lien on every partly paid share for all amounts payable in respect of that share. Each shareholder is liable to pay the amount of each call in the manner, at the time and at the place specified by the Board (subject to receiving at least 14 days' notice specifying the time and place for payment). A call is considered to have been made at the time when the resolution of the Board authorising the call was passed.

## Borrowing powers

Subject to relevant law, the Directors may exercise all powers of BHP to borrow money and to mortgage or charge its undertaking, property, assets (both present and future) and all uncalled capital or any part or parts thereof, and to issue debentures and other securities, whether outright or as collateral security for any debt, liability or obligation of BHP or of any third party.

## Variation of class rights

Rights attached to any class of shares issued by BHP Group Limited can only be varied where such variation is approved by:

- the company as a special resolution, and
- the holders of the issued shares of the affected class, either by a special resolution passed at a separate meeting of the holders of the issued shares of the class affected, or with the written consent of members with at least 75 per cent of the votes of that class

## Annual General Meetings

The Annual General Meeting (AGM) provides a forum to facilitate the sharing of shareholder views and is an important event in the BHP calendar. The meeting provides an update for shareholders on our performance and offers an opportunity for shareholders to ask questions and vote. To vote at an AGM, a shareholder must be a registered holder of BHP Group Limited shares at a designated time before the relevant AGM.

Key members of management, including the Chief Executive Officer (CEO) and Chief Financial Officer, are present and available to answer questions. The External Auditor will also be available to answer questions.

Proceedings at AGMs are webcast live from our website. Copies of the speeches delivered by the Chair and CEO to the AGM are released to the relevant stock exchanges and posted on our website. The outcome of voting on the items of business are released to the relevant stock exchanges and posted on our website as soon as they are available following completion of the AGM and finalisation of the polls.

**More information on our AGMs is available at [bhp.com/meetings](http://bhp.com/meetings)**

## Conditions governing general meetings

The Board may, and must on requisition in accordance with applicable laws, call a general meeting of the shareholders at the time and place or places and in the manner determined by the Board. No shareholder may convene a general meeting of BHP Group Limited except where entitled under law to do so. Any Director may convene a general meeting whenever the Director thinks fit. General meetings can also be adjourned, cancelled or postponed where permitted by law or the Constitution. Notice of a general meeting must be given to each shareholder entitled to vote at the meeting and such notice of meeting may be given in the form and manner in which the Board thinks fit subject to any applicable law. Five shareholders of the company present in person or by proxy constitute a quorum for a general meeting. A shareholder who is entitled to attend and cast a vote at a general meeting of BHP Group Limited may appoint a person as a proxy to attend and vote for the shareholder in accordance with applicable law. All provisions of the Constitution relating to general meetings apply with any necessary modifications to any special meeting of any class of shareholders that may be held.

## Limitations of rights to own securities

There are no limitations under the Constitution restricting the right to own BHP shares or other securities. The Australian Foreign Acquisitions and Takeovers Act 1975 imposes a number of conditions that restrict foreign ownership of Australian-based companies.

## For information on share control limits imposed by relevant laws refer to Additional information 9.8

### Documents on display

Documents filed by BHP Group Limited on the Australian Securities Exchange (ASX) are available at [asx.com.au](http://asx.com.au) and documents filed on the London Stock Exchange (LSE) are available at [data.fca.org.uk/#/nsm/nationalstoragemechanism](http://data.fca.org.uk/#/nsm/nationalstoragemechanism). Documents filed on the ASX or on the LSE are not incorporated by reference into this Annual Report. The documents referred to in this Annual Report as being available on our website, [bhp.com](http://bhp.com), are not incorporated by reference and do not form part of this Annual Report.

**BHP Group Limited files Annual Reports and other reports and information with the US Securities and Exchange Commission (SEC). These filings are available on the SEC website at [sec.gov](http://sec.gov)**

## 9.5 Share ownership

### Share capital

The details of the share capital for BHP Group Limited are presented in Financial Statements note 17 'Share capital' and remain current as at 16 July 2024.

### Substantial shareholders in BHP Group Limited

BHP Group Limited is not directly or indirectly controlled by another corporation or by any government. No shareholder possesses voting rights that differ from those attaching to all of BHP Group Limited's voting securities.

The following table shows holdings of 5 per cent or more of voting rights in BHP Group Limited's shares as notified to BHP Group Limited under the Australian Corporations Act 2001 (Cth), Section 671B as at 16 July 2024.

Title of class	Identity of person or group	Date of last notice		Number owned	% of total voting rights <sup>1</sup>
		Date received	Date of change		
Ordinary shares	BlackRock Group <sup>2</sup>	03 February 2022	31 January 2022	347,008,470	6.85%
Ordinary shares	Citigroup Global Markets Australia Pty Limited	26 April 2022	21 April 2022	318,921,856.17	6.2999%
Ordinary shares	State Street Corporation	15 May 2024	13 May 2024	310,604,627	6.12%
Ordinary shares	The Vanguard Group Inc.	13 September 2022	07 September 2022	253,318,530	5.001%

<sup>1</sup> The percentages quoted are based on the voting rights provided in the last substantial shareholders' notice.

<sup>2</sup> In addition, on 3 February 2022, BlackRock Group notified that, as of 31 January 2022, it owned 4,152,969 American Depositary Receipts, with a voting power of 0.08 per cent. Each American Depositary Receipt represents two fully paid ordinary shares in BHP Group Limited.



Twenty largest shareholders as at 16 July 2024 (as named on the Register of Shareholders)<sup>1</sup>

<b>BHP Group Limited</b>		<b>Number of fully paid shares</b>	<b>% of issued capital</b>
1.	HSBC Custody Nominees (Australia) Limited <sup>2</sup>	1,385,528,644	27.32
2.	J P Morgan Nominees Australia Pty Limited	909,805,343	17.94
3.	Citicorp Nominees Pty Ltd	379,203,501	7.48
4.	Citicorp Nominees Pty Limited <Citibank NY ADR DEP A/C>	289,613,351	5.71
5.	Computershare Clearing Pty Ltd <CCNL DI A/C> <sup>3</sup>	230,277,141	4.54
6.	South Africa Control A/C\C <sup>4</sup>	186,947,112	3.69
7.	BNP Paribas Nominees Pty Ltd <Agency Lending A/C>	104,509,093	2.06
8.	National Nominees Limited	75,964,078	1.50
9.	BNP Paribas Noms Pty Ltd	68,456,596	1.35
10.	Citicorp Nominees Pty Limited <Colonial First State Inv A/C>	45,222,045	0.89
11.	HSBC Custody Nominees (Australia) Limited <Nt-Commwlt Super Corp A/C>	36,674,802	0.72
12.	BNP Paribas Nominees Pty Ltd <Clearstream>	24,925,705	0.49
13.	Computershare Nominees CI Ltd <ASX Shareplus Control A/C>	22,796,591	0.45
14.	BNP Paribas Nominees Pty Ltd <HUB24 Custodial Serv Ltd>	18,864,475	0.37
15.	Netwealth Investments Limited <Wrap Services A/C>	15,707,723	0.31
16.	Australian Foundation Investment Company Limited	13,413,159	0.26
17.	HSBC Custody Nominees (Australia) Limited	12,593,578	0.25
18.	Argo Investments Limited	9,990,464	0.20
19.	BNP Paribas Noms (NZ) Ltd	5,759,220	0.11
20.	HSBC Custody Nominees (Australia) Limited <Euroclear Bank SA NV A/C>	5,574,343	0.11
		<b>3,841,826,964</b>	<b>75.75</b>

1. Many of the 20 largest shareholders shown for BHP Group Limited hold shares as a nominee or custodian. In accordance with the reporting requirements, the tables reflect the legal ownership of shares and not the details of the underlying beneficial holders.

2. HSBC Custody Nominees (Australia) Limited is listed twice in the above table as they are registered separately under the same name on the share register.

3. Computershare Clearing Pty Ltd <CCNL DI A/C> represents the Depository Interest Register (UK).

4. South Africa Control A/C\C represents the South African branch register.

## US share ownership as at 16 July 2024

	BHP Group Limited			
	Number of shareholders	%	Number of fully paid shares	% of issued capital
<b>Classification of holder</b>				
Registered holders of voting securities	1,737	0.28	4,354,308	0.09
ADR holders	1,851	0.30	289,590,736 <sup>1</sup>	5.71

<sup>1</sup> The number of shares corresponds to 144,795,368 ADRs.

## Distribution of shareholdings by size as at 16 July 2024

Size of holding	BHP Group Limited			
	Number of shareholders	%	Number of shares <sup>1</sup>	%
1 – 500 <sup>2</sup>	299,724	48.57	58,313,947	1.15
501 – 1,000	107,646	17.44	82,278,812	1.62
1,001 – 5,000	165,585	26.83	372,175,995	7.34
5,001 – 10,000	26,637	4.32	187,925,361	3.71
10,001 – 25,000	13,366	2.17	200,493,124	3.95
25,001 – 50,000	2,787	0.45	95,487,981	1.88
50,001 – 100,000	912	0.15	62,785,184	1.24
100,001 – 250,000	312	0.05	44,593,549	0.88
250,001 – 500,000	73	0.01	23,970,370	0.47
500,001 – and over	73	0.01	3,943,506,494	77.76
<b>Total</b>	<b>617,115</b>	<b>100</b>	<b>5,071,530,817</b>	<b>100</b>

1. One ordinary share entitles the holder to one vote.

2. The number of BHP Group Limited shareholders holding less than a marketable parcel (A\$500) based on the market price of A\$43.08 as at 16 July 2024 was 7,576.

## 9.6 Dividends

### Policy

The Group adopted a dividend policy in February 2016 that provides for a minimum 50 per cent payout of Underlying attributable profit (Continuing operations) at every reporting period.

**For information on Underlying attributable profit (Continuing operations) for FY2024 refer to OFR 4.2 and OFR 10**

The Board will assess, at each reporting period, the ability to pay amounts additional to the minimum payment, in accordance with the Capital Allocation Framework, as described in OFR 2.

In FY2024, we determined our dividends and other distributions in US dollars as it is our main functional currency.

### Payments

BHP Group Limited shareholders may have their cash dividends paid directly into their bank account in Australian dollars, UK pounds sterling, New Zealand dollars, South African rand or US dollars, provided they have submitted direct credit details and if required, a valid currency election nominating a financial institution to the BHP Share Registrar no later than close of business on the dividend reinvestment plan election date. BHP Group Limited shareholders who do not provide their direct credit details will receive dividend payments by way of a cheque in Australian dollars. BHP Group Limited shareholders who reside in New Zealand must provide valid direct credit details to receive their dividend payment.

### Dividend reinvestment plan

BHP offers a dividend reinvestment plan to registered shareholders, which provides shareholders the opportunity to reinvest dividends to purchase additional BHP shares in the market, rather than receiving dividends in cash. Participation in the plan is entirely optional and is subject to the terms and conditions of the plan, which can be found at [bhp.com/DRP](http://bhp.com/DRP).

## 9.7 American Depositary Receipts fees and charges

We have an American Depositary Receipts (ADR) program for BHP Group Limited which has a 2:1 ordinary shares to American Depositary Share (ADS) ratio.

### Depository fees

Citibank serves as the depository bank for our ADR program. ADR holders agree to the terms in the deposit agreement filed with the SEC for depositing ordinary shares or surrendering ADSs for cancellation and for certain services as provided by Citibank. Holders are required to pay certain fees for general depository services provided by Citibank, as set out in the tables below.

#### Standard depository fees

##### Depository service

Depository service	Fee payable by the ADR holders
Issuance of ADSs upon deposit of shares	Up to US\$5.00 per 100 ADSs (or fraction thereof) issued
Delivery of Deposited Securities against surrender of ADSs	Up to US\$5.00 per 100 ADSs (or fraction thereof) surrendered
Distribution of Cash Dividends	Up to US\$1.50 per 100 ADSs (or fraction thereof) held

#### Corporate actions depository fees

##### Depository service

Depository service	Fee payable by the ADR holders
Cash Distributions other than Cash Dividends (i.e. sale of rights, other entitlements, return of capital)	Up to US\$2.00 per 100 ADSs (or fraction thereof) held
Distribution of ADSs pursuant to exercise of rights to purchase additional ADSs. Excludes stock dividends and stock splits	Up to US\$5.00 per 100 ADSs (or fraction thereof) held
Distribution of securities other than ADSs or rights to purchase additional ADSs (i.e., spin-off shares)	Up to US\$5.00 per 100 ADSs (or fraction thereof) held
Distribution of ADSs pursuant to an ADR ratio change in which shares are distributed	No fee

### **Fees payable by the Depositary to the Issuer**

Citibank has provided a BHP net reimbursement of US\$2,512,358.75 in FY2024 for ADR program-related expenses for BHP's ADR program. ADR program-related expenses include legal and accounting fees, listing fees, expenses related to investor relations in the United States, fees payable to service providers for the distribution of material to ADR holders, expenses of Citibank as administrator of the ADS Direct Plan and expenses to remain in compliance with applicable laws.

Citibank has further agreed to waive other ADR program-related expenses for FY2024, amounting to US\$5,812.12, which are associated with the administration of the ADR program.

The ADSs issued under our ADR program trade on the NYSE under the stock ticker BHP. As of 16 July 2024, there were 144,795,368 ADSs on issue and outstanding in the BHP Group Limited ADR program.

### **Charges**

Holders are also required to pay the following charges in connection with depositing of ordinary shares and surrendering ADSs for cancellation and for the purpose of withdrawing deposited securities: taxes and other governmental charges, registration fees, transmission and delivery expenses, expenses and charges incurred by the depositary in the conversion of foreign currency, fees and expenses of the depositary in connection with compliance with exchange control regulations and other regulatory requirements and fees and expenses incurred by the depositary or other nominee in connection with servicing or delivery of deposit securities.

## **9.8 Supplemental cybersecurity disclosures for US reporting**

Our approach to managing material risks from cyber threats is integrated into our overall risk management processes. Cybersecurity risks are addressed by BHP's Risk Framework, a system of control for identifying and managing risks, implemented by the CEO.

### **For information on our Risk Framework refer to OFR 8**

We employ a number of measures designed to protect against, detect and respond to cyber threats, events or attacks, including BHP's mandatory minimum performance requirements for technology and cybersecurity, cybersecurity performance requirements for suppliers and cybersecurity resilience programs. In addition, cybersecurity standards, cybersecurity risk and control guidance, security awareness programs and training to build capability, security assessments and continuous monitoring, restricted physical access to hardware and crisis management plans are also in place to manage cybersecurity.

We utilise dedicated internal and external cybersecurity personnel to focus on assessing, detecting, identifying, managing, preventing and responding to cyber threats, events and attacks. We have a dedicated cybersecurity team, which has been in place since 2016 and has 24/7 monitoring and response capability that leverages core in-house capability and external service providers. Our assets, functions and projects are responsible for managing localised or project-specific exposure to technology and cyber risks, including risks associated with business-critical technology systems, with guidance provided by our cybersecurity team. Enterprise-level risks that are specific to technology, such as those that pose a greater threat to our wider business and strategic opportunities, are managed by our global Technology team and other relevant stakeholders.

We regularly evaluate and assess the threat landscape and our security controls, including through audits and assessments, regular network and endpoint monitoring, vulnerability testing, penetration testing and tabletop exercises that include members of BHP's management team. To assess the design and effectiveness of our cybersecurity controls, we engage with assessors, consultants, auditors or other third parties, including through independent third-party reviews of our information technology security program conducted on a periodic basis. We have processes in place to consider and remediate any findings from these reviews and assessments as required. We also have processes to oversee and identify material cybersecurity risks associated with our use of third-party service providers, including performing diligence on certain third parties that have access to our systems, data or facilities that store such systems or data and we continually monitor cybersecurity risks identified through such diligence. We also utilise contractual clauses to manage cybersecurity risks, including by requiring certain agreements to be subject to periodic cybersecurity audits.

We have experienced targeted and non-targeted cybersecurity threats in the past; however, no prior cybersecurity incident has materially affected our business strategy, results of operations or financial condition.

### **For information on our risk factors refer to OFR 8.1**

### **Governance**

The Board, supported by the Risk and Audit Committee (RAC), is responsible for oversight of emerging and principal risks facing the Group. The Board and the RAC receive updates on the Group's cybersecurity position, and the Group has policies in place through the Group's disclosure process that are designed to escalate material incidents.

**For information on other Board Committee activities that support risk governance at BHP refer to the above ‘Risk governance’ disclosures and the Corporate Governance Statement 5**

The CEO is responsible for the effectiveness of BHP’s Risk Framework with oversight from the Board. Primary responsibility for Technology and Systems Group Risk (which includes the cybersecurity risks), rests with the Chief Technical Officer under authority delegated by the CEO.

The Chief Technical Officer is accountable for and establishes the risk appetite for Technology and Systems, while the Vice President (VP) Technology Secure & Architecture is responsible for overseeing the performance of cybersecurity risks in the Technology and Systems Group Risk category within that risk appetite, and provides reports concerning these matters to the Chief Technical Officer.

Our VP Technology Secure & Architecture oversees the prevention, detection, mitigation and remediation of cybersecurity incidents through their management of, and participation in, our cybersecurity risk management and cybersecurity strategy processes described above.

Our VP Technology Secure & Architecture leads the BHP cybersecurity team involved in monitoring and managing our cyber security threat risk and assurance process. That team includes personnel with significant information technology experience. During FY2024, two individuals held the role of VP Technology Secure & Architecture, each of whom has more than 25 years of experience in the information technology and information security field, including serving as chief information security officer (CISO) and deputy CISO at other large companies. Our current VP Technology Secure & Architecture holds a number of qualified technical expert certifications, including Certified Information Systems Security Professional (CISSP) since 2001 and various cybersecurity-related technical certifications, in addition to Master in Information Technology (specialising in Information Security) and Master in Business Administration degrees, and is active in various cybersecurity industry collaboration groups internationally.

## **9.9 Government regulations**

Our business is subject to a broad range of laws and regulations imposed by governments and regulatory bodies. These laws and regulations touch all aspects of our business, including how we extract, process and explore for minerals and how we conduct our operations, including laws and regulations governing matters such as environmental protection, land rehabilitation, occupational health and safety, human rights, cultural heritage, the rights and interests of Indigenous peoples, competition, foreign investment, export, marketing of minerals, and taxes.

The ability to extract and process minerals is fundamental to BHP. In most jurisdictions, the rights to extract mineral deposits are owned by the government. We obtain the right to access the land and extract the product by entering into licences or leases with the government that owns the mineral deposit. We also rely on governments to grant the rights necessary to transport and treat the extracted material to prepare it for sale. The terms of the lease or licence, including the time period of the lease or licence, vary depending on the laws and regulations of the relevant jurisdiction or terms negotiated with the relevant government.

Generally, we own the product we extract and we are required to pay royalties or other taxes to the government. In Australia and Chile, recent reforms to mining royalties laws have been adopted. For example, from 1 July 2022, a progressive system of coal royalties in the State of Queensland was adopted, resulting in higher royalty rates as the price of coal passes certain monetary thresholds. In May 2024, the Queensland Government introduced new legislation to Parliament which, if passed, would prevent future governments from reversing these higher royalty rates without parliamentary approval. Similarly, in September 2023, the State of New South Wales introduced a new coal royalty scheme, replacing the emergency domestic coal cap and reservation measures. This increase took effect on 1 July 2024, increasing the royalty rate payable for different methods of extraction by 2.6 percentage points. In May 2023, the Chilean Congress approved a mining royalty bill to establish a new regulatory tax framework for copper mining activities, which, in general terms, established that mining operators are subject to an ad-valorem component plus a margin component, with a maximum tax rate of 46.5 per cent. The new Chilean mining royalties took effect from 1 January 2024, subject to existing tax stability agreements. In most instances, the rights to explore for minerals are granted to us by the government that owns the natural resources we wish to explore. Usually, the right to explore carries with it the obligation to spend a defined amount of money on the exploration, or to undertake particular exploration activities.

Environmental protection, mine closure, land rehabilitation, cultural heritage and occupational health and safety are principally regulated by governments and to a lesser degree, if applicable, by conditions under leases or licences. These obligations often require us to make substantial expenditures to minimise or remediate the environmental impact of our assets and to ensure the safety of our employees, contractors and the communities where we operate.

In many of the jurisdictions where we or our suppliers or customers operate, legislation and regulations are increasingly being enacted in response to the potential impacts of climate change and to implement international environmental commitments. For example, as a result of the Paris Agreement a number of governments, including Australia, Chile, Canada and the United States, have submitted Nationally Determined Contributions to reduce national greenhouse gas emissions (GHG). Further, the governments in a number of regions where we or our suppliers or customers operate have advanced targets and goals to reduce GHGs. In Australia, the National Greenhouse and Energy Reporting Act 2007 (Cth) imposes requirements for corporations meeting a certain threshold to register and report company information about GHGs and energy production and consumption as part of a single, national reporting scheme and establishes the Safeguard Mechanism to keep certain GHG emissions at or below legislated limits, known as baselines, for Australia’s largest industrial facilities. On 1 July 2023, amendments to the Safeguard Mechanism commenced operation, which require facility baselines for Scope 1 GHG emissions at Australia’s largest industrial facilities to be decreased in accordance with a set decline rate, with a view to achieving consistent and gradual emission reductions on a trajectory consistent with achieving Australia’s GHG emission reduction targets of 43 per cent below 2005 levels by 2030 and net zero by 2050. Facilities that exceed their progressively declining legislated baselines may apply credits to meet the compliance obligations.

Regulations setting emissions standards for fuels used to power vehicles and equipment at our assets and the modes of transport used in our supply chains can also have a substantial impact, both directly and indirectly, on the markets for these products, with flow-on impacts on our costs.

A number of governments and regulators in relevant jurisdictions for BHP have proposed or foreshadowed disclosure rules that would require enhanced climate-related and broader sustainability-related disclosures. For example, in Australia, the Federal Government has proposed legislation that would implement a new mandatory climate-related financial disclosure regime and associated auditing and assurance requirements, intended to be phased in from 1 January 2025. There is also growing focus on mandatory corporate due diligence and reporting for climate- and broader sustainability-related issues in the value chain. For example, the new European Union (EU) Corporate Sustainability Due Diligence Directive requires in-scope companies to conduct human rights and environmental due diligence on the company's own operations and their business partners' chain of activities (largely upstream). While it is not yet possible to reasonably estimate the exact nature, extent, timing and cost or other impacts of any future climate-related or broader sustainability-related regulatory programs or future legislative action that may be enacted, we anticipate we will be required to dedicate more resources to address legislative or regulatory changes.

In Australia, national environmental law is currently undergoing review with the potential for significant reform, including an emphasis on addressing environmental decline and achieving nature-positive outcomes, although timing, scope and outcome remain uncertain. Aspects of heritage protection laws in Australia have also been reviewed. For example, in November 2023, the Western Australian parliament repealed the Aboriginal Cultural Heritage Act 2021 (WA) and reverted to the previous Aboriginal Cultural Heritage Act 1972 (WA) (with limited amendments).

Our business is also subject to a number of regulations and legal developments relating to employee relations.

From time to time, certain trade sanctions are adopted by the United Nations (UN) Security Council and/or various governments, including in the United Kingdom, the United States, the European Union (EU), China and Australia against certain countries, entities or individuals, that may restrict our ability to sell extracted minerals or other products to and/or our ability to purchase goods or services from, these countries, entities or individuals.

### **Shareholding limits**

Under current Australian legislation, the payment of any dividends, interest or other payments by BHP Group Limited to non-resident holders of BHP Group Limited's shares is not restricted by exchange controls or other limitations, except that in certain circumstances, BHP Group Limited may be required to withhold Australian taxes.

From time to time, certain sanctions are adopted by the UN Security Council and/or various governments, including in the United Kingdom, the United States, the EU and Australia. Those sanctions prohibit, or in some cases impose, certain approval and reporting requirements on transactions involving sanctioned countries, entities and individuals and/or assets controlled or owned by them. Certain transfers into or out of Australia of amounts greater than A\$10,000 in any currency may also be subject to reporting requirements.

The Australian Foreign Acquisitions and Takeovers Act 1975 (the FATA) restricts certain acquisitions of interests in securities in Australian companies, including BHP Group Limited. Generally, under the FATA, the prior approval of the Australian Treasurer must be obtained for proposals by a foreign person (either alone or together with its associates) to acquire 20 per cent or more of the voting power or issued securities in an Australian company. Lower approval thresholds apply in certain circumstances, including for acquisitions of interests in entities that operate a 'national security business', and acquisitions of interests by foreign government investors of voting power or issued securities in an Australian company.

The FATA also empowers the Treasurer to make certain orders prohibiting acquisitions by foreign persons in Australian companies, including BHP Group Limited (and requiring divestiture if the acquisition has occurred) where the Treasurer considers the acquisition to be contrary to national security or the national interest.

Except for the restrictions under the FATA, there are no limitations, either under Australian law or under the Constitution of BHP Group Limited, on the right of non-residents to hold or vote BHP Group Limited ordinary shares.

### Post-unification requirements under FATA

The Treasurer gave approval under the FATA for the actions taken as part of implementation of the unification of BHP's DLC structure on the conditions set out below:

- BHP Group Limited remains an Australian resident company, incorporated under the Corporations Act, that is listed on the ASX under the name 'BHP Group Limited' and trades under that name.
- BHP Group Limited remains the ultimate holding company of and continues to ultimately manage and control the companies conducting the businesses that are presently conducted by the subsidiaries of BHP Group Limited, including the Minerals and Services businesses, for so long as those businesses form part of the BHP Group.
- The headquarters of BHP Group Limited (including the BHP Group's corporate head offices) are in Australia.
- The Chief Executive Officer of BHP Group Limited has their principal office in Australia.
- The centre of administrative and practical management of BHP Group Limited is in Australia and BHP Group Limited's corporate head office activities, of the kind presently carried on in Australia, continue to be managed in Australia.
- The headquarters of BHP Group Limited is publicly acknowledged as being in Australia in significant public announcements and in all public documents.
- The Chief Executive Officer of BHP Group Limited has their principal place of residence in Australia.
- The majority of all regularly scheduled Board meetings of BHP Group Limited in any calendar year occurs in Australia.

## 9.10 Taxation

The taxation discussion below describes the material Australian and US federal income tax consequences to a US holder owning BHP Group Limited ordinary shares or ADSs.

The following discussion is not relevant to non-US holders of BHP Group Limited ordinary shares or ADSs. By its nature, the commentary below is of a general nature and we recommend that holders of ordinary shares or ADSs consult their own tax advisers regarding the Australian and US federal, state and local tax and other tax consequences of owning and disposing of ordinary shares and ADSs in their particular circumstances.

For purposes of this commentary, a US holder is a beneficial owner of ordinary shares or ADSs who is, for US federal income tax purposes:

- a citizen or resident alien of the US;
- a corporation (or other entity treated as a corporation for US federal income tax purposes) that is created or organised under the laws of the US or any political subdivision thereof;
- an estate, the income of which is subject to US federal income taxation regardless of its source; or
- a trust:
  - (a) if a court within the US is able to exercise primary supervision over its administration and one or more US persons have the authority to control all of its substantial decisions; or
  - (b) that has made a valid election to be treated as a US person for tax purposes.

This discussion of material tax consequences for US holders is based on the Australian and US laws currently in effect, the published practice of tax authorities in those jurisdictions and the double taxation treaties and conventions currently in existence. These laws are subject to change, possibly on a retroactive basis.

### (a) Australian taxation

#### *Dividends*

Dividends (including other distributions treated as dividends for Australian tax purposes) paid by BHP Group Limited to a US holder that is not an Australian resident for Australian tax purposes will generally not be subject to Australian withholding tax if they are fully franked (broadly, where a dividend is franked, tax paid by BHP Group Limited is imputed to the shareholders).

Dividends paid to such US holders, which are not fully franked, will generally be subject to Australian withholding tax not exceeding 15 per cent only to the extent (if any) that the dividend is neither:

- franked; nor
- declared by BHP Group Limited to be conduit foreign income. Broadly, this means that the relevant part of the dividend is declared to have been paid out of foreign source amounts received by BHP Group Limited that are not subject to tax in Australia, such as dividends remitted to Australia by foreign subsidiaries.

The Australian withholding tax outcome described above applies to US holders who are eligible for benefits under the Tax Convention between Australia and the US as to the Avoidance of Double Taxation (the Australian Tax Treaty) that are not companies that directly hold at least 10 per cent of the voting power of BHP Group Limited. If a US holder is not eligible for benefits under the Australian Tax Treaty, the rate of Australian withholding tax may be 30 per cent. If a US holder is eligible for benefits under the Australian Tax Treaty and is a company that directly holds at least 10 per cent of the voting power of BHP Group Limited, the rate is 5 per cent.

In contrast, dividends (including other distributions treated as dividends for Australian tax purposes) paid by BHP Group Limited to a US holder may instead be taxed by assessment in Australia if the US holder:

- is considered to be also an Australian resident for Australian tax purposes. In this case, any franking credits attached to the distribution will be creditable against their Australian income tax liability, and if the US holder is eligible for benefits under the Australian Tax Treaty as a treaty resident of the US, any remaining Australian tax will generally be capped at 15 per cent of the gross dividend; or
- carries on business in Australia through a permanent establishment as defined in the Australian Tax Treaty, or performs personal services from a fixed base in Australia, and the shareholding in respect of which the dividend is paid is effectively connected with that permanent establishment or fixed base. However, in such a case any franking credits may be creditable against the Australian income tax liability.

*The treatment of dividends outlined above may be modified where the shareholding in BHP Group Limited is held through a trust, limited partnership, limited liability company, pension fund, sovereign wealth fund or other investment vehicle. Affected US holders should seek their own advice in relation to such arrangements.*

#### *Sale of ordinary shares and ADSs*

Gains made by US holders on the sale of ordinary shares or ADSs will generally not be taxed in Australia.

However, the precise Australian tax treatment of gains made by US holders on the sale of ordinary shares or ADSs generally depends on whether or not the gain is an Australian sourced gain of an income nature for Australian income tax purposes.



Where the gain is of an income nature, a US holder will generally only be liable to Australian income tax on an assessment basis (whether or not they are also an Australian resident for Australian tax purposes) if:

- they are not eligible for benefits under the Australian Tax Treaty and the gain is sourced in Australia for Australian tax purposes; or
- they are eligible for benefits under the Australian Tax Treaty but the gain constitutes any of the following (in which case the gain will be deemed to have an Australian source):
  - business profits of an enterprise attributable to a permanent establishment situated in Australia through which the enterprise carries on business in Australia; or
  - income or gains from the alienation of property that form part of the business property of a permanent establishment of an enterprise that the US holder has in Australia, or pertain to a fixed base available to the US holder in Australia for the purpose of performing independent personal services; or
  - income derived from the disposition of shares in a company, the assets of which consist wholly or principally of real property (which includes rights to exploit or to explore for natural resources) situated in Australia, whether such assets are held directly or indirectly through one or more interposed entities.

Where the gain is not taxed as Australian sourced income, the US holder will generally only be liable to Australian capital gains tax on an assessment basis if they acquired (or are deemed to have acquired) their shares or ADSs after 19 September 1985 and one or more of the following applies:

- the US holder is an Australian resident for Australian tax purposes; or
- the ordinary shares or ADSs have been used by the US holder in carrying on a business through a permanent establishment in Australia; or
- the ordinary shares or ADSs constitute an ‘indirect Australian real property interest’ for Australian capital gains tax (CGT) purposes. This will generally be the case if the US holder (either alone or together with associates) directly or indirectly owns or owned 10 per cent or more of the issued share capital of BHP Group Limited at the time of the disposal or throughout a 12-month period during the two years prior to the time of disposal and, at the time of the disposal, the sum of the market values of BHP Group Limited’s assets that are taxable Australian real property (held directly or through interposed entities) exceeds the sum of the market values of BHP Group Limited’s assets (held directly or through interposed entities) that are not taxable Australian real property (which, for these purposes includes mining, quarrying or prospecting rights in respect of minerals, petroleum or quarry materials situated in Australia); or
- the US holder is an individual who is not eligible for benefits under the Australian Tax Treaty as a treaty resident of the US and elected on becoming a non-resident of Australia to continue to have the ordinary shares or ADSs subject to Australian capital gains tax.

In certain circumstances, if the ordinary shares or ADSs constitute an ‘indirect Australian real property interest’ for Australian CGT purposes, the purchaser may be required to withhold under the non-resident CGT withholding regime an amount equal to 12.5 per cent of the purchase price in situations including where the acquisition is undertaken by way of an off-market transfer. Affected US holders should seek their own advice in relation to how this withholding regime may apply to them.

The comments above on the sale of ordinary shares and ADSs do not apply:

- to temporary residents of Australia who should seek advice that is specific to their circumstances; or
- if the Investment Management Regime (IMR) applies to the US holder, which exempts from Australian income tax and CGT gains made on disposals by certain categories of non-resident funds (called IMR entities) of portfolio interests in Australian public companies (subject to a number of conditions). The IMR exemptions broadly apply to widely held IMR entities in relation to their direct investments and indirect investments made through an independent Australian fund manager. The exemptions apply to gains made by IMR entities that are treated as companies for Australian tax purposes as well as gains made by non-resident investors in IMR entities that are treated as trusts and partnerships for Australian tax purposes.

#### *Stamp duty, gift, estate and inheritance tax*

Australia does not impose any stamp duty, gift, estate or inheritance taxes in relation to transfers or gifts of shares or ADSs or upon the death of a shareholder.

#### **(b) US taxation**

This section describes the material US federal income tax consequences to a US holder of owning ordinary shares or ADSs. It applies only to ordinary shares or ADSs that are held as capital assets for tax purposes. This discussion addresses only US federal income taxation and does not discuss all of the tax consequences that may be relevant to US holders in light of their individual circumstances, including foreign, state or local tax consequences, estate and gift tax consequences, and tax consequences arising under the Medicare contribution tax on net investment income. This section does not apply to a holder of ordinary shares or ADSs that is a member of a special class of holders subject to special rules, including a dealer in securities, a trader in securities that elects to use a mark-to-market method of accounting for its securities holdings, a tax-exempt organisation, a life insurance company, a person liable for alternative minimum tax, a person who actually or constructively owns 10 per cent or more of the combined voting power of the voting stock or of the total value of the stock of BHP Group Limited, a person that holds ordinary shares or ADSs as part of a straddle or a hedging or conversion transaction, a person that purchases or sells ordinary shares or ADSs as part of a wash sale for tax purposes, or a person whose functional currency is not the US dollar.

If an entity or arrangement that is treated as a partnership for US federal income tax purposes holds the ordinary shares or ADSs, the US federal income tax treatment of a partner generally will depend on the status of the partner and the tax treatment of the partnership. A partner in a partnership holding the ordinary shares or ADSs should consult its tax adviser with regard to the US federal income tax treatment of an investment in the ordinary shares or ADSs.

This section is based on the Internal Revenue Code of 1986, as amended, its legislative history, existing and proposed regulations, published rulings and court decisions, and the Australian Tax Treaty, all as currently in effect. These authorities are subject to change, possibly on a retroactive basis.

This section is in part based on the representations of the Depositary and the assumption that each obligation in the deposit agreement and any related agreement will be performed in accordance with its terms.

In general, for US federal income tax purposes, a holder of ADSs will be treated as the owner of the ordinary shares represented by those ADSs. Exchanges of ordinary shares for ADSs, and ADSs for ordinary shares, generally will not be subject to US federal income tax.

### *Dividends*

Under US federal income tax laws and subject to the Passive Foreign Investment Company (PFIC) rules discussed below, a US holder must include in its gross income the amount of any dividend paid by BHP Group Limited out of its current or accumulated earnings and profits (as determined for US federal income tax purposes) plus any Australian tax withheld from the dividend payment even though the holder does not receive it. The dividend is taxable to the holder when the holder, in the case of ordinary shares, or the Depositary, in the case of ADSs, actually or constructively receives the dividend.

Dividends paid to a non-corporate US holder on shares or ADSs will be taxable at the preferential rates applicable to long-term capital gains provided the US holder holds the shares or ADSs for more than 60 days during the 121-day period beginning 60 days before the ex-dividend date and does not enter into certain risk reduction transactions with respect to the shares or ADSs during the abovementioned holding period. However, a non-corporate US holder that elects to treat the dividend income as 'investment income' pursuant to Section 163(d)(4) of the US Internal Revenue Code will not be eligible for such preferential rates. In the case of a corporate US holder, dividends on shares and ADSs are taxed as ordinary income and will not be eligible for the dividends received deduction generally allowed to US corporations in respect of dividends received from other US corporations.

Distributions in excess of current and accumulated earnings and profits, as determined for US federal income tax purposes, will be treated as a non-taxable return of capital to the extent of the holder's tax basis, determined in US dollars, in the ordinary shares or ADSs and thereafter as a capital gain. However, BHP Group Limited does not expect to calculate earnings and profits in accordance with US federal income tax principles. Accordingly, holders should expect to generally treat distributions made by BHP Group Limited as dividends.

The amount of any cash distribution paid in any foreign currency will be equal to the US dollar value of such currency, calculated by reference to the spot rate in effect on the date such distribution is received by the US holder or, in the case of ADSs, by the Depositary, regardless of whether and when the foreign currency is in fact converted into US dollars. If the foreign currency is converted into US dollars on the date received, the US holder generally should not recognise foreign currency gain or loss on such conversion. If the foreign currency is not converted into US dollars on the date received, the US holder will have a basis in the foreign currency equal to its US dollar value on the date of the distribution, and generally will recognise foreign currency gain or loss on a subsequent conversion or other disposal of such currency. Such foreign currency gain or loss generally will be treated as ordinary income or loss ineligible for the preferential tax rate applicable to dividend income and generally will be income or loss from US sources for foreign tax credit limitation purposes.

Subject to certain limitations, Australian tax withheld in accordance with the Australian Tax Treaty and paid over to Australia will be creditable against an individual's US federal income tax liability. Special rules apply in determining the foreign tax credit limitation with respect to dividends that are taxed at the preferential rates applicable to long-term capital gains. To the extent a reduction or refund of the tax withheld is available to a US holder under Australian law or under the Australian Tax Treaty, the amount of tax withheld that could have been reduced or that is refundable will not be eligible for credit against the holder's US federal income tax liability. A US holder that does not elect to claim a US foreign tax credit may instead claim a deduction for Australian income tax withheld, but only for a taxable year in which the US holder elects to do so with respect to all foreign income taxes paid or accrued in such taxable year.

Dividends will be income from sources outside the US, and generally will be 'passive category' income for the purpose of computing the foreign tax credit allowable to a US holder. In general, a taxpayer's ability to use foreign tax credits may be limited and is dependent on the particular circumstances. US holders should consult their tax advisers with respect to these matters.

### *Sale of ordinary shares and ADSs*

Subject to the PFIC rules discussed below, a US holder who sells or otherwise disposes of ordinary shares or ADSs will recognise a capital gain or loss for US federal income tax purposes equal to the difference between the US dollar value of the amount realised and the holder's tax basis, determined in US dollars, in those ordinary shares or ADSs. The gain or loss will generally be income or loss from sources within the US for foreign tax credit limitation purposes. The capital gain of a non-corporate US holder is generally taxed at preferential rates where the holder has a holding period greater than 12 months in the shares or ADSs sold. There are limitations on the deductibility of capital losses.

The US dollar value of any foreign currency received upon a sale or other disposition of ordinary shares or ADSs will be calculated by reference to the spot rate in effect on the date of sale or other disposal (or, in the case of a cash basis or electing accrual basis taxpayer, on the settlement date). A US holder will have a tax basis in the foreign currency received equal to that US dollar amount, and generally will recognise foreign currency gain or loss on a subsequent conversion or other disposal of the foreign currency. This foreign currency gain or loss generally will be treated as US source ordinary income or loss for foreign tax credit limitation purposes.

*Passive Foreign Investment Company rules*

We do not believe that the BHP Group Limited ordinary shares or ADSs will be treated as stock of a PFIC for US federal income tax purposes, but this conclusion is a factual determination that was made at the end of FY2024 and thus may be subject to change. If BHP Group Limited were treated as a PFIC, any gain realised on the sale or other disposition of ordinary shares or ADSs would in general not be treated as a capital gain. Instead, a US holder would be treated as if it had realised such gain and certain 'excess distributions' ratably over its holding period for the ordinary shares or ADSs and would be taxed at the highest tax rate in effect for each such year to which the gain was allocated, together with an interest charge in respect of the tax attributable to each such year. In addition, dividends received with respect to ordinary shares or ADSs would not be eligible for the preferential tax rates applicable to dividend income if BHP Group Limited were a PFIC either in the taxable year of the distribution or the preceding taxable year, but instead would be taxable at rates applicable to ordinary income. Assuming the shares or ADSs are 'marketable stock', a US holder may mitigate the adverse tax consequences described above by electing to be taxed annually on a mark-to-market basis with respect to such shares or ADSs.

For personal use only

## 10. Glossary

### 10.1 Mining-related terms

#### 3D

Three dimensional.

#### APEGS

Association of Professional Engineers and Geoscientists of Saskatchewan.

#### ASPB

Alberta Society of Professional Biologists

#### AusIMM

The Australasian Institute of Mining and Metallurgy.

#### Beneficiation

The process of physically separating ore from waste material prior to subsequent processing of the improved ore.

#### Bituminous

Coal of intermediate rank with relatively high carbon content.

#### Block cave

An area resulting from an underground mining method where the orebody is undermined to make it collapse under its own weight.

#### Brownfield

The development or exploration located inside the area of influence of existing mine operations which can share infrastructure/management.

#### Coal reserves

Equivalent to mineral reserves, but specifically concerning coal.

#### Coal resources

Equivalent to mineral resources, but specifically concerning coal.

#### Coking coal

Used in the manufacture of coke, which is used in the steelmaking process by virtue of its carbonisation properties. Coking coal may also be referred to as metallurgical coal.

#### Copper cathode

Electrolytically refined copper that has been deposited on the cathode of an electrolytic bath of acidified copper sulphate solution. The refined copper may also be produced through leaching and electrowinning.

#### Cut-off grade

Cut-off grade is the grade (i.e., the concentration of metal or mineral in rock) that determines the destination of the material during mining. For purposes of establishing “prospects of economic extraction,” the cut-off grade is the grade that distinguishes material deemed to have no economic value (it will not be mined in underground mining or if mined in surface mining, its destination will be the waste dump) from material deemed to have economic value (its ultimate destination during mining will be a processing facility). Other terms used in similar fashion as cut-off grade include net smelter return, pay limit, and break-even stripping ratio.

#### Development stage

Development stage, as used in “Additional Information — Information on mining operations”, refers to a property that has mineral reserves disclosed, pursuant to S-K 1300, but no material extraction.

#### Economically viable

Economically viable, when used in the context of mineral reserve determination, means that the qualified person has determined, using a discounted cash flow analysis, or has otherwise analytically determined, that extraction of the mineral reserve is economically viable under reasonable investment and market assumptions.

#### Electrowinning/electrowon

An electrochemical process in which metal is recovered by dissolving a metal within an electrolyte and plating it onto an electrode.

#### Energy coal

Used as a fuel source in electrical power generation, cement manufacture and various industrial applications. Energy coal may also be referred to as steaming or thermal coal.

### **Exploration stage**

Exploration stage, as used in “Additional Information — Information on mining operations”, refers to a property that has no mineral reserves disclosed.

### **Feasibility study**

Feasibility study is a comprehensive technical and economic study of the selected development option for a mineral project, which includes detailed assessments of all applicable modifying factors, together with any other relevant operational factors, and detailed financial analysis that are necessary to demonstrate, at the time of reporting, that extraction is economically viable. The results of the study may serve as the basis for a final decision by a proponent or financial institution to proceed with, or finance, the development of the project.

### **First principles**

First principles refers to building up the costs for a piece of work considering all the parts and activities needed to put it together.

### **Flotation**

A method of selectively recovering minerals from finely ground ore using a froth created in water by specific reagents. In the flotation process, certain mineral particles are induced to float by becoming attached to bubbles of froth and the unwanted mineral particles sink.

### **Full Scale**

A processing technology which allows the extraction of copper using chlorine-assisted leaching predominantly for sulphidic material.

### **Grade or Quality**

Any physical or chemical measurement of the characteristics of the material of interest in samples or product.

### **Greenfield**

The development or exploration located outside the area of influence of existing mine operations/infrastructure.

### **Hypogene Sulphide**

Hypogene mineralisation is formed by fluids at high temperature and pressure derived from magmatic activity. Copper in Hypogene Sulphide is mainly provided from the copper bearing mineral chalcopyrite and higher metal recoveries are achieved via grinding/flotation concentration processes.

### **Indicated mineral resources**

Indicated mineral resource is that part of a mineral resource for which quantity, grade or quality are estimated on the basis of adequate geological evidence and sampling. The level of geological certainty associated with an indicated mineral resource is sufficient to allow a qualified person to apply modifying factors in sufficient detail to support mine planning and evaluation of the economic viability of the deposit. Because an indicated mineral resource has a lower level of confidence than the level of confidence of a measured mineral resource, an indicated mineral resource may only be converted to a probable mineral reserve.

### **Inferred mineral resources**

Inferred mineral resource is that part of a mineral resource for which quantity and grade or quality are estimated on the basis of limited geological evidence and sampling. The level of geological uncertainty associated with an inferred mineral resource is too high to apply relevant technical and economic factors likely to influence the prospects of economic extraction in a manner useful for evaluation of economic viability. Because an inferred mineral resource has the lowest level of geological confidence of all mineral resources, which prevents the application of the modifying factors in a manner useful for evaluation of economic viability, an inferred mineral resource may not be considered when assessing the economic viability of a mining project, and may not be converted to a mineral reserve.

### **In situ**

Situated in the original place.

### **JORC**

The Australasian Joint Ore Reserves Committee.

### **JORC Code**

A set of minimum standards, recommendations and guidelines for public reporting in Australasia of Exploration Results, Mineral Resources and Ore Reserves. The guidelines are defined by JORC, which is sponsored by the Australian mining industry and its professional organisations.

### **Leaching**

The process by which a soluble metal can be economically recovered from minerals in ore by dissolution.

### **Limited geological evidence**

Limited geological evidence, when used in the context of mineral resource determination, means evidence that is only sufficient to establish that geological and grade or quality continuity are more likely than not.

### **LOI (loss on ignition)**

A measure of the percentage of volatile matter (liquid or gas) contained within a mineral or rock. LOI is determined to calculate loss in mass when subjected to high temperatures.

### **Marketable coal reserves**

Tonnes of coal available, at specified moisture content and air-dried qualities, for sale after the beneficiation of coal reserves.

### **Material of economic interest**

Material of economic interest, when used in the context of mineral resource determination, includes mineralisation, including dumps and tailings, mineral brines, and other resources extracted on or within the earth's crust. It does not include oil and gas resources resulting from oil and gas producing activities, gases (e.g., helium and carbon dioxide), geothermal fields, and water.

### **Measured mineral resources**

Measured mineral resource is that part of a mineral resource for which quantity, grade or quality are estimated on the basis of conclusive geological evidence and sampling. The level of geological certainty associated with a measured mineral resource is sufficient to allow a qualified person to apply modifying factors in sufficient detail to support detailed mine planning and final evaluation of the economic viability of the deposit. Because a measured mineral resource has a higher level of confidence than the level of confidence of either an indicated mineral resource or an inferred mineral resource, a measured mineral resource may be converted to a proven mineral reserve or to a probable mineral reserve.

### **Metallurgical coal**

A broader term than coking coal, which includes all coals used in steelmaking, such as coal used for the pulverised coal injection process.

### **Mineral resources**

A mineral resource is a concentration or occurrence of material of economic interest in or on the Earth's crust in such form, grade or quality, and quantity that there are reasonable prospects for economic extraction. A mineral resource is a reasonable estimate of mineralisation, taking into account relevant factors such as cut-off grade, likely mining dimensions, locations or continuity, that, with the assumed and justifiable technical and economic conditions, is likely to, in whole or in part, become economically extractable. It is not merely an inventory of all mineralisation drilled or sampled.

### **Mineralisation**

Any single mineral or combination of minerals occurring in a mass, or deposit, of economic interest.

### **Mineral reserve**

Mineral reserve is an estimate of tonnage and grade or quality of indicated and measured mineral resources that, in the opinion of the qualified person, can be the basis of an economically viable project. More specifically, it is the economically mineable part of a measured or indicated mineral resource, which includes diluting materials and allowances for losses that may occur when the material is mined or extracted.

### **Mixed (ore type)**

Mixed ore type is a term used to describe the zone of mineralisation that is a gradation between Supergene Sulphide and Hypogene Sulphide resulting from the incomplete development of the former as it overprints the latter. This results in a more irregular distribution of the three main copper bearing minerals and is amenable to both grinding/flotation concentration and leaching processes.

### **Modifying Factors**

Modifying factors are the factors that a qualified person must apply to indicated and measured mineral resources and then evaluate in order to establish the economic viability of mineral reserves. A qualified person must apply and evaluate modifying factors to convert measured and indicated mineral resources to proven and probable mineral reserves. These factors include, but are not restricted to: Mining; processing; metallurgical; infrastructure; economic; marketing; legal; environmental compliance; plans, negotiations, or agreements with local individuals or groups; and governmental factors. The number, type and specific characteristics of the modifying factors applied will necessarily be a function of and depend upon the mineral, mine, property, or project.

### **Open cut (OC)**

Surface working in which the working area is kept open to the sky, equivalent term is open pit.

### **Probable mineral reserve**

Probable mineral reserve is the economically mineable part of an indicated and, in some circumstances, a measured mineral resource.

### **Production stage**

Production stage, as used in "Additional Information—Information on mining operations", refers to a property with material extraction of mineral reserves.

### **Proven mineral reserve**

Proven mineral reserve is the economically mineable part of a measured mineral resource and can only result from conversion of a measured mineral resource.

### **Qualified Person**

Defined by US SEC as an individual who is both (1) a mineral industry professional with at least five years of relevant experience in the type of mineralisation and type of deposit under consideration and in the specific type of activity that person is undertaking on behalf of the registrant; and (2) an eligible member or licensee in good standing of a recognised professional organisation at the time the technical report is prepared.

**ROM (run of mine)**

Run of mine product mined in the course of regular mining activities. Tonnes include allowances for diluting materials and for losses that occur when the material is mined.

**Smelting**

The process of extracting metal from its ore by heating and melting.

**Solvent extraction**

A method of separating one or more metals from a leach solution by treating with a solvent that will extract the required metal, leaving the others. The metal is recovered from the solvent by further treatment.

**Sub-level cave**

An area within an underground mine which uses the sub-level cave method. This is where an orebody is extracted from the upper horizons first and mining progresses downwards level by level.

**Supergene Sulphide**

Supergene is a term used to describe near-surface processes and their products, formed at low temperature and pressure by the activity of meteoric or surface water. Copper in Supergene Sulphide is mainly provided from the copper bearing minerals chalcocite and covellite and is amenable to both grinding/flotation concentration and leaching processes.

**Tailings**

Those portions of washed or milled ore that are too poor to be treated further or remain after the required metals and minerals have been extracted.

**Total mineral resources**

The sum of inferred, indicated and measured mineral resources.

**Troy oz**

Troy ounce is a unit of measure of precious metals.

**TSF**

Tailings storage facility/facilities.

**Underground (UG)**

Below the surface mining activities.

**Wet tonnes**

Production is usually quoted in terms of wet metric tonnes (wmt). To adjust from wmt to dry metric tonnes (dmt) a factor is applied based on moisture content.

**Yield**

The percentage of material of interest that is extracted during mining and/or processing.

## 10.2 Terms used in reserves and resources

<b>Ag</b>	silver
<b>Al<sub>2</sub>O<sub>3</sub></b>	alumina
<b>Ash</b>	inorganic material remaining after combustion
<b>Au</b>	gold
<b>Cu</b>	copper
<b>CV</b>	calorific value
<b>Fe</b>	iron
<b>Insol.</b>	insolubles
<b>K<sub>2</sub>O</b>	potassium oxide
<b>KCl</b>	potassium chloride
<b>KCl.MgCl<sub>2</sub>.6H<sub>2</sub>O</b>	carnallite
<b>LOI</b>	loss on ignition
<b>LPL</b>	Lower Patience Lake (stratigraphic unit)
<b>MgO</b>	magnesium oxide
<b>Mo</b>	molybdenum
<b>Ni</b>	nickel
<b>P</b>	phosphorous
<b>Pc</b>	phosphorous in concentrate
<b>S</b>	sulphur
<b>SiO<sub>2</sub></b>	silica
<b>Th</b>	thermal coal
<b>U<sub>3</sub>O<sub>8</sub></b>	uranium oxide
<b>VM</b>	volatile matter
<b>Zn</b>	zinc



### 10.3 Units of measure

<b>%</b>	percentage or per cent
<b>CO<sub>2</sub>-e</b>	carbon-dioxide equivalent
<b>dmt</b>	dry metric tonne
<b>Gj</b>	gigajoule
<b>g/t</b>	grams per tonne
<b>ha</b>	hectare
<b>kcal/kg</b>	kilocalories per kilogram
<b>kg/tonne or kg/t</b>	kilograms per tonne
<b>km</b>	kilometre
<b>ktoz</b>	thousand troy ounces
<b>kt</b>	kilotonnes
<b>ktpa</b>	kilotonnes per annum
<b>ktpd</b>	kilotonnes per day
<b>kV</b>	kilovolt
<b>kW</b>	kilowatt
<b>kWh</b>	kilowatt hour
<b>lb</b>	pound
<b>m</b>	metre
<b>m<sup>3</sup></b>	cubic metre
<b>ML</b>	megalitre
<b>Mt</b>	million tonnes
<b>MtCO<sub>2</sub>-e</b>	million tonnes of carbon dioxide equivalent
<b>Mtpa</b>	million tonnes per annum
<b>MW</b>	megawatt
<b>oz</b>	troy ounce
<b>ppm</b>	parts per million
<b>t</b>	tonne
<b>tCO<sub>2</sub>-e</b>	tonnes of carbon dioxide equivalent
<b>tpa</b>	tonnes per annum
<b>tpd</b>	tonnes per day
<b>TW</b>	terawatt
<b>TWh</b>	terawatt hour
<b>wmt</b>	wet metric tonnes

## 10.4 Other terms

### 2030 goals

Our aspirational goals for FY2030 under the pillars of our 2030 social value scorecard: Decarbonisation; Healthy environment; Indigenous partnerships; Safe, inclusive and future-ready workforce, Thriving, empowered communities and Responsible supply chains.

### AASB (Australian Accounting Standards Board)

Accounting standards as issued by the Australian Accounting Standards Board.

### Activity data (in relation to greenhouse gas (GHG) emissions data)

A quantitative measure of a level of activity that results in GHG emissions. Activity data is multiplied by an energy and/or emissions factor to derive the energy consumption and GHG emissions associated with a process or an operation. Examples of activity data include kilowatt-hours of electricity used, quantity of fuel used, output of a process, hours equipment is operated, distance travelled and floor area of a building.

### Adjusted/unadjusted (in respect to GHG emissions data)

Adjusted means calculated to present the GHG emissions data for a time period (such as a baseline year or reporting year) as though relevant changes took effect from the start of that period even though they occurred during or not until after the end of the period. Unless expressly stated otherwise, relevant changes are all acquisitions, divestments and/or GHG emission calculation methodology changes. For example, when we adjust the FY2020 baseline year for our operational GHG emission target and goal to compare our adjusted FY2024 performance data against it:

- the FY2020 data is presented with Scopes 1 and 2 emissions for operated assets that have been acquired or divested by BHP added or removed (respectively), and applying methodology changes that took effect, between 1 July 2019 and 30 June 2024; and
- the FY2024 data is presented as though any acquisitions, divestments and/or methodology changes that occurred during the year took effect from the start of the year

This enables a 'like for like' comparison that provides the information most relevant to assessing progress against our GHG emissions targets and goals.

Unadjusted means calculated to present the GHG emissions data for a reporting year so that any relevant changes that occurred during the year (including acquisitions, divestments and/or methodology changes) are applied only from the date they took effect.

### Adjustments (in respect of our GHG emissions targets and goals)

Calculations to present GHG emissions data on an adjusted basis.

### ADR (American Depositary Receipt)

An instrument evidencing American Depositary Shares or ADSs, which trades on a stock exchange in the United States.

### ADS (American Depositary Share)

A share issued under a deposit agreement that has been created to permit US-resident investors to hold shares in non-US companies and, if listed, trade them on the stock exchanges in the United States. ADSs are evidenced by American Depositary Receipts, or ADRs, which are the instruments that, if listed, trade on a stock exchange in the United States.

### ASIC (Australian Securities and Investments Commission)

The Australian Government agency that enforces laws relating to companies, securities, financial services and credit in order to protect consumers, investors and creditors.

## **Assets**

Assets are a set of one or more geographically proximate operations (including open-cut mines and underground mines). Assets include our operated and non-operated assets.

## **ASX (Australian Securities Exchange)**

ASX is a multi-asset class vertically integrated exchange group that functions as a market operator, clearing house and payments system facilitator. It oversees compliance with its listing and operating rules, promotes standards of corporate governance among Australia's listed companies and helps educate retail investors.

## **Baseline/baseline year (in relation to GHG emissions targets and goals)**

A year used as a basis to compare and measure performance of future years.

## **BHP**

BHP Group Limited and its subsidiaries.

## **BHP Group Limited**

BHP Group Limited.

## **BHP Group Limited share**

A fully paid ordinary share in the capital of BHP Group Limited.

## **BHP Group Limited shareholders**

The holders of BHP Group Limited shares.

## **BHP Group Plc**

BHP Group Plc (now known as BHP Group (UK) Ltd) and its subsidiaries.

## **BHP Group Plc share**

A fully paid ordinary share in the capital of BHP Group Plc (now known as BHP Group (UK) Ltd).

## **BHP Group Plc shareholders**

The holders of BHP Group Plc shares (prior to unification of the DLC structure).

## **BHP Group (UK) Ltd**

BHP Group (UK) Ltd (formerly known as BHP Group Plc) and its subsidiaries.

## **BHP Healthy environment goal roadmap**

Our Group-level framework for nature-positive plans to achieve the 2030 Healthy environment goal under our social value scorecard, which is intended to apply to our operated assets in Australia, Chile and Canada.

## **BHP shareholders**

In the context of BHP's financial results, BHP shareholders refers to the holders of shares in BHP Group Limited.

## **Biofuel**

A fuel, usually a liquid fuel, produced from renewable biological feedstock sources, such as plant material, vegetation or agricultural waste.

## **Biodiversity**

The variability among living organisms from all sources, including, inter alia, terrestrial, marine and other aquatic ecosystems and the ecological complexes of which they are part; this includes diversity within species, between species and of ecosystems. (Convention on Biological Diversity (1992) Article 2).

## **BMA**

The BHP Mitsubishi Alliance.

## **Board**

The Board of Directors of BHP.

## **BOS**

BHP Operating System.

## **CAF**

BHP's Capital Allocation Framework.

### **Carbon credit**

The reduction or removal of carbon dioxide, or the equivalent amount of a different GHG, using a process that measures, tracks and captures GHGs to compensate for an entity's GHG emissions emitted elsewhere. Credits may be generated through projects in which GHG emissions are avoided, reduced, removed from the atmosphere or permanently stored (sequestration). Carbon credits are generally created and independently verified in accordance with either a voluntary program or under a regulatory program. The purchaser of a carbon credit can 'retire' or 'surrender' it to claim the underlying reduction towards their own GHG emissions reduction targets or goals or to meet legal obligations, which is also referred to as carbon offsetting or offsetting.

We define regulatory carbon credits to mean carbon credits used to offset GHG emissions for regulatory compliance in our operational locations (such as the Safeguard Mechanism in Australia).

We define voluntary carbon credits to mean carbon credits generated through projects that reduce or remove GHG emissions outside the scope of regulatory compliance (including Australian Carbon Credit Units not used for regulatory compliance).

### **Carbon dioxide equivalent**

The universal unit of measurement to indicate the global warming potential (GWP) of each GHG, expressed in terms of the GWP of one unit of carbon dioxide. It is used to evaluate releasing (or avoiding releasing) different GHGs against a common basis.

### **Carbon neutral**

Making or resulting in no net release of GHG emissions into the atmosphere, including as a result of offsetting. Carbon neutral includes all those GHG emissions as defined for BHP reporting purposes.

### **CBWT (context-based water targets)**

Context-based water targets aim to address the water challenges shared by BHP and other stakeholders in the regions where we operate. These targets are based on what we heard from others and our own assessment of water-related risks and opportunities.

### **CMD**

Coal mine dust.

### **CEO Water Mandate**

The CEO Water Mandate is a UN Global Compact initiative that mobilises business leaders on water, sanitation, and the Sustainable Development Goals. Companies that endorse the CEO Water Mandate commit to continuous progress against six core elements of their water stewardship practice and in so doing, better understand and manage their own water risks. The six core areas are: Direct Operations, Supply Chain & Watershed Management, Collective Action, Public Policy, Community Engagement and Transparency. BHP is an active signatory of the Mandate.

### **Commercial**

Our Commercial function seeks to maximise commercial and social value across our end-to-end supply chain. It provides effective and efficient service levels to our assets and customers through world-class insights and market intelligence, deep subject-matter expertise, simple processes and centralised standard activities. The function is organised around the core activities in our inbound and outbound value chains, supported by credit and market risk management, and strategy and planning activities.

### **Community concern**

Broadly classified as any communication to a BHP representative by a member of the community where an issue has not yet necessarily occurred but has the potential/likelihood to escalate into a formal complaint.

### **Community complaint**

A verbal or written notification made directly to a BHP representative by a member of the community relating to an alleged adverse impact on the community arising from BHP's activities and/or employee or contractor behaviour in part or in whole.

### **Company**

BHP Group Limited and its subsidiaries.

### **Continuing operations**

Assets/operations/entities that are owned and/or operated by BHP, excluding assets/operations/entities classified as Discontinued operations.

### **Convention of Biological Diversity**

The Convention on Biological Diversity (CBD) is the international legal instrument for 'the conservation of biological diversity, the sustainable use of its components and the fair and equitable sharing of the benefits arising out of the utilisation of genetic resources' that has been ratified by 196 nations.

### **CTAP 2024**

BHP's second Climate Transition Action Plan, published on 27 August 2024.

### **Directions (Directions for Coal Mines)**

The New South Wales Government Coal Market Price Emergency Directions.

### **Discontinued operations**

Assets/operations/entities that have either been disposed of or are classified as held for sale in accordance with IFRS 5/AASB 5 Non-current Assets Held for Sale and Discontinued operations.

### **Dividend record date**

The date, determined by a company's board of directors, by when an investor must be recorded as an owner of shares in order to qualify for a forthcoming dividend.

### **DLC (Dual Listed Company)**

BHP's Dual Listed Company structure had two parent companies (BHP Group Limited and BHP Group Plc (now known as BHP Group (UK) Ltd)) operating as a single economic entity as a result of the DLC merger. The DLC structure was unified on 31 January 2022.

### **DLC merger**

The Dual Listed Company merger between BHP Group Limited and BHP Group Plc (now known as BHP Group (UK) Ltd) on 29 June 2001.

### **ECR (Economic Contribution Report)**

BHP's Economic Contribution Report for the year ended 30 June 2024.

### **Ecosystem**

A dynamic complex of plant, animal and microorganism communities and the non-living environment, interacting as a functional unit. (Convention on Biological Diversity (1992) Article 2; Intergovernmental Science-Policy Platform on Biodiversity and Ecosystem Services (2019) Global Assessment Report on Biodiversity and Ecosystem Services).

### **Ecosystem function**

The flow of energy and materials through the biotic and abiotic components of an ecosystem. This includes many processes such as biomass production, trophic transfer through plants and animals, nutrient cycling, water dynamics and heat transfer. (Intergovernmental Science-Policy Platform on Biodiversity and Ecosystem Services (2019) Global Assessment Report on Biodiversity and Ecosystem Services).

### **Ecosystem services**

The contributions of ecosystems to the benefits that are used in economic and other human activity. (United Nations et al. (2021) System of Environmental-Economic Accounting—Ecosystem Accounting).

### **ELT (Executive Leadership Team)**

The Executive Leadership Team directly reports to the Chief Executive Officer and is responsible for the day-to-day management of BHP and leading the delivery of our strategic objectives.

### **Emission factor**

A factor that converts activity data into GHG emissions data (e.g. kg CO<sub>2</sub>-e emitted per GJ of fuel consumed, kg CO<sub>2</sub>-e emitted per KWh of electricity used).

### **Energy (in relation to BHP)**

Energy means all forms of energy products where 'energy products' means combustible fuels, heat, renewable energy, electricity or any other form of energy from operations that are owned or controlled by BHP. The primary sources of energy consumption come from fuel consumed by haul trucks at our operated assets, as well as purchased electricity used at our operated assets.

### **Energy content factor**

The energy content of a fuel is an inherent chemical property that is a function of the number and types of chemical bonds in the fuel.

### **Entrained water**

Entrained water includes water incorporated into product and/or waste streams, such as tailings, that cannot be easily recovered.

### **Equity share approach (in relation to GHG emissions data)**

A consolidation approach whereby a company accounts for GHG emissions from operations according to its share of equity in the operation. The equity share reflects economic interest, which is the extent of rights a company has to the risks and rewards flowing from an operation. Also see the definition for Operational control approach.

### **ESG**

Environmental, social and governance.

### **Executive KMP (Key Management Personnel)**

Executive Key Management Personnel includes the Executive Director (our CEO), the Chief Financial Officer, President Australia, President Americas, and the Chief Operating Officer. It does not include the Non-executive Directors (on our Board).

### **Fatality Elimination Program (FEL)**

The Fatality Elimination Program involves all Assets developing control implementation plans. These plans identify the relevant controls required to address their respective operations fatality risks, including timeframes for when control implementation is possible. Progress against these plans is monitored monthly via the BHP FEL dashboard. The aim is to implement and sustain as many 'hard' controls as possible, whilst also recognising that to build a robust control framework it will rely on all elements of the hierarchy of control being available, including soft/administrative controls (i.e. human-dependent controls).

## **Fugitive methane emissions**

Methane emissions that are not physically controlled but result from the intentional or unintentional releases of methane from coal mining.

## **Functions**

Functions operate along global reporting lines to provide support to all areas of the organisation. Functions have specific accountabilities and deep expertise in areas such as finance, legal, governance, technology, human resources, corporate affairs, health, safety and community.

## **Future-facing commodity**

A commodity that BHP determines to be positively leveraged in the energy transition and broader global response to climate change, with potential for decades-long demand growth to support emerging megatrends like electrification and decarbonisation. Currently, the major commodities in the BHP portfolio that fall within this criterion include copper, nickel and potash.

## **GBF (Kunming-Montreal Global Biodiversity Framework)**

The Kunming-Montreal Global Biodiversity Framework is a set of targets and goals adopted by the 15th Conference of Parties (COP15) to the United Nations Convention on Biological Diversity (CBD) in December 2022 that aims to address the loss of biodiversity and restore natural ecosystems by 2030.

## **Gearing ratio**

The ratio of net debt to net debt plus net assets.

## **GHG (greenhouse gas)**

For BHP reporting purposes, these are the aggregate anthropogenic carbon dioxide equivalent emissions of carbon dioxide (CO<sub>2</sub>), methane (CH<sub>4</sub>), nitrous oxide (N<sub>2</sub>O), hydrofluorocarbons (HFCs), perfluorocarbons (PFCs) and sulphur hexafluoride (SF<sub>6</sub>). Nitrogen trifluoride (NF<sub>3</sub>) GHG emissions are currently not relevant for BHP reporting purposes. GHG emissions in this report are presented in tonnes CO<sub>2</sub>-e or its multiples, unless otherwise stated.

## **GISTM**

Global Industry Standards on Tailings Management.

## **Global goal for nature**

The global goal for nature defines what is needed to halt and reverse today's current state of loss of nature. It is supported by a number of organisations that ask governments to adopt the goal at the international level, which each country, the private sector, communities and others can contribute to achieving.

## **Goal (for BHP with respect to GHG emissions)**

An ambition to seek an outcome for which there is no current pathway(s), but for which efforts are being or will be pursued towards addressing that challenge, subject to certain assumptions or conditions. Such efforts may include the resolution of existing potential or emerging pathways.

## **Goals of the Paris Agreement**

The central objective of the Paris Agreement is its long-term temperature goal to hold the global average temperature increase to well below 2°C above pre-industrial levels and pursue efforts to limit the temperature increase to 1.5°C above pre-industrial levels.

## **Grievance**

An event or *community complaint* relating to an adverse impact/event that has escalated to the point where a third-party intervention or adjudication is required to resolve.

## **GRI (Global Reporting Initiative)**

The Global Reporting Initiative works with businesses and governments to understand and communicate their impact on critical sustainability issues.

## **Groundwater**

Water beneath the earth's surface, including beneath the seabed, which fills pores or cracks between porous media, such as soil, rock, coal, and sand, often forming aquifers. Groundwater may be abstracted for use from bore fields or accessed via dewatering to access ore. For accounting purposes, water that is entrained in the ore can be considered as groundwater.

## **Group**

BHP Group Limited and its subsidiaries.

## **GWP (global warming potential)**

A factor describing the radiative forcing impact (degree of harm to the atmosphere) of one unit of a given GHG relative to one unit of CO<sub>2</sub>. BHP currently uses GWP from the Intergovernmental Panel on Climate Change (IPCC) Assessment Report 5 (AR5) based on a 100-year timeframe.

## **HPI (high-potential injuries)**

High-potential injuries are recordable injuries and first aid cases where there was the potential for a fatality.

## **ICMM (International Council on Mining and Metals)**

The International Council on Mining and Metals is an international organisation dedicated to a safe, fair and sustainable mining and metals industry.

**IFRS (International Financial Reporting Standards)**

Accounting standards as issued by the International Accounting Standards Board.

**Indigenous Peoples Policy Statement**

Articulates BHP's approach to engaging with and supporting Indigenous peoples.

**IPCC (Intergovernmental Panel on Climate Change)**

The Intergovernmental Panel on Climate Change is the United Nations body for assessing the science related to climate change.

**IUCN (International Union for Conservation of Nature)**

The International Union for Conservation of Nature is an international organisation working in the field of nature conservation and sustainable use of natural resources.

**KMP (Key Management Personnel)**

Key Management Personnel includes the roles which have the authority and responsibility for planning, directing and controlling the activities of BHP. These are Non-executive Directors, the CEO, the Chief Financial Officer, the President Australia, the President Americas.

**KPI (key performance indicator)**

Used to measure the performance of the Group, individual businesses and executives in any one year.

**Legacy assets**

Legacy assets refer to those BHP operated assets, or part thereof, located in the Americas that are in the closure phase.

**LME (London Metal Exchange)**

A major futures exchange for the trading of industrial metals.

**Location-based reporting (in relation to GHG emissions data)**

Scope 2 emissions based on average energy generation emission factors for defined geographic locations, including local, subnational, or national boundaries (i.e. grid factors). In the case of a direct line transfer, the location-based emissions are equivalent to the market-based emissions.

**Lower GHG emission(s) (for shipping)**

Capable of between 5 per cent to 80 per cent lower GHG emissions intensity (gCO<sub>2</sub>-e/joule) on a well-to-wake basis compared to conventional fossil fuels used in shipping.

**Lower GHG emission(s) (other than shipping fuels)**

Capable of lower absolute GHG emissions or GHG emissions intensity than the current state or the conventional or incumbent technology, as applicable.

**Low to zero GHG emission(s) (for shipping)**

Capable of between 81 per cent to 100 per cent lower GHG emissions intensity (gCO<sub>2</sub>-e/joule) on a well-to-wake basis compared to conventional fossil fuels used in shipping.

**Low to zero GHG emission(s) (for energy products other than shipping fuels)**

Capable of between 90 per cent to 100 per cent lower GHG emissions intensity during generation and/or combustion (as applicable) compared to conventional fossil fuel generation and/or combustion.

**Market-based method/reporting (in relation to GHG emissions data)**

Scope 2 emissions based on the generators (and therefore the generation fuel mix from which the reporter contractually purchases electricity and/or is directly provided electricity via a direct line transfer).

**MFL (Maximum Foreseeable Loss)**

The MFL is the estimated impact to BHP if a risk were to materialise in a worst-case scenario without regard to probability and assuming all controls are ineffective.

**Nature**

The natural world, with an emphasis on the diversity of living organisms (including people) and their interactions among themselves and with their environment. (Adapted from Díaz, S et al. (2015) The IPBES Conceptual Framework – Connecting Nature and People).

**Nature-positive**

A high-level goal and concept describing a future state of nature (e.g. biodiversity, ecosystem services and natural capital) which is greater than the current state. This definition comes from the Taskforce on Nature-related Financial Disclosures (TNFD) Framework – Beta release v0.1.

**Near zero emissions (for steelmaking or ironmaking)**

0.40 tonnes of CO<sub>2</sub>-e per tonne of crude steel for 100 per cent ore-based production (no scrap), as defined by the International Energy Agency (IEA) and implemented in ResponsibleSteel International Standard V2.0 ('near zero' performance level 4 threshold). IEA (2022), Achieving Net Zero Heavy Industry Sectors in G7 Members, IEA, Paris, License: CC BY 4.0, which also describes the boundary for the emission intensity calculation (including in relation to upstream emissions).

**Net zero (for a BHP GHG emissions target, goal or pathway, or similar)**

Net zero includes the use of carbon credits as governed by BHP's approach to carbon offsetting, available at [bhp.com/climate](https://bhp.com/climate).

**Net zero (for industry sectors, the global economy, transition or future, or similar)**

Net zero refers to a state in which the GHGs (as defined in this Glossary) going into the atmosphere are balanced by removal out of the atmosphere.

**NGER (National Greenhouse and Energy Reporting Scheme)**

The Australian National Greenhouse and Energy Reporting scheme is a single national framework for reporting and disseminating company information about GHG emissions, energy production, energy consumption and other information specified under the National Greenhouse and Energy Reporting Act 2007.

**NOJV (non-operated asset/non-operated joint venture)**

Non-operated assets/non-operated joint ventures are our interests in assets that are owned as a joint venture but not operated by BHP. References in this Annual Report to a 'joint venture' are used for convenience to collectively describe assets that are not wholly owned by BHP. Such references are not intended to characterise the legal relationship between the owners of the asset.

**NSWEC**

New South Wales Energy Coal.

**Occupational illness**

An illness that occurs as a consequence of work-related activities or exposure. It includes acute or chronic illnesses or diseases, which may be caused by inhalation, absorption, ingestion or direct contact.

**OELs (occupational exposure limits)**

An OEL is an upper limit on the acceptable concentration of a hazardous substance in workplace air for a particular material or class of materials. OELs may also be set for exposure to physical agents such as noise, vibration or radiation.

**Offsetting (in relation to GHG emissions)**

The use of carbon credits. Refer to the definition of carbon credit.

**OFR**

BHP's Operating and Financial Review for the year ended 30 June 2024.

**Onshore US**

BHP's Petroleum asset (divested in the year ended 30 June 2019) in four US shale areas (Eagle Ford, Permian, Haynesville and Fayetteville), where we produced oil, condensate, gas and natural gas liquids.

**Operated assets**

Operated assets are our assets (including those under exploration, projects in development or execution phases, sites and operations that are closed or in the closure phase) that are wholly owned and operated by BHP or that are owned as a BHP-operated joint venture. References in this Annual Report to a 'joint venture' are used for convenience to collectively describe assets that are not wholly owned by BHP. Such references are not intended to characterise the legal relationship between the owners of the asset.

**Operational control approach (in relation to GHG emissions data)**

A consolidation approach whereby a company accounts for 100 per cent of the GHG emissions over which it has operational control (a company is considered to have operational control over an operation if it or one of its subsidiaries has the full authority to introduce and implement its operating policies at the operation). It does not account for GHG emissions from operations in which it owns an interest but does not have operational control. Also see the definition for Equity share approach.

**Operational GHG emissions**

Our operational GHG emissions are the Scope 1 emissions and Scope 2 emissions from our operated assets.

**Operations**

Open-cut mines, underground mines and processing facilities, which in the case of BHP are within our operated assets.

**Other (with respect to water consumption volumes)**

This includes water volumes used for purposes such as potable water consumption and amenity facilities at our operated assets.

**Paris Agreement**

The Paris Agreement is an agreement between countries party to the United Nations Framework Convention on Climate Change to strengthen efforts to combat climate change and adapt to its effects, with enhanced support to assist developing countries to do so.



**Petroleum (asset group)**

A group of oil and gas assets formerly operated by BHP before its merger with Woodside in June 2022. Petroleum's core production operations were located in the US Gulf of Mexico, Australia and Trinidad and Tobago. Petroleum produced crude oil and condensate, gas and natural gas liquids.

**PPA (power purchasing agreement)**

An agreement between a vendor and purchaser for the sale of electricity, which may be wholly or partially renewable or other low to zero GHG emissions energy and either physically supplied directly to the purchaser or for supply from an electricity grid.

**PPE (personal protective equipment)**

PPE means anything used or worn to minimise risk to a worker's health and safety, including air supplied respiratory equipment.

**Physical climate-related risk**

Acute risks that are event-driven, including increased severity and frequency of extreme weather events and chronic risks resulting from longer-term changes in climate patterns.

**Reference year (for a BHP GHG emissions target or goal)**

A year used to track progress towards GHG emissions targets and goals. It is not a baseline for GHG emissions targets and goals.

**Residual mix**

The mix of energy generation resources and associated attributes, such as GHG emissions in a defined geographic boundary left after contractual instruments have been claimed/retired/cancelled. The residual mix can provide an emission factor for companies without contractual instruments to use in a market-based method calculation. A residual mix is currently unavailable to account for voluntary purchases and this may result in double counting between electricity consumers.

**Safeguard Mechanism**

A mechanism established in Australia under the National Greenhouse and Energy Reporting Act 2007 to keep certain GHG emissions at or below legislated limits, known as baselines, for Australia's largest industrial facilities. Reforms to the Safeguard Mechanism that applied from 1 July 2023 are intended to reduce Scope 1 emissions at Australia's largest industrial facilities on a trajectory consistent with achieving Australia's GHG emission reduction targets of 43 per cent below 2005 levels by 2030 and net zero by 2050. Facilities that exceed their progressively declining legislated baselines may apply Australian Carbon Credit Units to meet the compliance obligations.

**SASB (Sustainability Accounting Standards Board)**

The Sustainability Accounting Standards Board is a non-profit organisation that develops standards focused on the financial impacts of sustainability.

**Scope 1 emissions (GHG emissions)**

Scope 1 emissions are direct GHG emissions from operations that are owned or controlled by the reporting company. For BHP, these are primarily GHG emissions from fuel consumed by haul trucks at our operated assets, as well as fugitive methane emissions from coal production at our operated assets.

**Scope 2 emissions (GHG emissions)**

Scope 2 emissions are indirect GHG emissions from the generation of purchased or acquired electricity, steam, heat or cooling that is consumed by operations that are owned or controlled by the reporting company. BHP's Scope 2 emissions have been calculated using the market-based method unless otherwise specified.

**Scope 3 emissions (GHG emissions)**

Scope 3 are all other indirect GHG emissions (not included in Scope 2 emissions) that occur in the reporting company's value chain. For BHP, these are primarily emissions resulting from our customers using and processing the commodities we sell, as well as upstream emissions associated with the extraction, production and transportation of the goods, services, fuels and energy we purchase for use at our operations; emissions resulting from the transportation and distribution of our products; and operational emissions (on an equity basis) from our non-operated joint ventures.

**SEC (United States Securities and Exchange Commission)**

The US regulatory commission that aims to protect investors, maintain fair, orderly and efficient markets and facilitate capital formation.

**Senior manager**

An employee who has responsibility for planning, directing or controlling the activities of the entity or a strategically significant part of it. In the OFR, senior manager includes senior leaders and any persons who are directors of any subsidiary company even if they are not senior leaders.

**Shareplus**

BHP's all-employee share purchase plan.

**Social investment**

Social investment is our voluntary contribution towards projects or donations with the primary purpose of contributing to the resilience of the communities where we operate and the environment, aligned with our broader business priorities.

## **Social value**

Our positive contribution to society through the creation of mutual benefit for BHP, our shareholders, Indigenous partners and the broader community.

## **South32**

During FY2015, BHP demerged a selection of our alumina, aluminium, coal, manganese, nickel, silver, lead and zinc assets into a new company – South32 Limited.

## **Steelmaking coal**

Metallurgical coal of a sufficient high quality (grade) that it is suitable for use in steelmaking. Refer to Additional information 10.1 for the definition of metallurgical coal and coking coal.

## **Surface water**

All water naturally open to the atmosphere, including rivers, lakes and creeks and external water dams but excluding water from oceans, seas and estuaries (e.g. precipitation and runoff, including snow and hail).

## **Sustainability (including sustainable and sustainably)**

We describe our approach to sustainability and its governance in this Report, including OFR 6. Our references to sustainability (including sustainable and sustainably) in this Report and our other disclosures do not mean we will not have any adverse impact on the economy, the environment or society, and do not imply we will necessarily give primacy to consideration of or achieve any absolute outcome in relation to, any one economic, environmental or social issue (such as zero GHG emissions or other environmental effects).

## **Structural GHG emissions abatement**

Actions taken at a source of GHG emissions to avoid generating GHG emissions. For BHP, this includes contractual power purchase agreements.

## **Target (for BHP with respect to GHG emissions)**

An intended outcome in relation to which we have identified one or more pathways for delivery of that outcome, subject to certain assumptions or conditions.

## **TCFD (Task Force on Climate-Related Financial Disclosures)**

The task force created by the Financial Stability Board to improve and increase reporting of climate-related financial information, which has released recommendations designed to help companies provide better information to investors and others about how they think about and assess climate-related risks and opportunities.

## **Third-party water**

Water supplied by an entity external to the operational facility. Third-party water may contain water from three sources, surface water, groundwater and seawater.

## **Tier 1 asset**

An asset that we believe is large, long life and low cost.

## **TNFD (Taskforce on Nature-related Financial Disclosures)**

The Taskforce on Nature-Related Financial Disclosures is a global, market-led initiative that aims to develop a risk management and disclosure framework for organisations to report and act on evolving nature-related dependencies, impacts, risks and opportunities.

## **Transition risk (climate-related)**

Risks that arise from existing and emerging policy, regulatory, legal, technological, market and other societal responses to the challenges posed by climate change and the transition to a net zero global economy.

## **TRIF (total recordable injury frequency)**

The sum of (fatalities + lost-time cases + restricted work cases + medical treatment cases) x 1,000,000 ÷ actual hours worked. Stated in units of per million hours worked. BHP adopts the US Government Occupational Safety and Health Administration guidelines for the recording and reporting of occupational injury and illnesses. TRIF statistics exclude non-operated assets.

## **TSR (total shareholder return)**

Measures the return delivered to shareholders over a certain period through the movements in share price and dividends paid (which are assumed to be reinvested). It is the measure used to compare BHP's performance to that of other relevant companies under the Long-Term Incentive Plan.

## **Underlying attributable profit**

Profit/(loss) after taxation attributable to BHP shareholders excluding any exceptional items attributable to BHP shareholders as described in Financial Statements note 3 'Exceptional items'. For more information refer to OFR 10.

## **Underlying EBIT**

Earnings before net finance costs, taxation expense, Discontinued operations and any exceptional items. Underlying EBIT includes BHP's share of profit/(loss) from investments accounted for using the equity method including net finance costs and taxation expense/(benefit). For more information refer to OFR 10.

## **Underlying EBITDA**

Earnings before net finance costs, depreciation, amortisation and impairments, taxation expense, Discontinued operations and any exceptional items. Underlying EBITDA includes BHP's share of profit/(loss) from investments accounted for using the equity method including net finance costs, depreciation, amortisation and impairments and taxation expense/(benefit). For more information refer to OFR 10.

## **Unification**

The unification of BHP's corporate structure under BHP Group Limited as effected on 31 January 2022.

## **Unit costs**

One of the financial measures BHP uses to monitor the performance of individual assets. Unit costs are calculated as ratio of net costs of the assets to the equity share of sales tonnage. Net costs is defined as revenue less Underlying EBITDA and excluding freight, and other costs, depending on the nature of each asset. For information on the method of calculation of the unit costs refer to OFR 10.1.

## **United Nations SDGs (Sustainable Development Goals)**

The Sustainable Development Goals, also known as the Global Goals, were adopted by the United Nations in 2015 as a universal call to action to end poverty, protect the planet, and ensure that by 2030 all people enjoy peace and prosperity.

## **Value chain GHG emissions**

Scope 3 emissions in our reported GHG emissions inventory.

## **WAF (Water Accounting Framework)**

A common mining and metals industry approach to water accounting in Australia.

## **Water quality – Type 1**

Water of high quality that would require minimal (if any) treatment to meet drinking water standards. This water is considered high quality/high grade in the ICMM 'Good Practice' Guide (2nd Edition) (2021).

## **Water quality – Type 2**

Water of medium quality that would require moderate treatment to meet drinking water standards (it may have a high salinity threshold of no higher than 5,000 milligrams per litre total dissolved solids and other individual constituents). This water is considered high quality/high grade in the ICMM 'Good Practice' Guide (2nd Edition) (2021).

## **Water quality – Type 3**

Water of low quality that would require significant treatment to meet drinking water standards. It may have individual constituents with high values of total dissolved solids, elevated levels of metals or extreme levels of pH. This type of water also includes seawater. This water is considered low quality/low grade in the ICMM 'Good Practice' Guide (2nd Edition) (2021).

## **Well-to-wake basis**

Inclusive of the GHG emissions across the entire process of fuel production, delivery and use onboard vessels.

## **WRSa (Water Resource Situational Analysis)**

A Water Resource Situational Analysis is a holistic assessment of the water situation where an operated asset operates. The process is designed to describe the water challenges that partners and stakeholders share and the opportunities for collective action to address those challenges. The WRSa is prepared by a credible third party and draws on publicly available information and direct partner and stakeholder input. Within a defined area that includes the water resources that BHP interacts with, each WRSa includes assessment of:

- the ongoing stability of the volume and quality of the water resources, taking into account interactions of all other parties and any related environmental, social or cultural values and climate change forecasts
- the state of water infrastructure, water access, sanitation and hygiene of local communities
- the environmental health of the water catchments that feed the water resources taking into account the extent of vegetation, runoff, and any conservation of the area
- external water governance arrangements and their effectiveness

## Exhibits

Exhibits marked “\*” have been filed as exhibits to this annual report on Form 20-F. Remaining exhibits have been incorporated by reference as indicated.

The agreements and other documents filed as exhibits to this report are not intended to provide factual information or other disclosure other than with respect to the terms of the agreements or other documents themselves, and you should not rely on them for that purpose. Some agreements and other documents contain representations and warranties by each of the parties to the applicable agreement. These representations and warranties have been made solely for the benefit of the other parties to the applicable agreement or other arrangement and (i) should not be treated as categorical statements of fact, but rather as a way of allocating the risk to one of the parties if those statements prove to be inaccurate; (ii) may have been qualified by disclosures that were made to the other party in connection with the negotiation of the applicable agreement, which disclosures are not necessarily reflected in the agreement; (iii) may apply standards of materiality in a way that is different from what may be viewed as material to you or other investors; and (iv) were made only as of the date of the applicable agreement or document or such other date or dates as may be specified in the agreement and are subject to more recent developments. Accordingly, these representations and warranties may not describe the actual state of affairs as of the date they were made or at any other time.

### **Exhibit 1**      **Constitution**

1.1      [Constitution of BHP Group Limited, incorporating the amendments approved by shareholders at the 2022 General Meeting of BHP Group Limited on 20 January 2022 \(incorporated by reference to Exhibit 1.1 to BHP’s Annual Report on Form 20-F \(File No.: 001-09526\) filed with the Securities and Exchange Commission on 6 September 2022\).](#)

### **Exhibit 2**      **Securities**

\*2.1      [Description of Securities](#)

### **Exhibit 4**      **Material Contracts**

\*4.1      [Form of Service Agreement for Specified Executive \(referred to in this Annual Report as the Key Management Personnel\)](#)

\*4.2      [BHP Group Limited Equity and Cash Incentive Plan Rules, adopted on 25 September 2023](#)

4.3      [Framework Agreement entered into on 2 March 2016 between Samarco Mineração S.A., Vale S.A. and BHP Billiton Brasil Ltda, the Federal Government of Brazil, the states of Espírito Santo and Minas Gerais and certain other public authorities in Brazil \(incorporated by reference to Exhibit 4.3 to BHP’s Annual Report on Form 20-F \(File No.: 001-09526\) filed with the Securities and Exchange Commission on 6 September 2022\).](#)

### **Exhibit 8**      **List of Subsidiaries**

\*8.1      [List of subsidiaries of BHP Group Limited](#)

### **Exhibit 11**      **Insider Trading Policies**

\*11.1      [Securities Dealing Policy of BHP Group Limited](#)

### **Exhibit 12**      **Certifications (section 302)**

\*12.1      [Certification by Chief Executive Officer, Mr Mike Henry, dated 30 August 2024](#)

\*12.2      [Certification by Chief Financial Officer, Ms Vandita Pant, dated 30 August 2024](#)

### **Exhibit 13**      **Certifications (section 906)**

\*13.1      [Certification by Chief Executive Officer, Mr Mike Henry, dated 30 August 2024<sup>\(1\)</sup>](#)

\*13.2      [Certification by Chief Financial Officer, Ms Vandita Pant, dated 30 August 2024<sup>\(1\)</sup>](#)

### **Exhibit 15**      **Consents**

\*15.1      [Consent of Independent Registered Public Accounting firms Ernst & Young for incorporation by reference of audit reports in registration statements on Form F-3 and Form S-8](#)

\*15.2      [Consents of Qualified Persons for Technical Report Summary for Jansen Potash Project](#)

**Exhibit 17**      **Guaranteed Securities**

\*17.1      [List of subsidiary guarantors and issuers of guaranteed securities](#)

**Exhibit 96**      **Technical Report Summaries**

96.1      [Technical Report Summary for Minera Escondida Limitada, effective 30 June 2022 \(incorporated by reference to Exhibit 96.1 to BHP's Annual Report on Form 20-F \(File No.: 001-09526\) filed with the Securities and Exchange Commission on 5 September 2023\)](#)

96.2      [Technical Report Summary for Western Australia Iron Ore, effective 30 June 2022 \(incorporated by reference to Exhibit 96.2 to BHP's Annual Report on Form 20-F \(File No.: 001-09526\) filed with the Securities and Exchange Commission on 5 September 2023\)](#)

\*96.3      [Technical Report Summary for Jansen Potash Project, effective 30 June 2024](#)

**Exhibit 101**      **Clawback Policy**

\*97.1      [Malus and Clawback Policy of BHP Group Limited, October 2021 \(updated by the People and Remuneration Committee on 1 November 2022\)](#)

**Exhibit 101**      **Interactive Data File**

\*101.INS      Inline XBRL Instance Document

\*101.SCH      Inline XBRL Taxonomy Extension Schema Document

\*101.CAL      Inline XBRL Taxonomy Extension Calculation Linkbase Document

\*101.DEF      Inline XBRL Taxonomy Extension Definition Linkbase Document

\*101.LAB      Inline XBRL Taxonomy Extension Label Linkbase Document

\*101.PRE      Inline XBRL Taxonomy Extension Presentation Linkbase Document

**Exhibit 104**      **Cover Page Interactive Data File**

\*104      Cover page Interactive Data File (embedded within the Inline XBRL document)

**Footnotes**

(1)      Furnished only.

The total amount of long-term debt securities of BHP Group Limited and its subsidiaries authorised under instruments other than those listed above does not exceed 10% of the total assets of BHP Group Limited and its subsidiaries on a consolidated basis. The company agrees to furnish copies of any such instruments to the Commission upon request.

**SIGNATURE**

The registrant hereby certifies that it meets all of the requirements for filing on Form 20-F and that it has duly caused and authorised the undersigned to sign this annual report on its behalf.

**BHP GROUP LIMITED**

By: /s/ Vandita Pant

Name: Vandita Pant

Title: Chief Financial Officer

Date: 30 August 2024

For personal use only

# Financial Statements

<b>1</b>	<b><u>Consolidated Financial Statements</u></b>	<b>F-1</b>
	<u>1.1 Consolidated Income Statement</u>	F-1
	<u>1.2 Consolidated Statement of Comprehensive Income</u>	F-2
	<u>1.3 Consolidated Balance Sheet</u>	F-3
	<u>1.4 Consolidated Cash Flow Statement</u>	F-4
	<u>1.5 Consolidated Statement of Changes in Equity</u>	F-5
	<u>1.6 Notes to the Financial Statements</u>	F-9
<b>1A</b>	<b><u>Reports of Independent Registered Public Accounting Firm (Auditor Firm ID: 1435)</u></b>	<b>F-78</b>
<b>2</b>	<b><u>Not required for US reporting</u></b>	<b>F-83</b>
<b>3</b>	<b><u>Directors' declaration</u></b>	<b>F-84</b>
<b>4</b>	<b><u>Not required for US reporting</u></b>	<b>F-85</b>
<b>5</b>	<b><u>Included as section 1A</u></b>	<b>F-85</b>
	<b><u>Notes to the Financial Statements</u></b>	
	<b><u>Performance</u></b>	
<b>1</b>	<u>Segment reporting</u>	F-9
<b>2</b>	<u>Revenue</u>	F-12
<b>3</b>	<u>Exceptional items</u>	F-13
<b>4</b>	<u>Significant events – Samarco dam failure</u>	F-16
<b>5</b>	<u>Expenses and other income</u>	F-24
<b>6</b>	<u>Income tax expense</u>	F-25
<b>7</b>	<u>Earnings per share</u>	F-28
	<b><u>Working capital</u></b>	
<b>8</b>	<u>Trade and other receivables</u>	F-29
<b>9</b>	<u>Trade and other payables</u>	F-29
<b>10</b>	<u>Inventories</u>	F-30
	<b><u>Resource assets</u></b>	
<b>11</b>	<u>Property, plant and equipment</u>	F-30
<b>12</b>	<u>Intangible assets</u>	F-33
<b>13</b>	<u>Impairment of non-current assets</u>	F-34
<b>14</b>	<u>Deferred tax balances</u>	F-37
<b>15</b>	<u>Closure and rehabilitation provisions</u>	F-39
<b>16</b>	<u>Climate change</u>	F-42
	<b><u>Capital structure</u></b>	
<b>17</b>	<u>Share capital</u>	F-47
<b>18</b>	<u>Other equity</u>	F-48
<b>19</b>	<u>Dividends</u>	F-49
<b>20</b>	<u>Provisions for dividends and other liabilities</u>	F-49
	<b><u>Financial management</u></b>	
<b>21</b>	<u>Net debt</u>	F-50
<b>22</b>	<u>Leases</u>	F-53
<b>23</b>	<u>Net finance costs</u>	F-55
<b>24</b>	<u>Financial risk management</u>	F-56
	<b><u>Employee matters</u></b>	
<b>25</b>	<u>Key management personnel</u>	F-62
<b>26</b>	<u>Employee share ownership plans</u>	F-62
<b>27</b>	<u>Employee benefits, restructuring and post-retirement employee benefits provisions</u>	F-65
	<b><u>Group and related party information</u></b>	
<b>28</b>	<u>Discontinued operations</u>	F-67
<b>29</b>	<u>Business combinations</u>	F-69
<b>30</b>	<u>Subsidiaries</u>	F-70
<b>31</b>	<u>Investments accounted for using the equity method</u>	F-71
<b>32</b>	<u>Interests in joint operations</u>	F-74
<b>33</b>	<u>Related party transactions</u>	F-74
	<b><u>Unrecognised items and uncertain events</u></b>	
<b>34</b>	<u>Contingent liabilities</u>	F-75
<b>35</b>	<u>Subsequent events</u>	F-75
	<b><u>Other items</u></b>	
<b>36</b>	<u>Auditor's remuneration</u>	F-76
<b>37</b>	<u>Not required for US reporting</u>	F-76
<b>38</b>	<u>Not required for US reporting</u>	F-76
<b>39</b>	<u>New and amended accounting standards and interpretations and changes to accounting policies</u>	F-77

# 1 Consolidated Financial Statements

## 1.1 Consolidated Income Statement for the year ended 30 June 2024

	Notes	2024 US\$M	2023 US\$M	2022 US\$M
<b>Continuing operations</b>				
Revenue	2	55,658	53,817	65,098
Other income	5	1,285	394	1,398
Expenses excluding net finance costs	5	(36,750)	(31,873)	(32,371)
(Loss)/profit from equity accounted investments, related impairments and expenses	31	(2,656)	594	(19)
<b>Profit from operations</b>		<b>17,537</b>	<b>22,932</b>	<b>34,106</b>
Financial expenses		(2,198)	(2,060)	(1,050)
Financial income		709	529	81
Net finance costs	23	(1,489)	(1,531)	(969)
<b>Profit before taxation</b>		<b>16,048</b>	<b>21,401</b>	<b>33,137</b>
Income tax expense		(6,015)	(6,691)	(10,430)
Royalty-related taxation (net of income tax benefit)		(432)	(386)	(307)
Total taxation expense	6	(6,447)	(7,077)	(10,737)
<b>Profit after taxation from Continuing operations</b>		<b>9,601</b>	<b>14,324</b>	<b>22,400</b>
<b>Discontinued operations</b>				
Profit/(loss) after taxation from Discontinued operations	28	–	–	10,655
<b>Profit after taxation from Continuing and Discontinued operations</b>		<b>9,601</b>	<b>14,324</b>	<b>33,055</b>
Attributable to non-controlling interests		1,704	1,403	2,155
Attributable to BHP shareholders		7,897	12,921	30,900
Basic earnings per ordinary share (cents)	7	155.8	255.2	610.6
Diluted earnings per ordinary share (cents)	7	155.5	254.7	609.3
Basic earnings from Continuing operations per ordinary share (cents)	7	155.8	255.2	400.0
Diluted earnings from Continuing operations per ordinary share (cents)	7	155.5	254.7	399.2

The accompanying notes form part of these Financial Statements.

For persons



## 1.2 Consolidated Statement of Comprehensive Income for the year ended 30 June 2024

	Notes	<u>2024</u> US\$M	<u>2023</u> US\$M	<u>2022</u> US\$M
<b>Profit after taxation from Continuing and Discontinued operations</b>		<b>9,601</b>	14,324	33,055
<b>Other comprehensive income</b>				
<b>Items that may be reclassified subsequently to the income statement:</b>				
Hedges:				
(Losses)/gains taken to equity		(33)	95	(914)
Losses/(gains) transferred to the income statement		49	(148)	881
Loss transferred to initial carrying amount of hedged item		–	35	–
Exchange fluctuations on translation of foreign operations taken to equity		–	–	(5)
Exchange fluctuations on translation of foreign operations transferred to income statement		–	–	(54)
Tax recognised within other comprehensive income	6	(5)	5	10
<b>Total items that may be reclassified subsequently to the income statement</b>		<b>11</b>	<b>(13)</b>	<b>(82)</b>
<b>Items that will not be reclassified to the income statement:</b>				
Re-measurement gains/(losses) on pension and medical schemes		41	(18)	24
Equity investments held at fair value		(30)	17	(8)
Tax recognised within other comprehensive income	6	(13)	7	(9)
<b>Total items that will not be reclassified to the income statement</b>		<b>(2)</b>	<b>6</b>	<b>7</b>
<b>Total other comprehensive income/(loss)</b>		<b>9</b>	<b>(7)</b>	<b>(75)</b>
<b>Total comprehensive income</b>		<b>9,610</b>	14,317	32,980
Attributable to non-controlling interests		1,708	1,400	2,160
Attributable to BHP shareholders		<b>7,902</b>	12,917	30,820

The accompanying notes form part of these Financial Statements.

For personal use

### 1.3 Consolidated Balance Sheet as at 30 June 2024

	Notes	2024 US\$M	2023 US\$M
<b>ASSETS</b>			
<b>Current assets</b>			
Cash and cash equivalents	21	12,501	12,428
Trade and other receivables	8	5,169	4,594
Other financial assets	24	381	470
Inventories	10	5,828	5,220
Current tax assets		314	508
Other		145	131
<b>Total current assets</b>		<b>24,338</b>	<b>23,351</b>
<b>Non-current assets</b>			
Trade and other receivables	8	170	148
Other financial assets	24	1,229	1,115
Inventories	10	1,211	1,403
Property, plant and equipment	11	71,629	71,818
Intangible assets	12	1,718	1,610
Investments accounted for using the equity method	31	1,662	1,620
Deferred tax assets	14	67	56
Other		338	175
<b>Total non-current assets</b>		<b>78,024</b>	<b>77,945</b>
<b>Total assets</b>		<b>102,362</b>	<b>101,296</b>
<b>LIABILITIES</b>			
<b>Current liabilities</b>			
Trade and other payables	9	6,719	6,296
Interest bearing liabilities	21	2,084	7,173
Other financial liabilities	24	512	402
Current tax payable		884	611
Provisions	4,15,20,27	4,007	4,514
Deferred income		90	47
<b>Total current liabilities</b>		<b>14,296</b>	<b>19,043</b>
<b>Non-current liabilities</b>			
Trade and other payables	9	45	4
Interest bearing liabilities	21	18,634	15,172
Other financial liabilities	24	1,759	2,157
Non-current tax payable		40	68
Deferred tax liabilities	14	3,332	4,299
Provisions	4,15,20,27	15,088	11,973
Deferred income		48	50
<b>Total non-current liabilities</b>		<b>38,946</b>	<b>33,723</b>
<b>Total liabilities</b>		<b>53,242</b>	<b>52,766</b>
<b>Net assets</b>		<b>49,120</b>	<b>48,530</b>
<b>EQUITY</b>			
Share capital	17	4,899	4,737
Treasury shares	17	(36)	(41)
Reserves	18	(15)	13
Retained earnings		39,963	39,787
<b>Total equity attributable to BHP shareholders</b>		<b>44,811</b>	<b>44,496</b>
Non-controlling interests	18	4,309	4,034
<b>Total equity</b>		<b>49,120</b>	<b>48,530</b>

The accompanying notes form part of these Financial Statements.

The Financial Statements were approved by the Board of Directors on 27 August 2024 and signed on its behalf by:

**Ken MacKenzie**  
Chair

**Mike Henry**  
Chief Executive Officer

#### 1.4 Consolidated Cash Flow Statement for the year ended 30 June 2024

	Notes	2024 US\$M	2023 US\$M	2022 US\$M
<b>Operating activities</b>				
Profit before taxation from Continuing operations		16,048	21,401	33,137
Adjustments for:				
Depreciation and amortisation expense		5,295	5,061	5,683
Impairments of property, plant and equipment, financial assets and intangibles		3,890	75	515
Net finance costs		1,489	1,531	969
Loss/(profit) from equity accounted investments, related impairments and expenses		2,656	(594)	19
Other		(243)	546	(350)
Changes in assets and liabilities:				
Trade and other receivables		(290)	867	(703)
Inventories		(530)	(44)	(865)
Trade and other payables		(27)	(1,086)	727
Provisions and other assets and liabilities		(469)	131	(248)
Cash generated from operations		27,819	27,888	38,884
Dividends received		397	347	1,018
Interest received		724	545	58
Interest paid		(1,680)	(1,090)	(657)
Proceeds of cash management related instruments		361	331	378
Net income tax and royalty-related taxation refunded		547	232	105
Net income tax and royalty-related taxation paid		(7,503)	(9,552)	(10,501)
<b>Net operating cash flows from Continuing operations</b>		<b>20,665</b>	<b>18,701</b>	<b>29,285</b>
Net operating cash flows from Discontinued operations	28	–	–	2,889
<b>Net operating cash flows</b>		<b>20,665</b>	<b>18,701</b>	<b>32,174</b>
<b>Investing activities</b>				
Purchases of property, plant and equipment		(8,816)	(6,733)	(5,855)
Exploration and evaluation expenditure		(457)	(350)	(256)
Exploration and evaluation expenditure expensed and included in operating cash flows		399	294	199
Investment in subsidiaries, operations and joint operations, net of cash	29	–	(5,868)	–
Net investment and funding of equity accounted investments		(701)	(557)	(266)
Proceeds from sale of assets		149	444	221
Proceeds from sale of subsidiaries, operations and joint operations net of their cash		1,072	82	1,255
Other investing		(408)	(377)	(271)
<b>Net investing cash flows from Continuing operations</b>		<b>(8,762)</b>	<b>(13,065)</b>	<b>(4,973)</b>
Net investing cash flows from Discontinued operations	28	–	–	(904)
Net cash completion payment on merger of Petroleum with Woodside	28	–	–	(683)
Cash and cash equivalents disposed on merger of Petroleum with Woodside	28	–	–	(399)
<b>Net investing cash flows</b>		<b>(8,762)</b>	<b>(13,065)</b>	<b>(6,959)</b>
<b>Financing activities</b>				
Proceeds from interest bearing liabilities		5,091	8,182	1,164
Settlements of debt related instruments		(321)	(677)	–
Repayment of interest bearing liabilities		(7,327)	(3,289)	(3,358)
Distributions to non-controlling interests		(13)	–	–
Purchase of shares by Employee Share Ownership Plan (ESOP) Trusts		–	(88)	(149)
Dividends paid		(7,675)	(13,268)	(17,851)
Dividends paid to non-controlling interests		(1,424)	(1,175)	(2,540)
<b>Net financing cash flows from Continuing operations</b>		<b>(11,669)</b>	<b>(10,315)</b>	<b>(22,734)</b>
Net financing cash flows from Discontinued operations	28	–	–	(33)
<b>Net financing cash flows</b>		<b>(11,669)</b>	<b>(10,315)</b>	<b>(22,767)</b>
<b>Net increase/(decrease) in cash and cash equivalents from Continuing operations</b>		<b>234</b>	<b>(4,679)</b>	<b>1,578</b>
<b>Net increase in cash and cash equivalents from Discontinued operations</b>		<b>–</b>	<b>–</b>	<b>1,952</b>
Net cash completion payment on merger of Petroleum with Woodside		–	–	(683)
Cash and cash equivalents disposed on merger of Petroleum with Woodside		–	–	(399)
Cash and cash equivalents, net of overdrafts, at the beginning of the financial year		12,423	17,236	15,246
Foreign currency exchange rate changes on cash and cash equivalents		(159)	(134)	(458)
<b>Cash and cash equivalents, net of overdrafts, at the end of the financial year</b>	21	<b>12,498</b>	<b>12,423</b>	<b>17,236</b>

The accompanying notes form part of these Financial Statements.

## 1.5 Consolidated Statement of Changes in Equity for the year ended 30 June 2024

US\$M	Attributable to BHP shareholders						
	BHP Group Limited				Total equity attributable to BHP shareholders	Non-controlling interests	Total equity
	Share capital	Treasury shares	Reserves	Retained earnings			
Balance as at 1 July 2023	4,737	(41)	13	39,787	44,496	4,034	48,530
Total comprehensive income	-	-	(18)	7,920	7,902	1,708	9,610
Transactions with owners:							
Shares issued	162	(162)	-	-	-	-	-
Purchase of shares by ESOP Trusts	-	-	-	-	-	-	-
Employee share awards exercised net of employee contributions net of tax	-	167	(134)	(33)	-	-	-
Vested employee share awards that have lapsed, been cancelled or forfeited	-	-	(1)	1	-	-	-
Accrued employee entitlement for unexercised awards net of tax	-	-	129	-	129	-	129
Dividends	-	-	-	(7,712)	(7,712)	(1,424)	(9,136)
Distribution to non-controlling interests	-	-	(4)	-	(4)	(9)	(13)
Balance as at 30 June 2024	4,899	(36)	(15)	39,963	44,811	4,309	49,120
Balance as at 1 July 2022	4,638	(31)	12	40,338	44,957	3,809	48,766
Total comprehensive income	-	-	4	12,913	12,917	1,400	14,317
Transactions with owners:							
Shares issued	99	(99)	-	-	-	-	-
Purchase of shares by ESOP Trusts	-	(88)	-	-	(88)	-	(88)
Employee share awards exercised net of employee contributions net of tax	-	177	(132)	(45)	-	-	-
Vested employee share awards that have lapsed, been cancelled or forfeited	-	-	(1)	1	-	-	-
Accrued employee entitlement for unexercised awards net of tax	-	-	130	-	130	-	130
Dividends	-	-	-	(13,420)	(13,420)	(1,175)	(14,595)
Balance as at 30 June 2023	4,737	(41)	13	39,787	44,496	4,034	48,530

US\$M	Attributable to BHP shareholders								
	Share capital		Treasury shares		Reserves	Retained earnings	Total equity attributable to BHP shareholders	Non-controlling interests	Total equity
	BHP Group Limited	BHP Group Plc	BHP Group Limited	BHP Group Plc					
Balance as at 1 July 2021	1,111	1,057	(32)	(1)	2,350	46,779	51,264	4,341	55,605
Total comprehensive income	-	-	-	-	(90)	30,910	30,820	2,160	32,980
Transactions with owners:									
BHP Group Limited shares issued	172	-	(172)	-	-	-	-	-	-
Purchase of shares by ESOP Trusts	-	-	(148)	(1)	-	-	(149)	-	(149)
Employee share awards exercised net of employee contributions net of tax	-	-	321	2	(207)	(116)	-	-	-
Vested employee share awards that have lapsed, been cancelled or forfeited	-	-	-	-	(30)	30	-	-	-
Accrued employee entitlement for unexercised awards net of tax	-	-	-	-	143	-	143	-	143
Corporate structure unification	3,355	(1,057)	-	-	(2,298)	-	-	-	-
Dividends	-	-	-	-	-	(17,720)	(17,720)	(2,540)	(20,260)
In specie dividend on merger of Petroleum with Woodside	-	-	-	-	-	(19,559)	(19,559)	-	(19,559)
Divestment of subsidiaries, operations and joint operations	-	-	-	-	-	-	-	(157)	(157)
Transfers within equity on divestment of subsidiaries, operations and joint operations	-	-	-	-	(14)	14	-	-	-
Equity contributed net of tax	-	-	-	-	158	-	158	5	163
Balance as at 30 June 2022	4,638	-	(31)	-	12	40,338	44,957	3,809	48,766

The accompanying notes form part of these Financial Statements.

## Basis of preparation

The Consolidated Financial Statements (Financial Statements) comprise BHP Group Limited (BHP or the Company) together with its controlled entities (Group) for the year ended 30 June 2024. BHP Group Limited, incorporated and domiciled in Australia, is a for-profit company limited by shares which are publicly traded on the Australian Securities Exchange. BHP Group Limited also has an international secondary listing on the London Stock Exchange (LSE), a secondary listing on the Johannesburg Stock Exchange and is listed on the New York Stock Exchange (NYSE) in the United States.

Prior to 31 January 2022, BHP Group Limited and BHP Group Plc, an incorporated UK-listed company, operated together as a single-for-profit economic entity under a Dual Listed Company (DLC) structure comprising a common Board of Directors, unified management structure and joint objectives. On 31 January 2022, BHP unified its corporate structure under BHP Group Limited.

Directors of BHP have included information in the Financial Statements they deem to be material and relevant to the understanding of the Financial Statements. Disclosure may be considered material and relevant if the dollar amount is significant due to its size or nature, or the information is important to understand the:

- Group's current year results
- impact of significant changes in the Group's business or
- aspects of the Group's operations that are important to future performance

The Board of Directors resolved to authorise the issue of the financial report on 27 August 2024.

## Basis of preparation and measurement

The Group's Financial Statements as at and for the year ended 30 June 2024:

- are a consolidated general purpose financial report
- have been prepared in accordance with the requirements of:
  - the Australian Corporations Act 2001 (Corporations Act 2001)
  - Australian Accounting Standards and other authoritative pronouncements of the Australian Accounting Standards Board (AASB) and International Financial Reporting Standards as issued by the International Accounting Standards Board (IASB) (collectively referred to as IFRS)
- are prepared on a going concern basis as the Directors:
  - have made an assessment of the Group's ability to continue as a going concern for the 12 months from the date of this report
  - consider it appropriate to adopt the going concern basis of accounting in preparing the Group's Financial Statements
- measure items on the basis of historical cost principles, except for the following items:
  - derivative financial instruments and certain other financial assets and liabilities, which are carried at fair value
  - non-current assets or disposal groups that are classified as held-for-sale or held-for-distribution, which are measured at the lower of carrying amount and fair value less costs to sell
- include material accounting policies in the notes to the Financial Statements, specifically where accounting policy choices have been made in relation to the recognition and measurement basis used and are relevant to an understanding of the Financial Statements
- apply a presentation currency of US dollars, consistent with the predominant functional currency of the Group's operations. Amounts are rounded to the nearest million dollars, unless otherwise stated, in accordance with ASIC (Rounding in Financial/Directors' Reports) Instrument 2016/191
- present reclassified comparative information where required for consistency with the current year's presentation
- adopt all new and amended standards and interpretations under IFRS that are mandatory for application in periods beginning on 1 July 2023. None had a significant impact on the Financial Statements. Refer note 39 'New and amended accounting standards and interpretations and changes to accounting policies' for details
- have not early adopted any standards and interpretations that have been issued or amended but are not yet effective, other than as outlined in note 39 'New and amended accounting standards and interpretations and changes to accounting policies'

The accounting policies are consistently applied by all entities included in the Financial Statements.

In assessing the appropriateness of the going concern assumption over the going concern period, management has stress tested BHP's most recent financial projections to incorporate a range of potential future outcomes by considering BHP's principal risks. The Group's financial forecasts, including downside commodity price and production scenarios, demonstrate that the Group believes that it has sufficient financial resources to meet its obligations as they fall due throughout the going concern period. As such, the Financial Statements continue to be prepared on the going concern basis.

## Principles of consolidation

A list of significant entities in the Group, including subsidiaries, joint arrangements and associates at 30 June 2024 is contained in note 30 'Subsidiaries', note 31 'Investments accounted for using the equity method' and note 32 'Interests in joint operations'.

**Subsidiaries:** The Financial Statements of the Group include the consolidation of BHP Group Limited (the Company or parent entity) and its subsidiaries, being the entities controlled by the parent entity during the year (and prior to 31 January 2022, BHP Group Plc and its subsidiaries while the DLC was in effect). Control exists where the Group:

- has power over the investee
- is exposed to, or has rights to, variable returns from its involvement with the entity
- has the ability to affect those returns through its power to direct the activities of the entity

The ability to approve the operating and capital budget of an entity and the ability to appoint key management personnel are decisions that demonstrate that the Group has the existing rights to direct the relevant activities of an entity.

The results of subsidiaries acquired or disposed of during the year are included in profit or loss from the date the Company gains control until the date when the Company ceases to control the subsidiary. When the Group loses control of a subsidiary, the gain or loss on disposal is recognised in profit or loss.

Where the Group's interest is less than 100 per cent, the interest attributable to outside shareholders is reflected in non-controlling interests.

Changes in the Group's interests in subsidiaries that do not result in a loss of control are accounted for as equity transactions. The carrying amount of the Group's interests and the non-controlling interests are adjusted to reflect the changes in their relative interests in the subsidiaries. Any difference between the amount by which the non-controlling interests are adjusted and the fair value of the consideration paid or received is recognised directly in equity and attributed to the owners of the Company.

The financial information of subsidiaries is prepared for the same reporting period as the Group. The acquisition method of accounting is used to account for the Group's business combinations.

**Joint arrangements:** The Group undertakes a number of business activities through joint arrangements, which exist when two or more parties have joint control. Joint arrangements are classified as either joint operations or joint ventures, based on the contractual rights and obligations between the parties to the arrangement:

- **Joint operations:** A joint operation is an arrangement in which the Group shares joint control, primarily via contractual arrangements with other parties. In a joint operation, the Group has rights to the underlying assets and obligations for the liabilities relating to the arrangement. This includes situations where the parties benefit from the joint activity through a share of the output, rather than by receiving a share of the results of trading. In relation to the Group's interest in a joint operation, the Group recognises: its assets and liabilities, including its share of any assets and liabilities held or incurred jointly; revenue from the sale of its share of the output and its share of any revenue generated from the sale of the output by the joint operation; and its expenses including its share of expenses incurred jointly. All such amounts are allocated in accordance with the terms of the arrangement, which is usually in proportion to the Group's interest in the joint operation.

The Group accounts for the assets, liabilities, revenue and expenses relating to its interest in a joint operation in accordance with the IFRS Standards applicable to the particular assets, liabilities, revenue and expenses.

- **Joint ventures:** A joint venture is a joint arrangement in which the parties that share joint control have rights to the net assets of the arrangement. A separate vehicle, not the parties, will have the rights to the assets and obligations for the liabilities relating to the arrangement. More than an insignificant share of output from a joint venture is sold to third parties, which indicates the joint venture is not dependent on the parties to the arrangement for funding, nor do the parties have an obligation for the liabilities of the arrangement. Joint ventures are accounted for using the equity method as outlined below.

**Associates:** The Group accounts for investments in associates using the equity method as outlined below. An entity is considered an associate where the Group is deemed to have significant influence but not control or joint control. Significant influence is presumed to exist where the Group:

- has over 20 per cent but less than 50 per cent of the voting rights of an entity, unless it can be clearly demonstrated that this is not the case or
- holds less than 20 per cent of the voting rights of an entity; however, has the power to participate in the financial and operating policy decisions affecting the entity

The Group uses the term 'equity accounted investments' to refer to joint ventures and associates collectively.

Under the equity method, an investment in an associate or a joint venture is recognised initially at cost and adjusted thereafter to recognise the Group's share of the profit or loss and other comprehensive income of the associate or joint venture. When the Group's share of losses of an associate or a joint venture exceeds the Group's interest in that associate or joint venture, the Group discontinues recognising its share of further losses. Additional losses are recognised only to the extent that the Group has incurred legal or constructive obligations or made payments on behalf of the associate or joint venture.

#### **Foreign currencies**

Transactions related to the Group's worldwide operations are conducted in a number of foreign currencies. The majority of the subsidiaries, joint arrangements and associates within each of the operations have assessed US dollars as the functional currency. Subsidiaries, joint arrangements and associates that have functional currencies other than US dollars are not material to the financial performance or the financial position of the Group.

Foreign exchange gains and losses are recognised in the income statement, except for qualifying cash flow hedges (which are deferred to equity) and foreign exchange gains or losses on foreign currency provisions for site closure and rehabilitation costs (which are capitalised in property, plant and equipment for operating sites).

### Significant judgements and estimates

The Group's accounting policies require the use of judgement, estimates and assumptions. All judgements, estimates and assumptions are based on the most current facts and circumstances and are reassessed on an ongoing basis. Actual results in future reporting periods may differ for these estimates under different assumptions and conditions.

Further information regarding the Group's significant judgements and key estimates and assumptions, being those where changes may materially affect financial results and the carrying amount of assets and liabilities to be reported in the next reporting period, are embedded within the following notes:

#### Note

4	Significant events – Samarco dam failure
6	Taxation
11	Overburden removal costs
11	Depreciation of property, plant and equipment
13	Impairment of non-current assets
15	Closure and rehabilitation provisions
22	Leases
29	Business combinations

Additional information including sensitivity analysis, where appropriate, has been provided in the relevant notes to enhance an understanding of the impact of key estimates and assumptions on the Group's financial position and performance.

### Reserve estimates

Estimates are used in the determination of stripping ratios and mineral reserves by component. For purposes of the Group's Financial Statements, reserves estimates are based on internally generated, projected long-term commodity prices and current operating costs used in studies for development projects. In order to estimate reserves, assumptions are required about a range of technical and economic factors, including quantities, qualities, production techniques, recovery efficiency, production and transport costs, commodity supply and demand, commodity and carbon prices and exchange rates.

Estimating the quantity and/or quality of reserves requires the size, shape and depth of ore bodies to be determined by analysing geological data, such as drilling samples and geophysical survey interpretations. Economic assumptions used to estimate reserves change from period-to-period as additional technical and operational data is generated. This process may require complex and difficult geological judgements to interpret the data.

#### *Reserve impact on financial reporting*

Estimates of reserves may change from period-to-period as the economic assumptions used to estimate reserves change and additional geological data is generated during the course of operations. Changes in reserves may affect the Group's financial results and financial position in a number of ways, including:

- asset carrying values may be affected due to changes in estimated future production levels
- depreciation, depletion and amortisation charged to the income statement may change where such charges are determined on the units of production basis, or where the useful economic lives of assets change
- overburden removal costs recorded on the balance sheet or charged to the income statement may change due to changes in stripping ratios or the units of production basis of depreciation
- closure and rehabilitation provisions may change where changes in estimated reserves affect expectations about the timing or cost of these activities
- the carrying amount of deferred tax assets may change due to changes in estimates of the likely recovery of the tax benefits

## 1.6 Notes to the Financial Statements

### Performance

#### 1 Segment reporting

##### Reportable segments

The Group operated three reportable segments during FY2024, which are aligned with the commodities that are extracted and marketed and reflect the structure used by the Group's management to assess the performance of the Group.

Reportable segment	Principal activities
Copper	Mining of copper, uranium, gold, zinc, molybdenum and silver
Iron Ore	Mining of iron ore
Coal	Mining of steelmaking coal and energy coal

Group and unallocated items includes functions, other unallocated operations including Potash, Western Australia Nickel (which comprises the Nickel West operations and, following the OZ Minerals Ltd (OZL) acquisition on 2 May 2023, the West Musgrave project), legacy assets and consolidation adjustments. Revenue not attributable to reportable segments comprises the sale of freight and fuel to third parties, as well as revenues from unallocated operations. Exploration and technology activities are recognised within relevant segments.

Year ended 30 June 2024				Group and unallocated items/ eliminations	Group total
US\$M	Copper	Iron Ore	Coal		
Revenue	18,566	27,952	7,666	1,474	55,658
Inter-segment revenue	–	–	–	–	–
<b>Total revenue</b>	<b>18,566</b>	<b>27,952</b>	<b>7,666</b>	<b>1,474</b>	<b>55,658</b>
<b>Underlying EBITDA</b>	<b>8,564</b>	<b>18,913</b>	<b>2,290</b>	<b>(751)</b>	<b>29,016</b>
Depreciation and amortisation	(2,023)	(2,027)	(611)	(634)	(5,295)
Impairment losses <sup>1</sup>	(17)	(61)	(2)	(10)	(90)
<b>Underlying EBIT</b>	<b>6,524</b>	<b>16,825</b>	<b>1,677</b>	<b>(1,395)</b>	<b>23,631</b>
Exceptional items <sup>2</sup>	–	(3,066)	880	(3,908)	(6,094)
Net finance costs					(1,489)
<b>Profit before taxation</b>					<b>16,048</b>
<b>Capital expenditure (cash basis)</b>	<b>3,711</b>	<b>2,033</b>	<b>646</b>	<b>2,426</b>	<b>8,816</b>
<b>(Loss)/profit from equity accounted investments, related impairments and expenses</b>	<b>377</b>	<b>(3,032)</b>	<b>–</b>	<b>(1)</b>	<b>(2,656)</b>
<b>Investments accounted for using the equity method</b>	<b>1,573</b>	<b>–</b>	<b>–</b>	<b>89</b>	<b>1,662</b>
<b>Total assets</b>	<b>42,145</b>	<b>25,569</b>	<b>9,528</b>	<b>25,120</b>	<b>102,362</b>
<b>Total liabilities</b>	<b>5,777</b>	<b>11,757</b>	<b>3,056</b>	<b>32,652</b>	<b>53,242</b>



Year ended 30 June 2023				Group and unallocated items/ eliminations	Group total
US\$M	Copper	Iron Ore	Coal		
Revenue	16,027	24,812	10,958	2,020	53,817
Inter-segment revenue	–	–	–	–	–
<b>Total revenue</b>	<b>16,027</b>	<b>24,812</b>	<b>10,958</b>	<b>2,020</b>	<b>53,817</b>
Underlying EBITDA	6,653	16,692	4,998	(387)	27,956
Depreciation and amortisation	(1,810)	(1,993)	(697)	(561)	(5,061)
Impairment losses <sup>1</sup>	(33)	(28)	(6)	(8)	(75)
<b>Underlying EBIT</b>	<b>4,810</b>	<b>14,671</b>	<b>4,295</b>	<b>(956)</b>	<b>22,820</b>
Exceptional items <sup>2</sup>	–	176	–	(64)	112
<b>Net finance costs</b>					<b>(1,531)</b>
<b>Profit before taxation</b>					<b>21,401</b>
Capital expenditure (cash basis)	2,698	1,966	657	1,412	6,733
(Loss)/profit from equity accounted investments, related impairments and expenses	383	215	–	(4)	594
Investments accounted for using the equity method	1,530	–	–	90	1,620
<b>Total assets</b>	<b>39,864</b>	<b>25,527</b>	<b>11,087</b>	<b>24,818</b>	<b>101,296</b>
<b>Total liabilities</b>	<b>5,635</b>	<b>8,571</b>	<b>3,821</b>	<b>34,739</b>	<b>52,766</b>

Year ended 30 June 2022				Group and unallocated items/ eliminations	Group total
US\$M	Copper	Iron Ore	Coal		
Revenue	16,849	30,767	15,549	1,933	65,098
Inter-segment revenue	–	–	–	–	–
<b>Total revenue</b>	<b>16,849</b>	<b>30,767</b>	<b>15,549</b>	<b>1,933</b>	<b>65,098</b>
Underlying EBITDA	8,565	21,707	9,504	858	40,634
Depreciation and amortisation	(1,765)	(2,203)	(762)	(953)	(5,683)
Impairment losses <sup>1</sup>	(470)	(33)	(9)	(3)	(515)
<b>Underlying EBIT</b>	<b>6,330</b>	<b>19,471</b>	<b>8,733</b>	<b>(98)</b>	<b>34,436</b>
Exceptional items <sup>2</sup>	–	(729)	849	(450)	(330)
<b>Net finance costs</b>					<b>(969)</b>
<b>Profit before taxation</b>					<b>33,137</b>
Capital expenditure (cash basis)	2,528	1,848	621	858	5,855
(Loss)/profit from equity accounted investments, related impairments and expenses	658	(676)	–	(1)	(19)
Investments accounted for using the equity method	1,415	–	–	5	1,420
<b>Total assets</b>	<b>32,693</b>	<b>24,682</b>	<b>11,524</b>	<b>26,267</b>	<b>95,166</b>
<b>Total liabilities</b>	<b>5,248</b>	<b>7,884</b>	<b>3,874</b>	<b>29,394</b>	<b>46,400</b>

<sup>1</sup> Impairment losses exclude exceptional items of US\$3,800 million (2023: US\$ nil; 2022: US\$ nil).

<sup>2</sup> Exceptional items reported in Group and unallocated include Samarco dam failure related costs of US\$(105) million (2023: US\$(64) million; 2022: US\$(13) million). Refer to note 3 'Exceptional items' for further information.

## Geographical information

	Revenue by location of customer		
	2024	2023	2022
	US\$M	US\$M	US\$M
Australia	2,393	1,702	1,649
Europe	1,702	1,961	2,129
China	34,752	31,205	36,618
Japan	4,557	6,971	8,401
India	3,371	3,447	5,215
South Korea	3,069	2,997	4,786
Rest of Asia	3,749	3,583	4,303
North America	1,601	1,382	1,282
South America	464	569	715
	<b>55,658</b>	<b>53,817</b>	<b>65,098</b>

	Non-current assets by location of assets		
	2024	2023	2022
	US\$M	US\$M	US\$M
Australia	48,991	51,961	43,250
North America	6,979	5,081	3,964
South America	19,927	19,047	18,280
Rest of world	831	685	150
Unallocated assets <sup>1</sup>	1,296	1,171	858
	<b>78,024</b>	<b>77,945</b>	<b>66,502</b>

<sup>1</sup> Unallocated assets comprise deferred tax assets and other financial assets.

### Underlying EBITDA

Underlying EBITDA is earnings before net finance costs, depreciation, amortisation and impairments, taxation expense, Discontinued operations and any exceptional items. Underlying EBITDA includes BHP's share of profit/(loss) from investments accounted for using the equity method including net finance costs, depreciation, amortisation and impairments and taxation expense/(benefit).

Exceptional items are excluded from Underlying EBITDA in order to enhance the comparability of such measures from period-to-period and provide investors with further clarity in order to assess the performance of the Group's operations. Management monitors exceptional items separately. Refer to note 3 'Exceptional items' for additional detail.

### Segment assets and liabilities

Total segment assets and liabilities of reportable segments represents operating assets and operating liabilities, including the carrying amount of equity accounted investments and predominantly excludes cash balances, loans to associates, interest bearing liabilities and deferred tax balances. The carrying value of investments accounted for using the equity method represents the balance of the Group's investment in equity accounted investments, with no adjustment for any cash balances, interest bearing liabilities or deferred tax balances of the equity accounted investment.

## 2 Revenue

### Revenue by segment and asset

	2024	2023	2022
	US\$M	US\$M	US\$M
Escondida	10,013	8,847	9,500
Pampa Norte	2,375	2,491	2,670
Copper South Australia <sup>1</sup>	4,085	2,806	1,776
Third-party products	2,021	1,863	2,903
Other	72	20	–
<b>Total Copper<sup>2</sup></b>	<b>18,566</b>	<b>16,027</b>	<b>16,849</b>
Western Australia Iron Ore	27,805	24,678	30,632
Third-party products	25	21	19
Other	122	113	116
<b>Total Iron Ore</b>	<b>27,952</b>	<b>24,812</b>	<b>30,767</b>
BHP Mitsubishi Alliance	5,873	7,652	10,254
New South Wales Energy Coal	1,793	3,306	3,035
Other <sup>3</sup>	–	–	2,260
<b>Total Coal<sup>4</sup></b>	<b>7,666</b>	<b>10,958</b>	<b>15,549</b>
Group and unallocated items <sup>5</sup>	1,474	2,020	1,933
Inter-segment adjustment	–	–	–
<b>Total revenue</b>	<b>55,658</b>	<b>53,817</b>	<b>65,098</b>

<sup>1</sup> Includes Olympic Dam as well as Prominent Hill and Carrapateena since acquisition on 2 May 2023.

<sup>2</sup> Total Copper revenue includes: copper US\$17,229 million (2023: US\$14,902 million; 2022: US\$15,992 million) and other US\$1,337 million (2023: US\$1,125 million; 2022: US\$857 million). Other consists of direct sales of uranium, gold, zinc, molybdenum and silver.

<sup>3</sup> FY2022 includes revenue related to BHP Mitsui Coal (BMC) divested in May 2022.

<sup>4</sup> Total Coal revenue includes: steelmaking coal US\$5,793 million (2023: US\$7,430 million; 2022: US\$11,990 million) and energy coal US\$1,873 million (2023: US\$3,528 million; 2022: US\$3,559 million).

<sup>5</sup> Group and unallocated items revenue includes: Western Australia Nickel US\$1,473 million (2023: US\$2,009 million; 2022: US\$1,926 million) and other revenue US\$1 million (2023: US\$11 million; 2022: US\$7 million).

Revenue consists of revenue from contracts with customers of US\$55,375 million (2023: US\$53,910 million; 2022: US\$65,504 million) and other revenue predominantly relating to provisionally priced sales of US\$283 million (2023: US\$(93) million; 2022: US\$(406) million).

### Recognition and measurement

The Group generates revenue from the production and sale of commodities. Revenue is recognised when or as control of the promised goods or services passes to the customer. In most instances, control passes when the goods are delivered to a destination specified by the customer, typically on board the customer's appointed vessel. Revenue from the provision of services is recognised over time as the services are provided, but does not represent a significant proportion of total revenue and is aggregated with the respective asset and product revenue for disclosure purposes.

The amount of revenue recognised reflects the consideration to which the Group expects to be entitled in exchange for transferring goods or services.

Where the Group's sales are provisionally priced, the final price depends on future index prices. The amount of revenue initially recognised is based on the relevant forward market price. Adjustments between the provisional and final price are accounted for under IFRS 9/AASB 9 'Financial Instruments' (IFRS 9), separately recorded as other revenue and presented as part of the total revenue of each asset. The period between provisional pricing and final invoicing is typically between 60 and 120 days.

Revenue from the sale of significant by-products is included within revenue.

The Group applies the following practical expedients:

- expected consideration is not adjusted for the effects of the time value of money if the period between the delivery and when the customer pays for the promised good or service is one year or less
- no disclosure is provided for information relating to unfulfilled performance obligations, either due to the expected duration of the contract term being one year or less, or for longer term contracts, because the entity has a right to consideration (and can recognise revenue) for goods delivered

### 3 Exceptional items

Exceptional items are those gains or losses where their nature, including the expected frequency of the events giving rise to them, and impact is considered material to the Financial Statements. Such items included within the Group's profit from Continuing operations for the year are detailed below. Exceptional items attributable to Discontinued operations are detailed in note 28 'Discontinued operations'.

Year ended 30 June 2024	Gross US\$M	Tax US\$M	Net US\$M
<b>Exceptional items by category</b>			
Samarco dam failure	(3,677)	(85)	(3,762)
Impairment of Western Australia Nickel assets	(3,800)	1,125	(2,675)
Blackwater and Daunia gain on divestment	877	(203)	674
<b>Total</b>	<b>(6,600)</b>	<b>837</b>	<b>(5,763)</b>
Attributable to non-controlling interests	-	-	-
Attributable to BHP shareholders	(6,600)	837	(5,763)

#### Samarco Mineração S.A. (Samarco) dam failure

The loss of US\$3,762 million (after tax) relates to the Samarco dam failure, which occurred in November 2015, and comprises the following:

Year ended 30 June 2024	US\$M
Expenses excluding net finance costs:	
Costs incurred directly by BHP Brasil and other BHP entities in relation to the Samarco dam failure	(139)
(Loss)/profit from equity accounted investments, related impairments and expenses:	
Samarco dam failure provision	(2,833)
Fair value change on forward exchange derivatives	(199)
Net finance costs	(506)
Income tax expense	(85)
<b>Total<sup>1</sup></b>	<b>(3,762)</b>

<sup>1</sup> Refer to note 4 'Significant events – Samarco dam failure' for further information.

#### Western Australia Nickel impairment

The Group recognised an impairment charge of US\$2,675 million (after tax) in relation to the Western Australia Nickel assets. The impairment charge reflects the oversupply in the global nickel market that has seen a sharp decline in forward nickel prices in the short to medium term, escalation in capital costs for Western Australia Nickel, and changes to development plans including the Group's decision, announced on 11 July 2024, to temporarily suspend Nickel West operations and the West Musgrave project at Western Australia Nickel. Refer to note 13 'Impairment of non-current assets' for further information.

#### Blackwater and Daunia gain on divestment

On 2 April 2024 BHP and Mitsubishi Development Pty Ltd (MDP) completed the divestment of the Blackwater and Daunia mines (which were part of the BHP Mitsubishi Alliance (BMA)) to Whitehaven Coal. Each of BHP and MDP hold a 50% interest in BMA.

Whitehaven Coal paid a US\$100 million deposit on signing of the Asset Sale Agreement on 18 October 2023 and a further US\$2 billion cash on completion plus a preliminary completion adjustment of US\$44.1 million for working capital and other agreed adjustments (100% interest basis).

US\$1.1 billion in cash remains payable over 3 years after completion and a potential additional amount up to US\$0.9 billion in a price-linked earnout may also be payable over 3 years (100% interest basis). The price-linked earnout is subject to a cap of US\$350 million each year and depends on average realised pricing exceeding agreed thresholds for each of the 3 years following completion on 2 April 2024.

The total cash consideration for the transaction could be up to US\$4.1 billion plus the final completion adjustment amount (100% interest basis).

Details of the gain on divestment is as follows:

	US\$M
<b>Assets</b>	
Inventories	113
Property, plant and equipment	1,453
Intangible assets	45
Other	3
<b>Total assets</b>	<b>1,614</b>
<b>Liabilities</b>	
Interest bearing liabilities	60
Other financial liabilities	43
Provisions	691
<b>Total liabilities</b>	<b>794</b>
<b>Net assets disposed</b>	<b>820</b>
Cash consideration – BHP share	1,072
Deferred and contingent consideration <sup>1</sup>	690
Transaction and other directly attributable costs	(65)
Income tax expense	(203)
<b>Gain on divestment</b>	<b>674</b>

<sup>1</sup> Includes the fair value of contingent payments based on 35% revenue share to BMA, subject to average realised prices achieved by the Assets exceeding thresholds of US\$159/tonne in the 12 month period 12 months post completion, US\$134/tonne in the 12 month period 24 months post completion and US\$134/tonne in the 12 month period 36 months post completion.

The exceptional items relating to the years ended 30 June 2023 and 30 June 2022 are detailed below.

### 30 June 2023

Year ended 30 June 2023	Gross US\$M	Tax US\$M	Net US\$M
<b>Exceptional items by category</b>			
Samarco dam failure	(340)	17	(323)
Chilean tax reform	–	(283)	(283)
Total	(340)	(266)	(606)
Attributable to non-controlling interests	–	(107)	(107)
Attributable to BHP shareholders	(340)	(159)	(499)

### Samarco Mineração S.A. (Samarco) dam failure

The loss of US\$323 million (after tax) related to the Samarco dam failure, which occurred in November 2015, and comprised the following:

Year ended 30 June 2023	US\$M
<b>Expenses excluding net finance costs:</b>	
Costs incurred directly by BHP Brasil and other BHP entities in relation to the Samarco dam failure	(103)
<b>(Loss)/profit from equity accounted investments, related impairments and expenses:</b>	
Samarco dam failure provision	(256)
Fair value change on forward exchange derivatives	471
Net finance costs	(452)
Income tax benefit	17
<b>Total<sup>1</sup></b>	<b>(323)</b>

<sup>1</sup> Refer to note 4 'Significant events – Samarco dam failure' for further information.

### Chilean tax reform

On 17 May 2023, the Chilean Lower House approved a Royalty Bill which would implement a 1 per cent royalty on revenues, a margin based tax with rates ranging between 8 per cent and 26 per cent, and a 46.5 per cent cap to the overall Chilean tax burden of mining companies.

The President of the Lower House formally declared the legislative process complete on 12 June 2023, following receipt of the Chilean President's formal confirmation that he had waived his veto power to oppose any of the provisions of the Royalty Bill. On 13 July 2023, the Constitutional Court finalised its review of certain aspects of the Royalty Bill, relating only to the distribution of proceeds.

Applying judgement, it was determined that the proposed tax rates were substantively enacted prior to 30 June 2023, as the scope of the Constitutional Court review did not extend to reviewing the tax rates.

While the timing of when the Group's operations will be impacted by the reform depends on existing stability agreements, relevant deferred tax positions were remeasured by US\$283 million in the Group's FY2023 Financial Statements.

### 30 June 2022

Year ended 30 June 2022	Gross US\$M	Tax US\$M	Net US\$M
<b>Exceptional items by category</b>			
Samarco dam failure	(1,032)	(31)	(1,063)
Impairment of US deferred tax assets	–	(423)	(423)
Corporate structure unification costs	(428)	–	(428)
BHP Mitsui Coal (BMC) gain on disposal	840	–	840
Total	(620)	(454)	(1,074)
Attributable to non-controlling interests	–	–	–
Attributable to BHP shareholders	(620)	(454)	(1,074)

### Samarco Mineração S.A. (Samarco) dam failure

The loss of US\$1,063 million (after tax) related to the Samarco dam failure, which occurred in November 2015, and comprises the following:

Year ended 30 June 2022	US\$M
Expenses excluding net finance costs:	
Costs incurred directly by BHP Brasil and other BHP entities in relation to the Samarco dam failure	(66)
(Loss)/profit from equity accounted investments, related impairments and expenses:	
Samarco dam failure provision	(595)
Fair value change on forward exchange derivatives	(81)
Net finance costs	(290)
Income tax expense	(31)
Total	(1,063)

1 Refer to note 4 'Significant events – Samarco dam failure' for further information.

### Impairment of US deferred tax assets

The Group recognised an impairment charge of US\$423 million (after tax) in relation to deferred tax assets where the recoverability had historically been reliant on Petroleum earnings in the same tax group. While these tax assets remained with the Group following the merger of the Group's oil and gas portfolio with Woodside, the impairment charge reflected the extent of other forecasted future earnings against which the assets can be recovered.

### Corporate structure unification costs

The Group incurred transaction costs associated with the unification of the Group corporate structure under its existing Australian parent company, BHP Group Limited, which was completed on 31 January 2022.

### BHP Mitsui Coal (BMC) gain on disposal

On 3 May 2022 the Group sold its 80 per cent interest in BHP Mitsui Coal Pty Ltd (BMC) to Stanmore SMC Holdings Pty Ltd, a wholly owned subsidiary of Stanmore Resources Limited (Stanmore Resources).

Stanmore Resources paid US\$1.1 billion cash consideration at completion plus a preliminary completion adjustment of US\$218 million for working capital. Deferred consideration of US\$222 million comprised US\$100 million in cash, outstanding at 30 June 2022 and subsequently received on 3 November 2022, with potential for an additional amount of up to US\$150 million (US\$122 million discounted) in a price-linked earnout payable in the 2024 calendar year.

Details of the gain on disposal is as follows:	US\$M
BHP share of net assets disposed	631
Gross consideration	1,318
Transaction and other directly applicable costs	(69)
Income tax expense	–
Deferred consideration	222
Gain on disposal	840

## 4 Significant events – Samarco dam failure

On 5 November 2015, the Samarco Mineração S.A. (Samarco) iron ore operation in Minas Gerais, Brazil, experienced a tailings dam failure that resulted in a release of mine tailings, flooding the communities of Bento Rodrigues, Gesteira and Paracatu and impacting other communities downstream (the Samarco dam failure). Refer to section on ‘Samarco’ in the Operating and Financial Review.

Samarco is jointly owned by BHP Billiton Brasil Ltda (BHP Brasil) and Vale S.A. (Vale). BHP Brasil’s 50 per cent interest is accounted for as an equity accounted joint venture investment. BHP Brasil does not separately recognise its share of the underlying assets and liabilities of Samarco, but instead records the investment as one line on the balance sheet. Each period, BHP Brasil recognised its 50 per cent share of Samarco’s profit or loss and adjusted the carrying value of the investment in Samarco accordingly. Such adjustment continued until the investment carrying value was reduced to US\$ nil, with any additional share of Samarco losses only recognised to the extent that BHP Brasil has an obligation to fund the losses. After applying equity accounting, any remaining carrying value of the investment is tested for impairment.

Any charges relating to the Samarco dam failure incurred directly by BHP Brasil or other BHP entities are recognised 100 per cent in the Group’s results.

The financial impacts of the Samarco dam failure on the Group’s income statement, balance sheet and cash flow statement for the year ended 30 June 2024 are shown in the tables below and have been treated as an exceptional item.

### Financial impacts of Samarco dam failure

	2024	2023	2022
	US\$M	US\$M	US\$M
<b>Income statement</b>			
Expenses excluding net finance costs:			
Costs incurred directly by BHP Brasil and other BHP entities in relation to the Samarco dam failure <sup>1</sup>	(139)	(103)	(66)
(Loss)/profit from equity accounted investments, related impairments and expenses:			
Samarco dam failure provision <sup>2</sup>	(2,833)	(256)	(595)
Fair value change on forward exchange derivatives <sup>3</sup>	(199)	471	(81)
(Loss)/profit from operations	(3,171)	112	(742)
Net finance costs <sup>4</sup>	(506)	(452)	(290)
Loss before taxation	(3,677)	(340)	(1,032)
Income tax (expense)/benefit <sup>5</sup>	(85)	17	(31)
<b>Loss after taxation</b>	<b>(3,762)</b>	<b>(323)</b>	<b>(1,063)</b>
<b>Balance sheet movement</b>			
Other financial assets <sup>6</sup>	(280)	337	(160)
Trade and other payables	(4)	(6)	(1)
Tax liabilities	(85)	17	(31)
Provisions	(2,824)	(260)	(629)
<b>Net (increase)/decrease in liabilities</b>	<b>(3,193)</b>	<b>88</b>	<b>(821)</b>

	2024	2023	2022
	US\$M	US\$M	US\$M
<b>Cash flow statement</b>			
Loss before taxation	(3,677)	(340)	(1,032)
<i>Adjustments for:</i>			
Samarco dam failure provision <sup>2</sup>	2,833	256	595
Fair value change on forward exchange derivatives <sup>3</sup>	199	(471)	81
Proceeds of cash management related instruments	218	134	79
Net finance costs <sup>4</sup>	506	452	290
<i>Changes in assets and liabilities:</i>			
Trade and other payables	4	6	1
<b>Net operating cash flows</b>	<b>83</b>	<b>37</b>	<b>14</b>
Net investment and funding of equity accounted investments <sup>7</sup>	(640)	(448)	(256)
<b>Net investing cash flows</b>	<b>(640)</b>	<b>(448)</b>	<b>(256)</b>
<b>Net decrease in cash and cash equivalents</b>	<b>(557)</b>	<b>(411)</b>	<b>(242)</b>

<sup>1</sup> Includes legal and advisor costs incurred.

<sup>2</sup> US\$3,700 million (2023: US\$(33) million; 2022: US\$691 million) change in estimate and US\$(867) million (2023: US\$289 million; 2022: US\$(96) million) exchange translation.

<sup>3</sup> The Group enters into forward exchange contracts to limit the Brazilian reais exposure on the dam failure provision. While not applying hedge accounting, the fair value changes in the forward exchange instruments are recorded within (Loss)/profit from equity accounted investments, related impairments and expenses in the Income Statement.

<sup>4</sup> Amortisation of discounting of provision.

<sup>5</sup> Includes tax on forward exchange derivatives and other taxes incurred during the period.

<sup>6</sup> Includes forward exchange contracts described in item 3 above, and Senior notes issued by Samarco as part of its Judicial Reorganisation.

<sup>7</sup> Includes US\$(515) million (2023: US\$(448) million; 2022: US\$(256) million) utilisation of the Samarco dam failure provision and US\$(125) million provided to Samarco following approval of the Judicial Reorganisation (2023: US\$ nil; 2022: US\$ nil).

### Equity accounted investment in Samarco

BHP Brasil's investment in Samarco remains at US\$ nil. No dividends have been received by BHP Brasil from Samarco during the period and Samarco currently does not have profits available for distribution.

### Provision related to the Samarco dam failure

	<u>2024</u>	<u>2023</u>
	US\$M	US\$M
At the beginning of the financial year	3,681	3,421
Movement in provision	2,824	260
<i>Comprising:</i>		
Utilised	(515)	(448)
Adjustments charged to the income statement:		
Change in cost estimate	3,700	(33)
Amortisation of discounting impacting net finance costs	506	452
Exchange translation	(867)	289
<b>At the end of the financial year</b>	<b>6,505</b>	<b>3,681</b>
<i>Comprising:</i>		
Current	1,500	1,876
Non-current	5,005	1,805
<b>At the end of the financial year</b>	<b>6,505</b>	<b>3,681</b>

### Samarco dam failure provision and contingencies

As at 30 June 2024, BHP Brasil has identified a provision and certain contingent liabilities arising as a consequence of the Samarco dam failure. The provision related to the Samarco dam failure recognised as at 30 June 2024 is US\$6,505 million and reflects the Group's best estimate of the potential outflows necessary to resolve all aspects of the Federal Public Prosecution Office BRL\$155 billion claim and Framework Agreement obligations (see below).

Contingent liabilities will only be resolved when one or more uncertain future events occur or related impacts become capable of reliable measurement and, as such, determination of contingent liabilities disclosed in the Financial Statements requires significant judgement regarding the outcome of future events. A number of the claims below do not specify the amount of damages sought and, where this is specified, amounts could change as the matter progresses.

Ultimately, future changes in any matters for which a provision has been recognised or contingent liability disclosed could have a material adverse impact on BHP's business, competitive position, cash flows, prospects, liquidity and shareholder returns.



The following table summarises the current status of significant ongoing matters relating to the Samarco dam failure, along with developments during the financial year, and the associated treatment in the Financial Statements:

Item	Provision	Contingent liability
<i>Samarco dam failure – Framework Agreement</i>	✓	X
<p>On 2 March 2016, BHP Brasil, Samarco and Vale S.A. (Vale) entered into a Framework Agreement with the Federal Government of Brazil, the states of Espírito Santo and Minas Gerais, and certain other public authorities to establish a foundation (Fundação Renova) that is developing and executing environmental and socio-economic programs (Programs) to remediate and provide compensation for damage caused by the Samarco dam failure (the Framework Agreement).</p> <p>Key Programs include those for financial assistance and compensation of impacted persons and those for remediation of impacted areas and resettlement of impacted communities.</p> <p>Uncertainty exists around the scope and cost of the Programs, including as a result of ongoing legal actions in relation to the number of individuals eligible for compensation and the amount of damages to which they are entitled. Further information on the key areas of estimation uncertainty is provided in the ‘Key judgements and estimates’ section below.</p> <p>Samarco has primary responsibility for funding Fundação Renova with each of BHP Brasil and Vale having secondary funding obligations in proportion to their 50 per cent shareholding in Samarco. While Samarco has recommenced operations, Samarco’s long-term cash flow generation remains highly sensitive to factors including returning to full production capacity, commodity prices and foreign exchange rates.</p> <p>Further, under the Samarco Judicial Reorganisation (refer to Samarco Judicial Reorganisation (JR) below), Samarco’s funding of obligations to remediate and compensate the damages resulting from the dam failure, including funding Fundação Renova, is capped at US\$1 billion for the period CY2024 to CY2030. Notwithstanding this cap, and subject to certain conditions, to the extent that Samarco each year has a positive cash balance after meeting its various obligations, during this period Samarco’s shareholders are able to direct 50 per cent of Samarco’s year end excess cash balance to fund remediation and compensation obligations.</p> <p>Execution of the Programs is a key component in the resolution of the reparation process, including the Federal Public Prosecution Office claim and, therefore, the expected cost of executing the Programs and Samarco’s potential ability to contribute to remediation and compensation obligations have been considered when determining BHP Brasil’s provision in relation to the Samarco dam failure at 30 June 2024 (as outlined below).</p>		

For person

Item	Provision	Contingent liability
<i>Federal Public Prosecution Office claim</i>	✓	X
<p>BHP Brasil is among the defendants named in a claim brought by the Brazilian Federal Public Prosecution Office on 3 May 2016, seeking R\$155 billion (approximately US\$28 billion) for reparation, compensation and moral damages in relation to the Samarco dam failure.</p> <p>Since early CY2021, BHP Brasil, Samarco and Vale have been engaging in negotiations with the Brazilian State and Federal Government and other public entities to seek a settlement of obligations under the Framework Agreement, the Federal Public Prosecution Office Claim, and other claims by government entities relating to the Samarco dam failure (the ‘Settlement Negotiations’). The Settlement Negotiations are ongoing and the outcome is uncertain.</p> <p>As at 30 June 2023, the Group disclosed a contingent liability in relation to the Federal Public Prosecution Office claim as, given the status of the claim and ongoing settlement negotiations, it was not possible to reliably estimate the potential outcomes of the claim beyond the estimated costs of completing the Programs under the Framework Agreement, which are being executed in relation to financial assistance and compensation of impacted persons, remediation of impacted areas and resettlement of impacted communities.</p> <p>On 25 January 2024, the Federal Court of Brazil issued a decision in relation to the Federal Public Prosecution Office Claim finding Samarco, Vale and BHP Brasil jointly and severally liable to pay collective moral damages arising from the Samarco dam failure in the amount of R\$47.6 billion (US\$8.6 billion) (to be adjusted for interest and inflation). The decision also determined that payment will only occur when any and all appeals are finally determined.</p> <p>In March 2024, the Federal Court found that the correct historical amount due of collective moral damages is R\$46.7 billion (instead of R\$47.6 billion). In April and May 2024, Samarco, Vale, BHP Brasil and various governmental parties appealed the decision. The appeal process is estimated to take approximately two to five years. The Federal Court issued rulings on 8 May 2024 and 20 May 2024 denying the requests for early enforcement.</p> <p>On 27 June 2024, the Federal Court dismissed without prejudice certain claims directed at the Companies in the Federal Public Prosecution Office Claim, on the grounds that they are already covered by previous agreements and decisions (such as the Framework Agreement). This decision did not dismiss the collective moral damages decision outlined above and is also subject to appeal.</p> <p>In June 2024, the Public Prosecutors’ Office and the Public Defense Office filed a public civil claim against Samarco, BHP Brasil, Vale and Fundação Renova for alleged gender discrimination against women in the reparation process. They requested certain changes in Fundação Renova’s registration program, damages and an injunctive relief to implement emergency measures. On 14 August 2024, the Federal Court partially granted the injunctive relief request and ordered Fundação Renova to allow the review of the registration of all women who are either registered or have pending registration applications in Fundação Renova. The decision is subject to appeal.</p> <p>The Group has considered the additional information available from the status of the Settlement Negotiations (including all offers made by BHP Brasil, Samarco and Vale to date), updates to the estimated costs of executing the Framework Agreement Programs, the extent to which Samarco may be in a position to fund any future outflows and the judicial decision regarding collective moral damages to increase the provision related to the Samarco dam failure to US\$6,505 million at 30 June 2024.</p> <p>The provision at 30 June 2024 reflects the Group’s best estimate of outflows required to resolve all aspects of the Federal Public Prosecution Office claim, being reparation, compensation and moral damages, and the Framework Agreement.</p> <p>Significant uncertainty remains around the resolution of the Federal Public Prosecution Office Claim and the Framework Agreement obligations, and there is a risk that outcomes may be materially higher or lower than amounts reflected in BHP Brasil’s provision for the Samarco dam failure.</p> <p>Key areas of uncertainty include the terms of any potential future outcome of the Settlement Negotiations, the extent to which Samarco is able to directly fund any future obligations relating to reparation, compensation and moral damages and the outcomes of appeals relating to the judicial decision regarding collective moral damages. Further information on the key areas of estimation uncertainty is provided in the ‘Key judgements and estimates’ section below.</p> <p>BHP Brasil, Samarco and Vale continue to maintain security, as required by a Governance Agreement, ratified on 8 August 2018, with the security currently comprising insurance bonds and a charge over certain Samarco assets.</p>		
<i>Australian class action complaint</i>	X	✓
<p>BHP Group Limited is named as a defendant in a shareholder class action filed in the Federal Court of Australia on behalf of persons who acquired shares in BHP Group Limited or BHP Group Plc (now BHP Group (UK) Ltd) in periods prior to the Samarco dam failure.</p> <p>The amount of damages sought is unspecified. A trial is scheduled to commence in September 2025.</p>		

Item	Provision	Contingent liability
<p><i>United Kingdom group action complaint and Vale and Samarco's Netherlands collective action complaint</i></p> <p>BHP Group (UK) Ltd (formerly BHP Group Plc) and BHP Group Limited (BHP Defendants) are named as defendants in group action claims for damages filed in the courts of England. These claims were filed on behalf of certain individuals, municipalities, businesses, faith-based institutions and communities in Brazil allegedly impacted by the Samarco dam failure.</p> <p>The amount of damages sought in these claims is unspecified. A trial in relation to the BHP Defendants' liability for the dam failure is listed to commence in October 2024 and therefore a present obligation in relation to this matter is yet to be determined.</p> <p>In December 2022, the BHP Defendants filed their defence and a contribution claim against Vale. The contribution claim contended that if the BHP Defendants' defence is not successful and the BHP Defendants are ordered to pay damages to the claimants, Vale should contribute to any amount payable. Vale contested the jurisdiction of the English courts to determine the contribution claim, with those challenges ultimately dismissed in December 2023.</p> <p>In January 2024, the BHP Defendants were served with a new group action filed in the courts of England on behalf of additional individuals and businesses in Brazil allegedly impacted by the Samarco dam failure. The new action makes broadly the same claims as the original action and the amount of damages sought in these claims is unspecified.</p> <p>In March 2024, a collective action complaint was filed in the Netherlands against Vale and a Dutch subsidiary of Samarco for compensation relating to the Fundão Dam failure. The claim filed in the Netherlands indicates that these claims were filed on behalf of certain individuals, municipalities, businesses, associations and faith-based institutions allegedly impacted by the Samarco dam failure who are not also claimants in the UK group action claims referred to above. BHP is not a defendant in the Netherlands proceedings.</p> <p>In July 2024, the BHP Defendants, BHP Brasil and Vale entered into an agreement – without any admission of liability in any proceedings – whereby: (i) Vale will pay 50% of any amounts that may be payable by the BHP Defendants to the claimants in the UK group action claims (or by the BHP Defendants, BHP Brasil or their related parties to claimants in any other proceedings in Brazil, England or the Netherlands covered by the agreement); and (ii) BHP Brasil will pay 50% of any amounts that may be payable by Vale to the claimants in the Netherlands proceedings (or by Vale or its related parties to claimants in any other proceedings in Brazil, England or the Netherlands covered by the agreement). The agreement reinforces the terms of the Framework Agreement entered into in 2016 which require BHP Brasil and Vale to each contribute 50% to the funding of the Renova Foundation for compensation of persons impacted by the Fundão Dam failure where Samarco is unable to contribute that funding. The BHP Defendants withdrew the contribution claim against Vale in England as it is no longer necessary given this agreement.</p>	X	✓
<p><i>Criminal charges</i></p> <p>The Federal Prosecutors' Office has filed criminal charges against BHP Brasil, Samarco and Vale and certain employees and former employees of BHP Brasil (Affected Individuals) in the Federal Court of Ponte Nova, Minas Gerais.</p> <p>BHP Brasil rejects outright the charges against the company and the Affected Individuals and is defending itself from all charges while fully supporting each of the Affected Individuals in their defence of the charges.</p>	X	✓
<p><i>Civil public action commenced by Associations concerning the use of TANFLOC for water treatment</i></p> <p>The Vila Lenira Residents Association, State of Espirito Santo Rural Producers and Artisans Association, Colatina Velha Neighbourhood Residents Association, and United for the Progress of Palmeiras Neighbourhood Association have filed a lawsuit against Samarco, BHP Brasil and Vale and others, including the State of Minas Gerais, the State of Espirito Santo and the Federal Government.</p> <p>The plaintiffs allege that the defendants carried out a clandestine study on the citizens of the locations affected by the Fundão Dam Failure, using TANFLOC – a tannin-based flocculant/coagulant – that is currently used for wastewater treatment applications. The plaintiffs claim that this product allegedly put the population at risk due to its alleged experimental qualities.</p> <p>The plaintiffs are seeking multiple kinds of relief – material damages, moral damages, loss of profits – and that the defendants should pay for water supply in all locations where there is no water source other than the Doce River.</p> <p>On 17 November 2023, the Federal Court dismissed the lawsuit without prejudice considering the Association's lack of standing to sue and the defectiveness of the complaint. The Associations filed a motion for clarification and the decision is still subject to appeal.</p>	X	✓
<p><i>Other claims</i></p> <p>BHP Brasil is among the companies named as defendants in a number of legal proceedings initiated by individuals, non-governmental organisations, corporations and governmental entities in Brazilian Federal and State courts following the Samarco dam failure. The other defendants include Vale, Samarco and Fundação Renova.</p> <p>The lawsuits include claims for compensation, environmental reparation and violations of Brazilian environmental and other laws, among other matters. The lawsuits seek various remedies including reparation costs, compensation to injured individuals and families of the deceased, recovery of personal and property losses, moral damages and injunctive relief.</p> <p>Certain of these legal proceedings are outside the scope of the negotiations currently in progress aimed at resolving all aspects of the Federal Public Prosecution Office BRL\$155 billion claim and Framework Agreement obligations.</p> <p>In addition, government inquiries, studies and investigations relating to the Samarco dam failure have been commenced by numerous agencies and individuals of the Brazilian government and are ongoing.</p> <p>Additional lawsuits and government investigations relating to the Samarco dam failure could be brought against BHP Brasil and other Group entities in Brazil or other jurisdictions.</p> <p>The outcomes of these claims, investigations and proceedings remain uncertain and continue to be disclosed as contingent liabilities.</p>	X	✓

## Commitments

Under the terms of the Samarco joint venture agreement, BHP Brasil does not have an existing obligation to fund Samarco.

However, BHP Brasil has agreed to fund a total of up to US\$925 million for the Fundação Renova programs during calendar year 2024, with US\$194 million being funded in the six month period to 30 June 2024. Any additional requests for funding or future investment provided would be subject to a future decision by BHP Brasil, accounted for at that time.

## Samarco judicial reorganisation

Samarco filed for Judicial Reorganisation (JR) in April 2021, with the Second Business State Court for the Belo Horizonte District of Minas Gerais, State of Minas Gerais, Brazil (JR Court), following enforcement actions taken by certain financial creditors of Samarco which threatened Samarco's operations.

The JR was an insolvency proceeding that provided a means for Samarco to restructure its financial debts and establish a stable financial position to allow Samarco to continue to rebuild its operations and strengthen its ability to meet obligations in relation to reparation, compensation and moral damages in relation to the Samarco dam failure. Samarco's operations continued during the JR proceeding.

On 28 July 2023, Samarco and one of its supporting creditors jointly filed a consensual Judicial Reorganisation Plan (Consensual Plan) with the JR Court, which provided, among other things, that the agreements entered into between Samarco and Brazilian public authorities in connection with the Fundão dam failure will not be impaired by the Consensual Plan and Samarco will continue to have the primary obligation to fund Fundação Renova.

On 1 September 2023, the JR Court ratified the Consensual Plan. Following the ratification, Samarco entered into definitive debt restructure agreements with its financial creditors to implement the debt restructure, including the exchange of Samarco's existing financial debt for US\$3.6 billion of long-term unsecured debt that matures in June 2031 and remains non-recourse to Samarco's shareholders. Further, as part of the agreement Samarco issued Senior notes to its Shareholders which also mature in June 2031.

Samarco has paid the majority of labour claims, suppliers and other non-financial creditors as required by the Consensual Plan.

The debt restructure does not impact Fundação Renova's ability to undertake the Programs under the Framework Agreement. Samarco continues to have primary responsibility for funding Fundação Renova and each of BHP Brasil and Vale will continue to have secondary responsibility to fund 50% of Fundação Renova if Samarco does not meet its funding obligations under the Framework Agreement. Under the Consensual Plan, Samarco's funding obligation to remediate and compensate the damages resulting from the dam failure, including funding Fundação Renova, is capped at US\$1 billion for the period CY2024 to CY2030 (Renova Cap). Notwithstanding the Renova Cap, and subject to certain conditions, to the extent that Samarco each year has a positive cash balance after meeting its various obligations including operating capital requirements, debt service and Renova Cap requirements, Samarco's shareholders are able to direct 50% of Samarco's year end excess cash balance to fund remediation and compensation obligations.

BHP Brasil has considered the extent to which Samarco may be in a position to fund any future outflows, when determining the dam failure related provision at 30 June 2024.

## Key judgements and estimates

### *Judgements*

The outcomes of litigation are inherently difficult to predict and significant judgement has been applied in assessing the likely outcome of legal claims and determining which legal claims require recognition of a provision or disclosure of a contingent liability. The facts and circumstances relating to these cases are regularly evaluated in determining whether a provision for any specific claim is required.

Management has determined that a provision can be recognised at 30 June 2024 to reflect the estimated costs to resolve all aspects of the Federal Public Prosecution Office claim and the Framework Agreement. It is not yet possible to provide a range of possible outcomes or a reliable estimate of potential future exposures to BHP in connection to the contingent liabilities noted above, given their status.

### *Estimates*

The provision for the Samarco dam failure reflects the Group's estimate of the costs to resolve all aspects of the Federal Public Prosecution Office claim and Framework Agreement and requires the use of significant judgements, estimates and assumptions.

While the provision has been measured based on the latest information available, changes in facts and circumstances are likely in future reporting periods and may lead to material revisions to these estimates and there is a risk that outcomes may be materially higher or lower than amounts currently reflected in the provision. However, it is currently not possible to determine what facts and circumstances may change, therefore revisions in future reporting periods due to the key estimates and factors outlined below cannot be reliably measured.

The key estimates that may have a material impact upon the provision in the next and future reporting periods include:

- the terms of any potential future settlement agreement seeking a definitive and substantive settlement of claims relating to the Samarco dam failure, including amounts payable, obligations of the parties to perform ongoing Programs of work in relation to reparation and compensation, and the period of time over which any settlement amounts may be payable. A one year increase or decrease, in isolation, to the period over which amounts payable have been estimated to be settled would result in a change to the dam failure provision of approximately US\$125 million;
- the scope and cost of executing the Programs under the Framework Agreement, including as a result of ongoing legal actions in relation to the number of people eligible for compensation and the amount of damages to which they are entitled;
- the outcomes of appeals relating to the judicial decision regarding collective moral damages, including any appeals that may be lodged by the Brazilian Federal Public Prosecution Office; and
- the extent to which Samarco is able to directly fund any future obligations relating to reparation, compensation or moral damages. Samarco's long-term cash flow generation remains highly sensitive to factors including its ability to return to full production capacity, commodity prices and foreign exchange rates.

The provision may also be affected by factors including but not limited to updates to discount and foreign exchange rates. A 0.5% increase in the discount rate would, in isolation, reduce the provision by approximately US\$130 million.

In addition, the provision may be impacted by decisions in, or resolution of, existing and potential legal claims in Brazil and other jurisdictions, including the outcome of the United Kingdom group action claims, the Australian class action and the claim filed in the Netherlands against Vale and a Dutch subsidiary of Samarco.

Given these factors, future actual cash outflows may differ from the amounts currently provided and changes to any of the key assumptions and estimates outlined above could result in a material impact to the provision in the next and future reporting periods.

The following section provides disclosure of matters to which Samarco (and not the Group) is a party.

## **Samarco**

### ***Dam failure related provision and contingencies***

In addition to its provisions in relation to the Framework Agreement and the Federal Public Prosecution Office claim as at 30 June 2024, Samarco has recognised provisions of US\$0.4 billion (30 June 2023: US\$0.4 billion), based on currently available information, in relation to other dam failure related matters to which BHP Brasil is not a party. The magnitude, scope and timing of these additional costs are subject to a high degree of uncertainty and Samarco has indicated that it anticipates that it will incur future costs beyond those provided. These uncertainties are likely to continue for a significant period and changes to key assumptions could result in a material change to the amount of the provision in future reporting periods. Any such unrecognised obligations are therefore contingent liabilities and, at present, it is not practicable to estimate their magnitude or possible timing of payment. Accordingly, it is also not possible to provide a range of possible outcomes or a reliable estimate of total potential future exposures at this time.

Samarco is also named as a defendant in a number of other legal proceedings initiated by individuals, non-governmental organisations, corporations and governmental entities in Brazilian Federal and State courts following the Samarco dam failure. The lawsuits include claims for compensation, environmental rehabilitation and violations of Brazilian environmental and other laws, among other matters. The lawsuits seek various remedies including rehabilitation costs, compensation to injured individuals and families of the deceased, recovery of personal and property losses, moral damages and injunctive relief. In addition, government inquiries and investigations relating to the Samarco dam failure have been commenced by numerous agencies of the Brazilian government and are ongoing. Given the status of proceedings it is not possible to provide a range of possible outcomes or a reliable estimate of total potential future exposures to Samarco.

Additional lawsuits and government investigations relating to the Samarco dam failure could be brought against Samarco.

Samarco has also identified a number of individually immaterial tax-related uncertainties which have been reflected, where appropriate, in the Group's share of associate and joint venture contingent liabilities presented in note 34 'Contingent liabilities'.

### **Samarco insurance**

Samarco has standalone insurance policies in place with Brazilian and global insurers. Insurers' loss adjusters or claims representatives continue to investigate and assist with the claims process for matters not yet settled. As at 30 June 2024, an insurance receivable has not been recognised by Samarco in respect of ongoing matters.

### **Samarco non-dam failure related provisions and contingent liabilities**

The following non-dam failure related matters pre-date and are unrelated to the Samarco dam failure. Samarco is currently contesting aspects of both of these matters in the Brazilian courts. Given the status of these tax matters, the timing of resolution and potential economic outflow for Samarco is uncertain.

#### ***Brazilian Social Contribution Levy***

Samarco has received tax assessments for the alleged non-payment of Brazilian Social Contribution Levy for the calendar years 2007-2014. Based on its assessment of currently available information as at 30 June 2024, Samarco recognised gross provisions of US\$0.4 billion, US\$0.2 billion net of US\$0.2 billion court deposits paid (30 June 2023: gross provisions of US\$1.1 billion, US\$0.9 billion net of US\$0.2 billion court deposits paid) and disclosed contingent liabilities of US\$0.2 billion (30 June 2023: US \$0.2 billion). As at 30 June 2024, BHP Brasil's 50% share of the impact of the provision recognised by Samarco is reflected in the Group's equity accounting for Samarco.

#### ***Brazilian corporate income tax rate***

Samarco has received tax assessments, and disclosed contingent liabilities, for alleged incorrect calculation of Corporate Income Tax (IRPJ) in respect of the 2000-2003 and 2007-2014 income years totalling approximately US\$1.0 billion (30 June 2023: US\$1.1 billion).

## 5 Expenses and other income

	<u>2024</u>	<u>2023</u>	<u>2022</u>
	US\$M	US\$M	US\$M
Employee benefits expense:			
Wages and salaries	4,633	4,539	4,197
Employee share awards	112	97	109
Social security costs	5	4	4
Pension and other post-retirement obligations	374	339	338
Less employee benefits expense classified as exploration and evaluation expenditure	(49)	(35)	(30)
Changes in inventories of finished goods and work in progress	(289)	301	(774)
Raw materials and consumables used	6,536	6,710	5,991
Freight and transportation	2,270	2,299	2,319
External services	5,795	4,768	4,525
Third-party commodity purchases	1,977	1,878	2,959
Net foreign exchange losses/(gains)	23	(197)	(326)
Fair value change on derivatives <sup>1</sup>	84	135	(29)
Government royalties paid and payable	3,571	3,841	4,014
Exploration and evaluation expenditure incurred and expensed in the current period	399	294	199
Depreciation and amortisation expense	5,295	5,061	5,683
Net impairments:			
Property, plant and equipment	3,833	73	515
Goodwill and other intangible assets	57	2	–
All other operating expenses	2,124	1,764	2,677
<b>Total expenses</b>	<b>36,750</b>	<b>31,873</b>	<b>32,371</b>
(Gain)/loss on disposal of subsidiaries and operations <sup>2</sup>	(915)	(8)	(840)
Dividend income <sup>3</sup>	(1)	(19)	(241)
Other income <sup>4</sup>	(369)	(367)	(317)
<b>Total other income</b>	<b>(1,285)</b>	<b>(394)</b>	<b>(1,398)</b>

<sup>1</sup> Fair value change on derivatives is principally related to commodity price contracts, foreign exchange contracts and embedded derivatives used in the ordinary course of business as well as derivatives used as part of the funding of dividends.

<sup>2</sup> Mainly relates to the divestment of Blackwater and Daunia mines in FY2024 and BMC in FY2022. Refer to note 3 'Exceptional items' for further information.

<sup>3</sup> During FY2022, the Group received dividends of US\$238 million from Cerrejón. On 11 January 2022, BHP completed the sale of its 33.33 per cent interest in Cerrejón to joint venture partner, Glencore plc. In accordance with the sale agreement, the final sale proceeds were adjusted for the dividends received to a final number of US\$50 million.

<sup>4</sup> Other income is generally income earned from transactions outside the course of the Group's ordinary activities and may include certain management fees from non-controlling interests and joint arrangements, royalties and commission income.

### Recognition and measurement

Other income is recognised when it is probable that the economic benefits associated with a transaction will flow to the Group and can be reliably measured. Dividend income is recognised upon declaration.

## 6 Income tax expense

	<u>2024</u>	<u>2023</u>	<u>2022</u>
	US\$M	US\$M	US\$M
<b>Total taxation expense comprises:</b>			
Current tax expense	7,435	6,690	10,673
Deferred tax (benefit)/expense	(988)	387	64
<b>Total taxation expense</b>	<b>6,447</b>	<b>7,077</b>	<b>10,737</b>

	<u>2024</u>	<u>2023</u>	<u>2022</u>
	US\$M	US\$M	US\$M
<b>Factors affecting income tax expense for the year</b>			
Income tax expense differs to the standard rate of corporation tax as follows:			
Profit before taxation	16,048	21,401	33,137
Tax on profit at Australian prima facie tax rate of 30 per cent	4,814	6,420	9,941
Tax effect of (loss)/profit from equity accounted investments, related impairments and expenses <sup>1</sup>	737	(37)	(19)
Derecognition of deferred tax assets and current year tax losses <sup>2</sup>	666	526	1,087
Tax on remitted and unremitted foreign earnings	224	137	441
Amounts (over)/under provided in prior years	(25)	(18)	(80)
Foreign exchange adjustments	(79)	94	(233)
Recognition of previously unrecognised tax assets	(110)	(109)	(3)
Impact of tax rates applicable outside of Australia	(556)	(558)	(801)
Other	344	236	97
<b>Income tax expense</b>	<b>6,015</b>	<b>6,691</b>	<b>10,430</b>
<b>Royalty-related taxation (net of income tax benefit)<sup>3</sup></b>	<b>432</b>	<b>386</b>	<b>307</b>
<b>Total taxation expense</b>	<b>6,447</b>	<b>7,077</b>	<b>10,737</b>

<sup>1</sup> This item removes the prima facie tax effect on (loss)/profit from equity accounted investments, related impairments and expenses that are net of tax, with the exception of the Samarco forward exchange derivatives described in note 4 'Significant events – Samarco dam failure', which are taxable.

<sup>2</sup> Includes the tax impacts related to the exceptional impairments of US deferred tax assets in the year ended 30 June 2022 as presented in note 3 'Exceptional items'.

<sup>3</sup> Includes the revaluation of deferred tax balances in the year ended 30 June 2023, following the substantive enactment of the Chilean Royalty Bill, as presented in note 3 'Exceptional items'.

Income tax recognised in other comprehensive income is as follows:

	<u>2024</u>	<u>2023</u>	<u>2022</u>
	US\$M	US\$M	US\$M
<b>Income tax effect of:</b>			
<u>Items that may be reclassified subsequently to the income statement:</u>			
Hedges:			
(Losses)/gains taken to equity	10	(29)	274
Losses/(gains) transferred to the income statement	(15)	45	(264)
Others	–	(11)	–
Income tax (charge)/credit relating to items that may be reclassified subsequently to the income statement	(5)	5	10
<u>Items that will not be reclassified to the income statement:</u>			
Re-measurement gains/(losses) on pension and medical schemes	(13)	7	(9)
Income tax (charge)/credit relating to items that will not be reclassified to the income statement	(13)	7	(9)
<b>Total income tax (charge)/credit relating to components of other comprehensive income<sup>1</sup></b>	<b>(18)</b>	<b>12</b>	<b>1</b>

<sup>1</sup> Included within total income tax relating to components of other comprehensive income is US\$(18) million relating to deferred taxes and US\$ nil relating to current taxes (2023: US\$12 million and US\$ nil; 2022: US\$1 million and US\$ nil).



## Recognition and measurement

Taxation on the profit/(loss) for the year comprises current and deferred tax. Taxation is recognised in the income statement except to the extent that it relates to items recognised directly in equity or other comprehensive income, in which case the tax effect is also recognised in equity or other comprehensive income.

### Current tax

Current tax is the expected tax on the taxable income for the year, using tax rates and laws enacted or substantively enacted at the reporting date, and any adjustments to tax payable in respect of previous years.

### Deferred tax

Deferred tax is the tax expected to be payable or recoverable on differences between the carrying amounts of assets and liabilities in the Financial Statements and the corresponding tax bases used in the computation of taxable profit, and is accounted for in accordance with IAS 12/AASB 112 'Income Taxes' (IAS 12).

Deferred tax is generally provided on temporary differences arising between the tax bases of assets and liabilities and their carrying amounts in the Financial Statements. Deferred tax assets are recognised to the extent that it is probable that future taxable profits will be available against which the temporary differences can be utilised.

Deferred tax is not recognised for temporary differences relating to:

- initial recognition of goodwill
- initial recognition of assets or liabilities in a transaction that is not a business combination and that affects neither accounting nor taxable profit, except where the transaction gives rise to equal and offsetting taxable and deductible temporary differences
- investment in subsidiaries, associates and jointly controlled entities where the Group is able to control the timing of the reversal of the temporary difference and it is probable that they will not reverse in the foreseeable future

Deferred tax is measured at the tax rates that are expected to be applied when the asset is realised or the liability is settled, based on the laws that have been enacted or substantively enacted at the reporting date.

Current and deferred tax assets and liabilities are offset when the Group has a legally enforceable right to offset and when the tax balances are related to taxes levied by the same tax authority and the Group intends to settle on a net basis, or realise the asset and settle the liability simultaneously.

### Royalty-related taxation

Royalties are treated as taxation arrangements (impacting income tax expense/(benefit)) when they are imposed under government authority and the amount payable is calculated by reference to revenue derived (net of any allowable deductions) after adjustment for temporary differences. Obligations arising from royalty arrangements that do not satisfy these criteria are recognised as current liabilities and included in expenses.

## International Tax Reform – Pillar Two Model Rules

The Organisation for Economic Co-operation and Development (OECD)/G20 Inclusive Framework on Base Erosion and Profit Shifting previously published the Pillar Two model rules designed to address the tax challenges arising from the digitalisation of the global economy, including the implementation of a global minimum tax. The Group has a presence in jurisdictions that have enacted or substantively enacted legislation in relation to the OECD/G20 BEPS Pillar Two model rules.

The enacted or substantively enacted rules apply to income years commencing on or after 1 January 2024 and, on this basis, there is no current tax impact for the income year ended 30 June 2024. The temporary exception to recognising and disclosing information about deferred tax assets and liabilities related to Pillar Two income taxes has been applied at 30 June 2024, pursuant to the amendments to IAS 12 issued on 23 May 2023 and 27 June 2023 by the IASB and AASB respectively.

The Group continues to monitor and evaluate the domestic implementation of the Pillar Two rules in the jurisdictions in which it operates. The Group's potential exposure to Pillar Two taxes, based on legislation that is enacted or substantively enacted, is not expected to be material.

## Uncertain tax and royalty matters

The Group operates across many tax jurisdictions. Application of tax law can be complex and requires judgement to assess risk and estimate outcomes. These judgements are subject to risk and uncertainty, hence there is a possibility that changes in circumstances will alter expectations, which may impact the amount of tax assets and tax liabilities, including deferred tax, recognised on the balance sheet and the amount of other tax losses and temporary differences not yet recognised. The evaluation of tax risks considers both amended assessments received and potential sources of challenge from tax authorities. The status of proceedings for these matters will impact the ability to determine the potential exposure and in some cases, it may not be possible to determine a range of possible outcomes or a reliable estimate of the potential exposure.

Tax and royalty matters with uncertain outcomes arise in the normal course of business and occur due to changes in tax law, changes in interpretation of tax law, periodic challenges and disagreements with tax authorities and legal proceedings.

Tax and royalty obligations assessed as having probable future economic outflows capable of reliable measurement are provided for as at 30 June 2024. Matters with a possible economic outflow and/or presently incapable of being measured reliably are contingent liabilities and disclosed in note 34 'Contingent liabilities'. Details of uncertain tax and royalty matters relating to Samarco are disclosed in note 4 'Significant events – Samarco dam failure'.

## Key judgements and estimates

### Income tax classification

*Judgements:* The Group's accounting policy for taxation, including royalty-related taxation, requires management's judgement as to the types of arrangements considered to be a tax on income in contrast to an operating cost.

### Deferred tax

*Judgements:* Judgement is required in:

- determining the amount of deferred tax assets to be recognised based on the likely timing and the level of future taxable profits;
- assessing whether changes in tax regimes or applicable tax rates are substantively enacted at the reporting date;
- recognising deferred tax liabilities arising from temporary differences in investments. These deferred tax liabilities caused principally by retained earnings held in foreign tax jurisdictions are recognised unless repatriation of retained earnings can be controlled and is not expected to occur in the foreseeable future.

In FY2023, judgement was applied in determining the Chilean Royalty Bill was substantively enacted at the reporting date. It was considered that the process of enactment was complete and the remaining steps for enactment would not change the outcome of the tax rates to be applied in measuring the deferred tax assets and liabilities.

*Estimates:* The Group assesses the recoverability of recognised and unrecognised deferred taxes, including losses in Australia, the United States and Canada on a consistent basis. Estimates and assumptions relating to projected earnings and cash flows as applied in the Group impairment process are used for operating assets.

These forecasts are also used to estimate the royalty-related tax rates to apply when the deferred tax assets are realised and deferred tax liabilities are settled.

## 7 Earnings per share

	2024	2023	2022
<b>Earnings attributable to BHP shareholders (US\$M)</b>			
- Continuing operations	7,897	12,921	20,245
- Total	7,897	12,921	30,900
<b>Weighted average number of shares (Million)</b>			
- Basic	5,068	5,064	5,061
- Diluted	5,077	5,073	5,071
<b>Basic earnings per ordinary share (US cents)</b>			
- Continuing operations	155.8	255.2	400.0
- Total	155.8	255.2	610.6
<b>Diluted earnings per ordinary share (US cents)</b>			
- Continuing operations	155.5	254.7	399.2
- Total	155.5	254.7	609.3
<b>Headline earnings per ordinary share (US cents)</b>			
- Basic	195.9	256.1	439.0
- Diluted	195.6	255.7	438.1

Refer to note 28 'Discontinued operations' for basic earnings per share and diluted earnings per share for Discontinued operations.

Earnings on American Depositary Shares represent twice the earnings for BHP Group Limited ordinary shares.

Headline earnings is a Johannesburg Stock Exchange defined performance measure and is reconciled from earnings attributable to ordinary shareholders as follows:

	2024	2023	2022
	US\$M	US\$M	US\$M
<b>Earnings attributable to BHP shareholders</b>	7,897	12,921	30,900
<b>Adjusted for:</b>			
(Gain)/loss on sales of property, plant and equipment, intangibles and investments	(29)	(9)	(95)
Impairments of property, plant and equipment and intangibles	3,905	75	515
Gain on disposal of subsidiaries and operations	(915)	-	(840)
Gain on merger of Petroleum	-	-	(8,167)
Tax effect of above adjustments	(928)	(17)	(97)
Subtotal of adjustments	2,033	49	(8,684)
<b>Headline earnings</b>	9,930	12,970	22,216
<b>Diluted headline earnings</b>	9,930	12,970	22,216

### Recognition and measurement

Diluted earnings attributable to BHP shareholders are equal to the earnings attributable to BHP shareholders.

Following unification of the BHP corporate structure on 31 January 2022, the aggregate weighted average number of ordinary shares of only BHP Group Limited is considered in the composition of basic earnings per share. The calculation of the number of ordinary shares used in the computation of basic earnings per share is the weighted average number of ordinary shares of BHP Group Limited outstanding during the period after deduction of the number of shares held by the BHP Group Limited Employee Equity Trust.

For the purposes of calculating diluted earnings per share, the effect of 9 million dilutive shares has been taken into account for the year ended 30 June 2024 (2023: 9 million shares; 2022: 10 million shares). The Group's only potential dilutive ordinary shares are share awards granted under the employee share ownership plans for which terms and conditions are described in note 26 'Employee share ownership plans'. Diluted earnings per share calculation excludes instruments which are considered antidilutive.

At 30 June 2024, there are no instruments which are considered antidilutive (2023: nil; 2022: nil).

## Working capital

### 8 Trade and other receivables

	<u>2024</u>	<u>2023</u>
	US\$M	US\$M
Trade receivables	3,687	3,418
Other receivables	1,652	1,324
<b>Total</b>	<b>5,339</b>	<b>4,742</b>
Comprising:		
Current	5,169	4,594
Non-current	170	148

#### Recognition and measurement

Trade receivables are recognised initially at their transaction price or, for those receivables containing a significant financing component, at fair value. Trade receivables are subsequently measured at amortised cost using the effective interest method, less an allowance for impairment, except for provisionally priced receivables which are subsequently measured at fair value through profit or loss under IFRS 9.

The collectability of trade and other receivables is assessed continuously. At the reporting date, specific allowances are made for any expected credit losses based on a review of all outstanding amounts at reporting period-end. Individual receivables are written off when management deems them unrecoverable. The net carrying amount of trade and other receivables approximates their fair values.

#### Credit risk

Trade receivables generally have terms of less than 30 days. The Group has no material concentration of credit risk with any single counterparty and is not dominantly exposed to any individual industry.

Credit risk can arise from the non-performance by counterparties of their contractual financial obligations towards the Group. To manage credit risk, the Group maintains Group-wide procedures covering the application for credit approvals, granting and renewal of counterparty limits, proactive monitoring of exposures against these limits and requirements triggering secured payment terms. As part of these processes, the credit exposures with all counterparties are regularly monitored and assessed on a timely basis. The credit quality of the Group's customers is reviewed and the solvency of each debtor and their ability to pay the receivable is considered in assessing receivables for impairment.

The 10 largest customers represented 39 per cent (2023: 31 per cent) of total credit risk exposures managed by the Group.

Receivables are deemed to be past due or impaired in accordance with the Group's terms and conditions. These terms and conditions are determined on a case-by-case basis with reference to the customer's credit quality, payment performance and prevailing market conditions. As at 30 June 2024, trade receivables of US\$59 million (2023: US\$8 million) were past due but not impaired. The majority of these receivables were less than 30 days overdue.

At 30 June 2024, trade receivables are stated net of provisions for expected credit losses of US\$1 million (2023: US\$9 million).

### 9 Trade and other payables

	<u>2024</u>	<u>2023</u>
	US\$M	US\$M
Trade payables	5,338	4,893
Other payables	1,426	1,407
<b>Total</b>	<b>6,764</b>	<b>6,300</b>
Comprising:		
Current	6,719	6,296
Non-current	45	4

## 10 Inventories

	2024	2023	Definitions
	US\$M	US\$M	
Raw materials and consumables	2,305	2,106	Spares, consumables and other supplies yet to be utilised in the production process or in the rendering of services.
Work in progress	3,516	3,514	Commodities currently in the production process that require further processing by the Group to a saleable form.
Finished goods	1,218	1,003	Commodities ready-for-sale and not requiring further processing by the Group.
<b>Total<sup>1</sup></b>	<b>7,039</b>	<b>6,623</b>	
Comprising:			Inventories classified as non-current are not expected to be utilised or sold within 12 months after the reporting date or within the operating cycle of the business.
Current	5,828	5,220	
Non-current	1,211	1,403	

<sup>1</sup> Inventory write-downs of US\$69 million were recognised during the year (2023: US\$100 million; 2022: US\$163 million). Inventory write-downs of US\$19 million made in previous periods were reversed during the year (2023: US\$37 million; 2022: US\$23 million).

### Recognition and measurement

Regardless of the type of inventory and its stage in the production process, inventories are valued at the lower of cost and net realisable value. Cost is determined primarily on the basis of average costs and involves estimates of expected metal recoveries and work in progress volumes, calculated using available industry, engineering and scientific data. These estimates are periodically reassessed by the Group taking into account technical analysis and historical performance.

For processed inventories, cost is derived on an absorption costing basis. Cost comprises costs of purchasing raw materials and costs of production, including attributable mining and manufacturing overheads taking into consideration normal operating capacity.

Inventory quantities are assessed primarily through surveys and assays.

## Resource assets

### 11 Property, plant and equipment

	Land and buildings	Plant and equipment	Other mineral assets	Assets under construction	Exploration and evaluation	Total
	US\$M	US\$M	US\$M	US\$M	US\$M	US\$M
<b>Net book value – 30 June 2024</b>						
At the beginning of the financial year	8,140	36,654	13,304	13,481	239	71,818
Additions <sup>1</sup>	27	1,206	795	8,840	58	10,926
Remeasurements of index-linked freight contracts <sup>2</sup>	–	230	–	–	–	230
Depreciation for the year	(637)	(4,287)	(264)	–	–	(5,188)
Impairments for the year <sup>3</sup>	(88)	(1,440)	(930)	(1,365)	(10)	(3,833)
Disposals	(1)	(15)	–	–	–	(16)
Divestment of subsidiaries and operations <sup>4</sup>	(293)	(1,093)	(23)	(44)	–	(1,453)
Transfers and other movements	417	3,249	(655)	(3,815)	(51)	(855)
<b>At the end of the financial year<sup>5</sup></b>	<b>7,565</b>	<b>34,504</b>	<b>12,227</b>	<b>17,097</b>	<b>236</b>	<b>71,629</b>
– Cost	15,180	86,989	19,900	19,106	1,035	142,210
– Accumulated depreciation and impairments	(7,615)	(52,485)	(7,673)	(2,009)	(799)	(70,581)
<b>Net book value – 30 June 2023</b>						
At the beginning of the financial year	8,079	35,500	8,494	9,031	191	61,295
Additions <sup>1</sup>	194	1,024	842	6,332	56	8,448
Acquisition of subsidiaries and operations <sup>6</sup>	88	2,256	4,612	720	–	7,676
Remeasurements of index-linked freight contracts <sup>2</sup>	–	53	–	–	–	53
Depreciation for the year	(586)	(4,156)	(225)	–	–	(4,967)
Impairments for the year <sup>3</sup>	–	(73)	–	–	–	(73)
Disposals	(2)	(6)	–	–	–	(8)
Transfers and other movements	367	2,056	(419)	(2,602)	(8)	(606)
<b>At the end of the financial year<sup>5</sup></b>	<b>8,140</b>	<b>36,654</b>	<b>13,304</b>	<b>13,481</b>	<b>239</b>	<b>71,818</b>
– Cost	15,258	85,394	19,420	14,245	1,029	135,346
– Accumulated depreciation and impairments	(7,118)	(48,740)	(6,116)	(764)	(790)	(63,528)

- 1 Includes change in estimates and net foreign exchange gains/(losses) related to the closure and rehabilitation provisions for operating sites. Refer to note 15 'Closure and rehabilitation provisions'.
- 2 Relates to remeasurements of index-linked freight contracts including continuous voyage charters (CVCs). Refer to note 22 'Leases'.
- 3 Refer to note 13 'Impairment of non-current assets' for information on impairments.
- 4 Relates to the divestment of the Blackwater and Daunia mines completed on 2 April 2024. Refer to note 3 'Exceptional items' for more information.
- 5 Includes the carrying value of the Group's right-of-use assets relating to land and buildings and plant and equipment of US\$2,708 million (2023: US\$2,809 million). Refer to note 22 'Leases' for the movement of the right-of-use assets.
- 6 Relates to the acquisition of OZL on 2 May 2023. Refer to note 29 'Business combinations' for more information.

## Recognition and measurement

### Property, plant and equipment

Property, plant and equipment is recorded at cost less accumulated depreciation and impairment charges. Cost is the fair value of consideration given to acquire the asset at the time of its acquisition or construction and includes the direct costs of bringing the asset to the location and the condition necessary for operation and the estimated future costs of closure and rehabilitation of the facility.

Right-of-use assets are measured at cost, less any accumulated depreciation and impairment losses, and adjusted for any remeasurement of lease liabilities. Refer to note 22 'Leases' for further details. Right-of-use assets are presented within the category of property, plant and equipment according to the nature of the underlying asset leased.

### Exploration and evaluation

Exploration costs are incurred to discover mineral resources. Evaluation costs are incurred to assess the technical feasibility and commercial viability of resources found.

Exploration and evaluation expenditure is charged to the income statement as incurred, except in the following circumstances in which case the expenditure may be capitalised:

- the exploration and evaluation activity is within an area of interest that was previously acquired as an asset acquisition or in a business combination and measured at fair value on acquisition or
- the existence of a commercially viable mineral deposit has been established

A regular review of each area of interest is undertaken to determine the appropriateness of continuing to carry forward costs in relation to that area. Capitalised costs are only carried forward to the extent that they are expected to be recovered through the successful exploitation of the area of interest or alternatively by its sale. To the extent that capitalised expenditure is no longer expected to be recovered, it is charged to the income statement.

### Development expenditure

When proven mineral reserves are determined and development is sanctioned, capitalised exploration and evaluation expenditure is reclassified as assets under construction within property, plant and equipment. All subsequent development expenditure is capitalised and classified as assets under construction, provided commercial viability conditions continue to be satisfied.

The Group may use funds sourced from external parties to finance the acquisition and development of assets and operations. Finance costs are expensed as incurred, except where they relate to the financing of construction or development of qualifying assets. Borrowing costs directly attributable to acquiring or constructing a qualifying asset are capitalised during the development phase.

In the instance where saleable material is extracted prior to the commissioning of a project/site, sale proceeds are recognised as revenue, with associated costs also recognised in the income statement. On completion of development, all assets included in assets under construction are reclassified as either plant and equipment or other mineral assets and depreciation commences.

### Other mineral assets

Other mineral assets comprise:

- capitalised exploration, evaluation and development expenditure for assets in production
- mineral rights acquired
- capitalised development and production stripping costs

#### *Overburden removal costs*

The process of removing overburden and other waste materials to access mineral deposits is referred to as stripping. Stripping is necessary to obtain access to mineral deposits and occurs throughout the life of an open-pit mine. Development and production stripping costs are classified as other mineral assets in property, plant and equipment.

Stripping costs are accounted for separately for individual components of an ore body. The determination of components is dependent on the mine plan and other factors, including the size, shape and geotechnical aspects of an ore body. The Group accounts for stripping activities as follows:

### Development stripping costs

These are initial overburden removal costs incurred to obtain access to mineral deposits that will be commercially produced. These costs are capitalised when it is probable that future economic benefits (access to mineral ores) will flow to the Group and costs can be measured reliably.

Once the production phase begins, capitalised development stripping costs are depreciated using the units of production method based on the proven and probable reserves of the relevant identified component of the ore body which the initial stripping activity benefits.

### Production stripping costs

These are post initial overburden removal costs incurred during the normal course of production activity, which commences after the first saleable minerals have been extracted from the component. Production stripping costs can give rise to two benefits, the accounting for which is outlined below:

	<b>Production stripping activity</b>	
<b>Benefits of stripping activity</b>	Extraction of ore (inventory) in current period.	Improved access to future ore extraction.
<b>Period benefited</b>	Current period	Future period(s)
<b>Recognition and measurement criteria</b>	When the benefits of stripping activities are realised in the form of inventory produced; the associated costs are recorded in accordance with the Group's inventory accounting policy.	When the benefits of stripping activities are improved access to future ore; production costs are capitalised when all the following criteria are met: <ul style="list-style-type: none"><li>• the production stripping activity improves access to a specific component of the ore body and it is probable that economic benefits arising from the improved access to future ore production will be realised</li><li>• the component of the ore body for which access has been improved can be identified</li><li>• costs associated with that component can be measured reliably</li></ul>
<b>Allocation of costs</b>	Production stripping costs are allocated between the inventory produced and the production stripping asset using a life-of-component waste-to-ore (or mineral contained) strip ratio. When the current strip ratio is greater than the estimated life-of-component ratio a portion of the stripping costs is capitalised to the production stripping asset.	
<b>Asset recognised from stripping activity</b>	Inventory	Other mineral assets within property, plant and equipment.
<b>Depreciation basis</b>	Not applicable	On a component-by-component basis using the units of production method based on proven and probable reserves.

### Key judgements and estimates

*Judgements:* Judgement is applied by management in determining the components of an ore body.

*Estimates:* Estimates are used in the determination of stripping ratios and mineral reserves by component. Changes to estimates related to life-of-component waste-to-ore (or mineral contained) strip ratios and the expected ore production from identified components are accounted for prospectively and may affect depreciation rates and asset carrying values.

### Depreciation

Depreciation of assets, other than land, assets under construction and capitalised exploration and evaluation that are not depreciated, is calculated using either the straight-line (SL) method or units of production (UoP) method, net of residual values, over the estimated useful lives of specific assets. The depreciation method and rates applied to specific assets reflect the pattern in which the asset's benefits are expected to be used by the Group. The Group's proved and probable reserves for minerals assets are used to determine UoP depreciation unless doing so results in depreciation charges that do not reflect the asset's useful life. Where this occurs, alternative approaches to determining reserves are applied, to provide a phasing of periodic depreciation charges that better reflects the asset's expected useful life.

Where assets are dedicated to a mine lease, the useful lives below are subject to the lesser of the asset category's useful life and the life of the mine lease, unless those assets are readily transferable to another productive mine.

Assets classified as held for sale are measured at the lower of their carrying amount and fair value less cost to sell and therefore not depreciated.

## Key estimates

The determination of useful lives, residual values and depreciation methods involves estimates and assumptions and is reviewed annually. Any changes to useful lives or any other estimates or assumptions, including the expected impact of climate change and the transition to a lower carbon economy, may affect prospective depreciation rates and asset carrying values. The table below summarises the principal depreciation methods and rates applied to major asset categories by the Group.

Category	Buildings	Plant and equipment	Mineral rights	Capitalised exploration, evaluation and development expenditure
Typical depreciation methodology	SL	SL	UoP	UoP
Depreciation rate	25-50 years	3-30 years	Based on the rate of depletion of reserves	Based on the rate of depletion of reserves

## Commitments

The Group's commitments for capital expenditure were US\$5,958 million as at 30 June 2024 (2023: US\$3,975 million). The Group's commitments related to leases are included in note 22 'Leases'.

## 12 Intangible assets

	2024			2023		
	Goodwill US\$M	Other intangibles US\$M	Total US\$M	Goodwill US\$M	Other intangibles US\$M	Total US\$M
<b>Net book value</b>						
At the beginning of the financial year	1,389	221	1,610	1,197	172	1,369
Additions	–	101	101	–	51	51
Acquisition of subsidiaries and operations <sup>1</sup>	–	–	–	192	–	192
Amortisation for the year	–	(107)	(107)	–	(94)	(94)
Impairments for the year <sup>2</sup>	(50)	(7)	(57)	–	(2)	(2)
Disposals	–	(12)	(12)	–	(15)	(15)
Divestment of subsidiaries and operations <sup>3</sup>	–	(45)	(45)	–	–	–
Transfers and other movements	2	226	228	–	109	109
<b>At the end of the financial year</b>	<b>1,341</b>	<b>377</b>	<b>1,718</b>	<b>1,389</b>	<b>221</b>	<b>1,610</b>
– Cost	1,391	1,798	3,189	1,389	1,529	2,918
– Accumulated amortisation and impairments	(50)	(1,421)	(1,471)	–	(1,308)	(1,308)

<sup>1</sup> Relates to the acquisition of OZL on 2 May 2023. Refer to note 29 'Business combinations' for more information.

<sup>2</sup> Refer to note 13 'Impairment of non-current assets' for information on impairments.

<sup>3</sup> Relates to the divestment of the Blackwater and Daunia mines completed on 2 April 2024. Refer to note 3 'Exceptional items' for more information.

## Recognition and measurement

### Goodwill

Where the fair value of the consideration paid for a business acquisition exceeds the fair value of the identifiable assets, liabilities and contingent liabilities acquired, the difference is treated as goodwill. Goodwill is not amortised and is measured at cost less any impairment losses.

### Other intangibles

The Group capitalises amounts paid for the acquisition of identifiable intangible assets, such as software, licences and initial payments for the acquisition of mineral lease assets, where it is considered that they will contribute to future periods through revenue generation or reductions in cost. These assets, classified as finite life intangible assets, are carried in the balance sheet at the fair value of consideration paid (cost) less accumulated amortisation and impairment charges. Intangible assets with finite useful lives are amortised on a straight-line basis over their useful lives. The estimated useful lives are generally no greater than eight years.

Initial payments for the acquisition of intangible mineral lease assets are capitalised and amortised over the term of the permit. A regular review is undertaken of each area of interest to determine the appropriateness of continuing to carry forward costs in relation to that area. Capitalised costs are only carried forward to the extent that they are expected to be recovered through the successful exploitation of the area of interest or alternatively by its sale. To the extent that capitalised expenditure is no longer expected to be recovered, it is charged to the income statement.

Assets classified as held for sale are measured at the lower of their carrying amount and fair value less cost to sell and therefore not amortised.



### 13 Impairment of non-current assets

		2024			
Cash generating unit	Segment	Property, plant and equipment US\$M	Goodwill and other intangibles US\$M	Equity- accounted investment US\$M	Total US\$M
Western Australia Nickel	Group and unallocated	3,744	56	–	3,800
Other	Various	89	1	–	90
<b>Total impairment of non-current assets</b>		<b>3,833</b>	<b>57</b>	<b>–</b>	<b>3,890</b>
Reversal of impairment		–	–	–	–
<b>Net impairment of non-current assets</b>		<b>3,833</b>	<b>57</b>	<b>–</b>	<b>3,890</b>

		2023			
Cash generating unit	Segment	Property, plant and equipment US\$M	Goodwill and other intangibles US\$M	Equity- accounted investment US\$M	Total US\$M
Other	Various	73	2	–	75
<b>Total impairment of non-current assets</b>		<b>73</b>	<b>2</b>	<b>–</b>	<b>75</b>
Reversal of impairment		–	–	–	–
<b>Net impairment of non-current assets</b>		<b>73</b>	<b>2</b>	<b>–</b>	<b>75</b>

#### Recognition and measurement

Impairment tests for all non-financial assets (excluding goodwill) are performed when there is an indication of impairment. Goodwill is tested for impairment at least annually. Where the asset does not generate cash flows that are independent from other assets, the Group estimates the recoverable amount of the cash generating unit (CGU) to which the asset belongs, being the smallest identifiable group of assets that generates cash inflows that are largely independent of the cash inflows from other assets or groups of assets. If the carrying amount of the asset or CGU exceeds its recoverable amount, the asset or CGU is impaired and an impairment loss is charged to the income statement so as to reduce the carrying amount in the balance sheet to its recoverable amount.

Previously impaired assets (excluding goodwill as impairment losses are not reversed in subsequent periods) are reviewed for possible reversal of previous impairment at each reporting date. Impairment reversal cannot exceed the carrying amount that would have been determined (net of depreciation) had no impairment loss been recognised for the asset or CGU. Such reversal is recognised in the income statement. There were no reversals of impairment in the current or prior year.

#### How recoverable amount is calculated

The recoverable amount is the higher of an asset's or CGU's fair value less cost of disposal (FVLCD) and its value in use (VIU).

#### Fair value less cost of disposal

FVLCD is an estimate of the amount that a market participant would pay for an asset or CGU, less the cost of disposal. FVLCD for mineral assets is generally determined using independent market assumptions to calculate the present value of the estimated future post-tax cash flows expected to arise from the continued use of the asset, including the anticipated cash flow effects of any capital expenditure to enhance production or reduce cost, and its eventual disposal where a market participant may take a consistent view. Cash flows are discounted using an appropriate post-tax market discount rate to arrive at a net present value of the asset, which is compared against the asset's carrying value. FVLCD may also take into consideration other market-based indicators of fair value. FVLCD are based primarily on Level 3 inputs as defined in note 24 'Financial risk management' unless otherwise noted.

#### Value in use

VIU is determined as the present value of the estimated future cash flows expected to arise from the continued use of the asset in its present form and its eventual disposal or closure. VIU is determined by applying assumptions specific to the Group's continued use and cannot take into account future development. These assumptions are different to those used in calculating FVLCD and consequently the VIU calculation is likely to give a different result (usually lower) to a FVLCD calculation.

## Impairment of non-current assets (excluding goodwill)

Impairment of non-current assets relating to the year ended 30 June 2024 are detailed below.

### Western Australia Nickel

At 30 June 2024, the Group determined that the overall recoverable amount of the Western Australia Nickel CGU to be approximately negative US\$600 million including closure provisions. Considering the recoverable amount of individual assets within the CGU, this resulted in an aggregate impairment to property, plant and equipment of US\$3,744 million and intangible assets of US\$56 million in FY2024. The impairment is driven by oversupply in the global nickel market that has seen a sharp decline in forward nickel prices in the short to medium term, escalation in capital costs for Western Australia Nickel, and changes to development plans including the Group's decision, announced on 11 July 2024, to temporarily suspend Nickel West operations and the West Musgrave project at Western Australia Nickel. The Western Australia Nickel CGU is part of the 'Group and unallocated items' reportable segment.

The post-impairment carrying value of Western Australia Nickel property, plant and equipment is not material.

Recoverable amount used for the impairment assessment was determined using a fair value less costs of disposal methodology, applying discounted cash flow techniques utilising a post-tax real discount rate of 7.5 per cent. The valuation is most sensitive to changes in the long-term nickel price outlook and foreign exchange assumptions.

There were no material impairments of non-current assets for the year ended 30 June 2023.

### Impairment test for goodwill

The carrying amount of goodwill has been allocated to the CGUs, or groups of CGUs, as follows:

<b>Cash generating unit</b>	<b>2024</b>	<b>2023</b>
	<b>US\$M</b>	<b>US\$M</b>
Olympic Dam	–	1,010
OZ Minerals Limited provisional goodwill	–	192
Copper SA	<b>1,154</b>	–
Other	<b>187</b>	187
<b>Total goodwill</b>	<b>1,341</b>	<b>1,389</b>

For the purpose of impairment testing, goodwill has been allocated to CGUs or groups of CGUs, that are expected to benefit from the synergies of previous business combinations, which represent the level at which management will monitor and manage goodwill.

In previous reporting periods the Olympic Dam goodwill has been tested for impairment as part of the Olympic Dam CGU. In the current reporting period, and moving forward, the Olympic Dam goodwill has been tested for impairment at the Copper SA level, which comprises Olympic Dam, Carrapateena and Prominent Hill.

On 2 May 2023, the Group acquired OZ Minerals Limited (OZL) (refer to note 29 'Business combination' for details). In 2024 following the acquisition of OZL, the Group reorganised its reporting structure and established Copper SA, which comprises the Olympic Dam CGU as well as the acquired Carrapateena and Prominent Hill CGUs. On completion of the OZL business combination accounting, the OZL goodwill of US\$194 million was allocated as follows:

- US\$144 million to the Copper SA group of CGUs; and
- US\$50 million to Western Australia Nickel CGU, which was written off at 31 December 2023 as part of the impairment of Western Australia Nickel assets.

From FY2024, the Olympic Dam goodwill is tested for impairment as part of the Copper SA group of CGUs as this represents the level at which the Group now monitors and manages the goodwill.

Goodwill held by other CGUs is US\$187 million (2023: US\$187 million). This represents less than one per cent of net assets at 30 June 2024 (2023: less than one per cent). There was no impairment of other goodwill in the year to 30 June 2024 (2023: US\$ nil).

### Copper SA goodwill

<b>Impairment test conclusion</b>	The Group performed an impairment test of the Copper SA Group of CGUs, including goodwill, as at 30 June 2024 and an impairment charge was not required.
<b>How did the goodwill arise?</b>	Goodwill of US\$1,010 million and US\$144 million in relation to the acquisitions of WMC Resources Ltd (2005) and OZ Minerals Ltd (2023), respectively.
<b>Segment</b>	Copper SA is part of the Copper reportable segment.
<b>How were the valuations calculated?</b>	FVLCD methodology using DCF techniques has been applied in determining the recoverable amount of Copper SA.
<b>Significant assumptions and sensitivities</b>	<p>The valuation of Copper SA exceeded its carrying amount by approximately US\$8.4 billion and is most sensitive to changes in copper commodity price, production volumes, operating costs and discount rates.</p> <p>It is considered that there are no reasonably possible changes in these key assumptions that would, in isolation, result in the estimated recoverable amount being equal to the carrying amount. The valuation applied a post-tax real discount rate of 7.0 per cent.</p> <p>Key judgements and estimates that have been applied in the FVLCD valuation are disclosed further below.</p>

## Key judgements and estimates

*Judgements:* Assessment of indicators of impairment or impairment reversal and the determination of CGUs for impairment purposes require significant management judgement.

Indicators of impairment may include changes in the Group's operating and economic assumptions, including those arising from changes in reserves or mine planning, updates to the Group's commodity supply, demand and price forecasts, or the possible additional impacts from emerging risks including those related to climate change and the transition to a low-carbon economy.

### *Climate change*

The Group's impairment assessments may be impacted by climate change and the transition to a low-carbon economy. Further detail is provided in note 16 'Climate change'.

*Estimates:* The Group performs a recoverable amount determination for an asset or CGU when there is an indication of impairment or impairment reversal.

When the recoverable amount is measured by reference to FVLCD, in the absence of quoted market prices or binding sale agreement, estimates are made regarding the present value of future post-tax cash flows. These estimates are made from the perspective of a market participant and include prices, future production volumes, operating costs, capital expenditure, closure and rehabilitation costs, taxes, risk factors applied to cash flows and discount rates. The cash flow forecasts may include net cash flows expected from the extraction, processing and sale of material that does not currently qualify for inclusion in reserves. Reserves and resources are included in the assessment of FVLCD to the extent that it is considered probable that a market participant would attribute value to them.

When recoverable amount is measured using VIU, estimates are made regarding the present value of future cash flows based on internal budgets and forecasts and life of asset plans. Key estimates are similar to those identified for FVLCD, although some assumptions and values may differ as they reflect the perspective of management rather than a market participant.

All estimates require judgements and assumptions and are subject to risk and uncertainty that may be beyond the control of the Group; hence, there is a possibility that changes in circumstances will materially alter projections, which may impact the recoverable amount of an asset or CGU at each reporting date. With the exception of the Western Australia Nickel CGU impairment mentioned above, no indicators of impairment, or impairment reversal, were identified across the Group's remaining CGUs at 30 June 2024.

The significant estimates impacting the Group's recoverable amount determinations are:

### *Commodity prices*

Commodity prices were based on latest internal forecasts which assume short-term market prices will revert to the Group's assessment of long-term price. These price forecasts reflect management's long-term views of global supply and demand, built upon past experience of the commodity markets and are benchmarked with external sources of information such as analyst forecasts. Prices are adjusted based upon premiums or discounts applied to global price markers to reflect the location, nature and quality of the Group's production, or to take into account contracted prices.

### *Future production volumes*

Estimated production volumes were based on detailed data and took into account development plans established by management as part of the Group's long-term planning process. When estimating FVLCD, assumptions reflect all reserves and resources that a market participant would consider when valuing the respective CGU, which in some cases are broader in scope than the reserves that would be used in a VIU test. In determining FVLCD, risk factors may be applied to reserves and resources which do not meet the criteria to be treated as proved.

### *Cash outflows (including operating costs, capital expenditure, closure and rehabilitation costs and taxes)*

Cash outflows are based on internal budgets and forecasts and life of asset plans. Cost assumptions reflect management experience and expectations. Tax assumptions reflect existing and substantively enacted tax and royalty regimes and rates applicable in the jurisdiction of the CGU. In the case of FVLCD, cash flow projections include the anticipated cash flow effects of any capital expenditure to enhance production or reduce cost where a market participant may take a consistent view. VIU does not take into account future development.

### *Discount rates*

The Group uses real post-tax discount rates applied to real post-tax cash flows. The discount rates are derived using the weighted average cost of capital methodology. Adjustments to the rates are made for any risks that are not reflected in the underlying cash flows, including country risk.

## 14 Deferred tax balances

The movement for the year in the Group's net deferred tax position is as follows:

	2024	2023	2022
	US\$M	US\$M	US\$M
<b>Net deferred tax (liability)/asset</b>			
At the beginning of the financial year	(4,243)	(3,007)	(1,402)
Acquisition of subsidiaries and operations <sup>1</sup>	–	(867)	–
Income tax credit/(charge) recorded in the income statement <sup>2,3,4</sup>	988	(387)	(125)
Income tax (charge)/credit recorded directly in equity	(6)	6	(42)
Divestment of subsidiaries and operations <sup>5</sup>	(3)	–	(1,439)
Other movements	(1)	12	1
<b>At the end of the financial year</b>	<b>(3,265)</b>	<b>(4,243)</b>	<b>(3,007)</b>

<sup>1</sup> Relates to the acquisition of OZL on 2 May 2023. Refer to note 29 'Business combinations' for more information.

<sup>2</sup> Includes US\$1,125 million income tax credit in the year ended 30 June 2024 as a result of an impairment of Western Australia Nickel Assets.

<sup>3</sup> Includes US\$(283) million revaluation of deferred tax balances in the year ended 30 June 2023, following the substantive enactment of the Chilean Royalty Bill. Refer to note 3 'Exceptional items' for more information.

<sup>4</sup> Includes Discontinued operations income tax charge to the income statement in 2022 of US\$(61) million.

<sup>5</sup> Relates to the divestment of BMC and merger of Petroleum with Woodside in 2022. Refer to notes 3 'Exceptional items' and 28 'Discontinued operations' for more information.

For recognition and measurement refer to note 6 'Income tax expense'.

The composition of the Group's net deferred tax assets and liabilities recognised in the balance sheet and the deferred tax expense (credited)/charged to the income statement is as follows:

Type of temporary difference	Deferred tax assets		Deferred tax liabilities		(Credited)/charged to the income statement		
	2024	2023	2024	2023	2024	2023	2022
	US\$M	US\$M	US\$M	US\$M	US\$M	US\$M	US\$M
Depreciation <sup>1</sup>	(756)	(629)	5,221	6,259	(894)	452	554
Exploration expenditure	14	11	–	(1)	(2)	(2)	13
Employee benefits	23	27	(407)	(425)	6	(94)	20
Closure and rehabilitation	155	143	(1,770)	(1,753)	(29)	(296)	24
Resource rent tax	–	–	–	–	–	–	(129)
Other provisions	55	64	(196)	(210)	23	4	49
Deferred income	–	14	(23)	–	(9)	37	(31)
Deferred charges	(55)	(82)	522	644	(148)	85	7
Investments, including foreign tax credits	274	225	411	370	(6)	(54)	(298)
Foreign exchange gains and losses	(9)	(14)	80	190	(115)	42	33
Tax losses	364	276	(84)	(214)	40	37	28
Lease liability <sup>1</sup>	9	18	(730)	(767)	45	(83)	(10)
Other	(7)	3	308	206	101	259	(135)
<b>Total</b>	<b>67</b>	<b>56</b>	<b>3,332</b>	<b>4,299</b>	<b>(988)</b>	<b>387</b>	<b>125</b>

<sup>1</sup> Includes deferred tax associated with the recognition of right-of-use assets and lease liabilities on adoption of IFRS 16. Refer to note 22 'Leases'.

The composition of the Group's unrecognised deferred tax assets and liabilities is as follows:

	2024	2023
	US\$M	US\$M
<b>Unrecognised deferred tax assets</b>		
Tax losses and tax credits <sup>1</sup>	9,126	8,572
Investments in subsidiaries <sup>2</sup>	1,533	1,661
Mineral rights <sup>3</sup>	3,216	3,287
Other deductible temporary differences <sup>4</sup>	1,978	1,912
<b>Total unrecognised deferred tax assets</b>	<b>15,853</b>	<b>15,432</b>
<b>Unrecognised deferred tax liabilities</b>		
Investments in subsidiaries <sup>2</sup>	2,307	2,179
<b>Total unrecognised deferred tax liabilities</b>	<b>2,307</b>	<b>2,179</b>

<sup>1</sup> At 30 June 2024, the Group had income and capital tax losses with a tax benefit of US\$5,589 million (2023: US\$5,709 million) and tax credits of US\$3,537 million (2023: US\$2,863 million), which are not recognised as deferred tax assets, because it is not probable that future taxable profits or capital gains will be available against which the Group can utilise the benefits.

The gross amount of tax losses carried forward that have not been recognised is as follows:

Year of expiry	2024	2023
	US\$M	US\$M
<b>Income tax losses</b>		
Not later than one year	28	22
Later than one year and not later than two years	10	5
Later than two years and not later than five years	43	47
Later than five years and not later than 10 years	652	549
Later than 10 years and not later than 20 years	1,003	1,317
Unlimited	5,620	4,889
	<u>7,356</u>	<u>6,829</u>
<b>Capital tax losses</b>		
Not later than one year	–	–
Later than two years and not later than five years	–	–
Unlimited	13,494	13,870
<b>Gross amount of tax losses not recognised</b>	<u>20,850</u>	<u>20,699</u>
<b>Tax effect of total losses not recognised</b>	<u>5,589</u>	<u>5,709</u>

Of the US\$3,537 million of tax credits, US\$2,792 million expires not later than 10 years (2023: US\$2,405 million) and US\$745 million expires later than 10 years and not later than 20 years (2023: US\$458 million).

<sup>2</sup> The Group has deferred tax assets and deferred tax liabilities associated with undistributed earnings of subsidiaries that have not been recognised because the Group is able to control the timing of the reversal of the temporary differences and it is not probable that these differences will reverse in the foreseeable future. Where the Group has undistributed earnings held by associates and joint interests, the deferred tax liability will be recognised as there is no ability to control the timing of the potential distributions.

<sup>3</sup> The Group has deductible temporary differences relating to mineral rights for which deferred tax assets have not been recognised because it is not probable that future capital gains will be available against which the Group can utilise the benefits. The deductible temporary differences do not expire under current tax legislation.

<sup>4</sup> The Group has other deductible temporary differences for which deferred tax assets have not been recognised because it is not probable that future taxable profits will be available against which the Group can utilise the benefits. The deductible temporary differences do not expire under current tax legislation.

## 15 Closure and rehabilitation provisions

	<u>2024</u>	<u>2023</u>
	US\$M	US\$M
At the beginning of the financial year	9,887	8,689
Capitalised amounts for operating sites:		
Change in estimate	463	510
Exchange translation	(58)	(50)
Adjustments charged/(credited) to the income statement:		
Change in estimate	85	12
Exchange translation	(47)	(8)
Other adjustments to the provision:		
Amortisation of discounting impacting net finance costs	556	839
Acquisition of subsidiaries and operations <sup>1</sup>	–	168
Divestment of subsidiaries and operations <sup>2</sup>	(652)	–
Expenditure on closure and rehabilitation activities	(395)	(273)
Other movements	(2)	–
<b>At the end of the financial year</b>	<b>9,837</b>	<b>9,887</b>
Comprising:		
Current	610	520
Non-current	9,227	9,367
Operating sites	6,349	7,366
Closed sites	3,488	2,521

<sup>1</sup> Relates to the acquisition of OZL on 2 May 2023. Refer to note 29 'Business combinations' for more information.

<sup>2</sup> Relates to the divestment of the Blackwater and Daunia mines completed on 2 April 2024. Refer to note 3 'Exceptional items' for more information.

### Profile of closure and rehabilitation cash flows

The table below indicates the estimated profile of the Group's closure and rehabilitation provisions. The profile reflects the undiscounted forecast cash flows that underpin the provisions. In some instances, the Group has an obligation to rehabilitate and maintain a closed site for an indefinite period. For the purpose of this analysis, the cashflow period has been restricted to 100 years.

<b>Proportion of the Group's undiscounted forecast cashflows</b>	<b>2024</b>	<b>2023</b>
	%	%
In one year or less	3	3
In more than one year but not more than two years	3	4
In more than two years but not more than five years	8	8
In more than five years but not more than ten years	15	14
In more than ten years	71	71
<b>Total</b>	<b>100</b>	<b>100</b>

The Group is required to close and rehabilitate sites and associated facilities at the end of or, in some cases, during the course of production to a condition acceptable to the relevant authorities, as specified in licence requirements and the Group's closure performance requirements.

The key components of closure and rehabilitation activities are:

- the removal of all unwanted infrastructure associated with an operation
- the return of disturbed areas to a safe, stable and self-sustaining condition, consistent with the agreed post-closure land use

### Recognition and measurement

Provisions for closure and rehabilitation are recognised by the Group when:

- it has a present legal or constructive obligation as a result of past events
- it is more likely than not that an outflow of resources will be required to settle the obligation
- the amount can be reliably estimated

### **Initial recognition and measurement**

Closure and rehabilitation provisions are initially recognised when an environmental disturbance first occurs. The individual site provisions are an estimate of the expected value of future cash flows required to close the relevant site using current standards and techniques and taking into account risks and uncertainties. Individual site provisions are discounted to their present value using currency specific discount rates aligned to the estimated timing of cash outflows.

When provisions for closure and rehabilitation are initially recognised, the corresponding cost is capitalised as an asset, representing part of the cost of acquiring the future economic benefits of the operation.

### **Subsequent measurement**

The closure and rehabilitation asset, recognised within property, plant and equipment, is depreciated over the life of the operations. The value of the provision is progressively increased over time as the effect of discounting unwinds, resulting in an expense recognised in net finance costs.

The closure and rehabilitation provision is reviewed at each reporting date to assess if the estimate continues to reflect the best estimate of the obligation. If necessary, the provision is remeasured to account for factors such as:

- additional disturbance during the period
- revisions to estimated reserves, resources and lives of operations including any changes to expected operating lives arising from the Group's latest assessment of the potential impacts of climate change and the transition to a low-carbon economy
- developments in technology
- changes to regulatory requirements and environmental management strategies
- changes in the estimated extent and costs of anticipated activities, including the effects of inflation and movements in foreign exchange rates
- movements in interest rates affecting the discount rate applied

Changes to the closure and rehabilitation estimate for operating sites are added to, or deducted from, the related asset and amortised on a prospective basis over the remaining life of the operation, generally applying the units of production method.

Costs arising from unforeseen circumstances, such as the contamination caused by unplanned discharges, are recognised as an expense and liability when the event gives rise to an obligation that is probable and capable of reliable estimation.

For personal use only

## Closed sites

Where future economic benefits are no longer expected to be derived through operation, changes to the associated closure and remediation costs are charged to the income statement in the period identified. This amounted to US\$38 million in the year ended 30 June 2024 (2023: US\$4 million; 2022: US\$74 million).

### Key estimates

Closure cost estimates are generally based on conceptual level studies early in the operating life of an asset with more detailed studies and planning performed as closure risks (including those related to climate change) are identified and/or as an asset, or parts thereof, near closure. As such, the recognition and measurement of closure and rehabilitation provisions requires the use of significant estimates and assumptions, including, but not limited to:

- the extent (due to legal or constructive obligations) of potential activities required for the removal of infrastructure, decharacterisation of tailings storage facilities and rehabilitation activities
- costs associated with future closure activities
- the extent and period of post-closure monitoring and maintenance, including water management
- applicable discount rates
- the timing of cash flows and ultimate closure of operations

The extent, cost and timing of future closure activities may also be impacted by the potential physical impacts of climate change and the transition to a low-carbon economy. Further detail is provided in note 16 'Climate change'.

Estimates for post-closure monitoring and maintenance reflect the Group's strategies for individual sites, which may include possible relinquishment. The period of monitoring and maintenance included in the provision requires judgement and considers regulatory and licencing requirements, the outcomes of studies and management's current assessment of stakeholder expectations.

While progressive closure is performed across a number of operations, significant activities are generally undertaken at the end of the production life at the individual sites, the estimated timing of which is informed by the Group's current assumptions relating to demand for commodities and carbon pricing, and their impact on the Group's long-term price forecasts.

Approximately 52 per cent (2023: 51 per cent) of the Group's total undiscounted forecast cashflows are expected to be incurred after more than 30 years, reflecting the long-lived nature of many of the Group's operations which have remaining production lives ranging from 5-87 years (2023: 1-103 years). The discount rates applied to the Group's closure and rehabilitation provisions are determined by reference to the currency of the closure cash flows, the period over which the cash flows will be incurred and prevailing market interest rates (where available). The discount rates applied to the Group's closure and rehabilitation provisions were revised during the year to reflect increases in market interest rates. The effect of changes to discount rates was a decrease of approximately US\$336 million in the closure and rehabilitation provision of which US\$167 million in respect of closed sites was recognised in the income statement.

While the closure and rehabilitation provisions reflect management's best estimates based on current knowledge and information, further studies, trials and detailed analysis of relevant knowledge and resultant closure activities for individual assets continue to be performed throughout the life of asset. Such studies and analysis can impact the estimated costs of closure activities. Estimates can also be impacted by the emergence of new closure and rehabilitation techniques, changes in regulatory requirements and stakeholder expectations for closure (including costs associated with equitable transition), development of new technologies, risks relating to climate change and the transition to a low-carbon economy, and experience at other operations. These uncertainties may result in future actual expenditure differing from the amounts currently provided for in the balance sheet.

### Sensitivity

A 0.5 per cent increase in the discount rates applied at 30 June 2024 would result in a decrease to the closure and rehabilitation provision of approximately US\$665 million, a decrease in property, plant and equipment of approximately US\$457 million in relation to operating sites and an income statement credit of approximately US\$208 million in respect of closed sites. In addition, the change would result in a decrease of approximately US\$23 million to depreciation expense and a US\$21 million increment in net finance costs due to unwind of discount for the year ending 30 June 2025.

Given the long-lived nature of the majority of the Group's assets, the majority of final closure activities are generally not expected to occur for a significant period of time.

However, a one-year acceleration in forecast cash flows of the Group's closure and rehabilitation provisions, in isolation, would result in an increase to the provision of approximately US\$231 million, an increase in property, plant and equipment of US\$148 million in relation to operating sites and an income statement charge of US\$83 million in respect of closed sites.



## 16 Climate change

The Group recognises that warming of the climate is unequivocal, the human influence is clear and physical impacts are unavoidable. Identifying, monitoring and assessing the actual and potential impacts of climate change is complex and the Group continues to develop its assessment of the actual and potential financial impacts of climate-related risks (threats and opportunities), including the transition to a net zero economy and physical risk impacts.

The Group's current climate change strategy focuses on:

- building a portfolio to support the megatrends shaping our world, including future-facing commodities (copper, nickel and potash) and steelmaking materials (iron ore and steelmaking coal)
- reducing operational (Scopes 1 and 2 from operated assets) greenhouse gas (GHG) emissions
- investing in low to zero GHG emissions technologies
- supporting Scope 3 GHG emissions reductions in the Group's value chain and promoting product stewardship
- managing climate-related risks
- working with others to enhance the global policy and market response

Areas of these Financial Statements that may be impacted in connection with this strategy throughout the value creation and delivery cycle of the Group's operations, include:

Phase	Areas of potential Financial Statement impact
Exploration and acquisition	<ul style="list-style-type: none"> <li>• Financial impact of portfolio decisions</li> </ul>
Development and mining / Process and logistics	<ul style="list-style-type: none"> <li>• Impact of transition risks on asset carrying values</li> <li>• Physical climate-related risks and asset carrying values</li> <li>• Application of carbon pricing assumptions and acquisition of carbon credits</li> <li>• Useful economic lives of property, plant and equipment</li> <li>• Expenditure on operational (Scopes 1 and 2 from operated assets) decarbonisation</li> </ul>
Sales, marketing and procurement	<ul style="list-style-type: none"> <li>• Expenditure to support value chain (Scope 3) decarbonisation</li> </ul>
Closure and rehabilitation	<ul style="list-style-type: none"> <li>• Timing, scope and expected cost of closure and rehabilitation activities</li> </ul>

At the date of issue of these Financial Statements, indicators show the appropriate measures are not in place globally to drive decarbonisation at the pace or scale required to achieve the aim of the Paris Agreement to limit the global average temperature increase to 1.5°C above pre-industrial levels. The significant judgements and key estimates used in the preparation of these Financial Statements reflect the Group's current planning range (which implies a projected global average temperature increase of approximately 2°C by CY2100), as described below.

While not the basis of preparation of these Financial Statements, the Group continues to perform sensitivity analysis under the Group's 1.5°C scenario to consider potential Financial Statement impacts of commodity and carbon prices in a rapidly decarbonising world. The Group's 1.5°C scenario is not a forecast of what is likely to occur.

Future changes to the Group's climate change strategy or global decarbonisation trends may impact the Group's significant judgements and key estimates, and result in material changes to financial results, cash flows and the carrying values of certain assets and liabilities in future reporting periods.

### Financial impact of portfolio decisions

Over recent years, the Group has repositioned its portfolio towards commodities that can help enable and support the megatrends of decarbonisation and electrification, urbanisation and population growth. Refer to note 2 'Revenue', which presents current and prior year revenue by commodity. Key portfolio changes the Group has made in FY2024 include:

- sanctioning of the Jansen Stage 2 potash investment (following approval of Jansen Stage 1 in FY2022)
- further consolidation of the Group's steelmaking coal portfolio to concentrate on the higher-quality (grade) coals (which enable steelmakers to be more efficient and operate with a lower GHG emissions intensity) through the divestment of Blackwater and Daunia mines from the BHP Mitsubishi Alliance (BMA) (following the divestment of the Group's interest in BHP Mitsui Coal in FY2022)

In recent years, the Group also:

- completed the acquisition of OZ Minerals in FY2023 to support the creation of a South Australia copper basin
- completed the divestment of the Group's Petroleum business through its merger with Woodside in FY2022
- divested the Group's interest in the Cerrejón non-operated energy coal joint venture in FY2022

Also in FY2022, the Group announced that it would retain New South Wales Energy Coal (NSWEC) in its portfolio, seek the relevant approvals to continue mining beyond the current consent that expires at the end of FY2026 and proceed with a managed process to cease mining at the asset by the end of FY2030.

Following impairments recognised in previous periods, the net carrying value of NSWEC at 30 June 2024 is approximately negative US\$200 million comprising property, plant and equipment (PP&E) of approximately US\$540 million and closure provisions and other liabilities of approximately US\$740 million. As at 30 June 2024, the potential exposure to further impairment for NSWEC is limited to the book value of PP&E of US\$540 million, with the forecast cash flows over the proposed operating period supporting the current carrying value. Further, the useful lives of NSWEC PP&E do not exceed the remaining proposed operating period.

In July 2024, the Group announced that the Nickel West operations and West Musgrave project (Western Australia Nickel) would be temporarily suspended from October 2024. Refer to note 13 'Impairment of non-current assets' for further details.

### Impact of transition risks on asset carrying values

Significant judgements and key estimates in relation to the preparation of these Financial Statements, including asset carrying values and impairment assessments, are impacted by the Group's current assessment of the range of economic and climate-related conditions that could exist in the world's transition to a net zero economy, considering the current trajectory of society and the global economy as a whole.

For example, demand for the Group's commodities may decrease due to policy, regulatory (including carbon pricing mechanisms), legal, technological, market or societal responses to climate change, resulting in a proportion of a cash generating unit's (CGU) reserves becoming incapable of extraction in an economically viable fashion. Alternatively, technological or market developments increasing demand for commodities in the portfolio that help enable decarbonisation may have a positive impact on prices for those commodities.

The Group has developed three unique planning cases which comprise the Group's planning range: a 'most likely' base case, used as the basis for judgements and assumptions in these Financial Statements, and an upside case and downside case that provide the range's boundaries. The three cases reflect proprietary forecasts for the global economy and associated sub-sectors (i.e. energy, transport, agriculture and steel) and the resulting market outlook for the Group's core commodities.

Given the complexity and inherent uncertainty of long run forecasting, these pathways are reviewed periodically to reflect new information, with a process in place to assess the need to update internal long-term price outlooks for developments in the periods between pathway updates.

The Group reflects the planning range and associated price outlooks in the internal valuations used as the basis for the Group's impairment assessments.

The discount rate used in the internal valuations reflects a real post-tax weighted average cost of capital (WACC), including country and state risk premia where appropriate, and ranges from 7.0 per cent to 9.5 per cent across the Group (2023: 7.0 per cent to 9.5 per cent). Cash flow forecasts used as the basis for impairment testing include asset specific risks, including climate-related risks such as operational interruptions as a result of physical climate-related risks, and therefore the Group does not include a separate climate-related risk adjustment in the Group's WACC.

Further detail on the Group's significant judgements and estimates that inform the planning range and FY2024 impairment assessments, is included in note 13 'Impairment of non-current assets'.

In addition to the planning range, and as described below in 'Paris Agreement and 1.5°C scenarios', the Group uses its 1.5°C scenario, which implies a global average temperature increase of 1.5°C by CY2100, to test resilience of the Group's portfolio in a rapidly decarbonising world.

### Physical climate-related risks and asset carrying values

The Group's operations are exposed to physical climate-related risks. In FY2024, the Group continued to progress studies of physical climate-related risks to better understand the potential impacts on safety, productivity and cost, with the work to continue in FY2025.

The studies consider potential impacts of acute and chronic risks from material climate hazards, which differ based on an operated asset's geographic region, asset infrastructure and operational processes. The studies are ongoing and therefore the Group's consideration of physical climate-related risks, including factors such as potential operational interruptions caused by extreme weather events, therefore includes only the Group's current best estimates of related potential financial impacts.

Given the complexity of physical climate-related risk modelling and the status of the Group's ongoing physical risk assessment process, the identification of additional risks and/or the detailed development of the Group's response may result in material changes to financial results and the carrying values of assets and liabilities in future reporting periods.

### Application of carbon pricing assumptions and acquisition of carbon credits

The Group's carbon credits and offsetting strategy is managed at the Group level. However, investment decisions and asset valuations used for the purposes of impairment testing consider carbon price assumptions in relevant regions by applying a carbon price to estimated unmitigated Scopes 1 and 2 GHG emissions over the life of the respective operation.

In determining the Group's strategy and carbon price forecast, factors including a country's current and announced climate policies, targets and societal factors, such as public acceptance and demographics, are considered. As at the date of these Financial Statements, the carbon price used in asset valuations reflects the following ranges:

US\$ real (July 2024) per tCO <sub>2</sub> -e	FY2030	FY2030	FY2050	FY2050
	Low	High	Low	High
Australia	28	83	166	248
Brazil	6	55	138	221
Chile	9	44	166	248
Canada	71	110	221	248
Key customer countries <sup>1</sup>	1	193	28	276

The Group currently acquires carbon credits primarily for regulatory purposes. The Group's plan is to achieve its FY2030 operational (Scopes 1 and 2 from operated assets) GHG emissions target through structural abatement, but if there is an unanticipated shortfall in the pathway to achieve the target, there may be a need to surrender voluntary carbon credits to close the performance gap. The Group will not use regulatory carbon credits when determining whether it has achieved its FY2030 target. The Group may also sell carbon credits, depending on internal use requirements, or originate carbon credits through project development or direct investment.

<sup>1</sup> Maximum low and high values found across China, India, European Union, United States, Japan, Korea, Indonesia, South Africa, Other Latin and Central America and Other Asia.

Acquired carbon credits are recognised as an asset initially at cost and are subsequently subject to impairment and/or net realisable value assessments. Classification of the asset reflects the intended manner of use:

- Inventory – where the intended use is uncertain or the carbon credit is available for trading purposes (either separately or ‘bundled’ with sale of a commodity); or
- Intangible asset – held for regulatory or voluntary surrender

Obligations arising from greenhouse gas emission schemes, such as the Australian Safeguard Mechanism (which requires its largest industrial facilities to surrender eligible carbon credits when their Scope 1 GHG emissions exceed a progressively declining legislated limit, known as the baseline) are recognised as a liability at the reporting date when the Group has an obligation.

During FY2024, the Group surrendered approximately US\$1 million in carbon credits (~47,000 tCO<sub>2</sub>-e) to satisfy Australian assets’ FY2023 Safeguard Mechanism obligations. There were no voluntary surrenders.

As at 30 June 2024, the Group recognised:

- Approximately US\$23 million in carbon credits within intangible assets (with no carbon credits classified as inventory).
- An obligation of US\$17 million, representing the FY2024 requirement to surrender eligible carbon credits under the Safeguard Mechanism. The Group intends to satisfy this liability through the surrender of carbon credits in FY2025.

### **Useful economic lives of property, plant and equipment**

The determination of useful lives of the Group’s PP&E requires judgement, including consideration of the Group’s climate change strategy, targets and goals, decarbonisation plans and the possible impact of transition risks on demand for the Group’s commodities.

Useful lives are reviewed each reporting period, including to ensure they do not exceed the remaining expected operating life of the operation in which they are utilised. The remaining lives of the Group’s operations reflect the Group’s planning range and its underlying climate-related assumptions.

A key component of the Group’s operational decarbonisation strategy is the displacement of diesel within the Group’s operations, particularly the haul truck fleet. The Group is supporting the development of new equipment by original equipment manufacturers, including entering into partnerships focused on the development and trialling of electric locomotives and haul trucks.

While technical and commercial development of the technology needed is progressing, the Group’s operational plans generally assume replacement of haul trucks, and other diesel powered equipment, at the end of their useful lives in line with the Group’s regular fleet renewal programs. For example, a significant proportion of the Group’s existing WAIO mining fleet is due for replacement prior to the expected availability of battery electric vehicle solutions. As such, the Group’s decarbonisation plans have not had a material impact on the estimated remaining useful lives of the Group’s existing fleet of assets in FY2024.

### **Expenditure on operational (Scopes 1 and 2 from operated assets) decarbonisation**

The Group set a medium-term target to reduce its operational GHG emissions (Scopes 1 and 2 from operated assets) by at least 30 per cent from the Group’s FY2020 baseline levels by FY2030 and a long-term goal to achieve net zero operational GHG emissions by CY2050. The FY2020 baseline for the medium-term target and subsequent performance is adjusted for acquisitions, divestments and methodology changes.

While the Group’s operational GHG emissions increased in FY2024, compared to FY2023, largely as emissions from organic growth exceeded reductions from decarbonisation activities, the Group remains on track to meet its FY2030 target. Operational decarbonisation activities during FY2024 continued to focus on transitioning the Group’s electricity supply to renewable sources and continuing to progress projects in relation to displacement of diesel. Expenditure in relation to diesel displacement and fugitive methane is expected to increase towards the second half of the decade, with capital expenditure in these areas not material in FY2024.

A significant proportion of the Group’s renewable electricity is currently sourced through power purchase agreements and judgement is required in determining the appropriate accounting treatment of such arrangements. Depending on the specific terms and conditions, power purchase agreements may be recognised as an expense when incurred, a financial derivative or a lease liability, with an associated right of use asset.

In addition to operational expenditure on renewable energy, the Group recognised the following in relation to power purchase agreements at 30 June 2024:

- US\$44 million of lease liabilities, with associated right of use assets (2023: US\$ nil)
- financial derivatives with a fair value of approximately US\$92 million (2023: US\$50 million)

Estimated future cash flows for the Group’s assets include amounts associated with projects aimed at contributing to the achievement of the Group’s medium-term target and long-term goal. These cash flow estimates form the basis of the Group’s impairment assessments as outlined in further detail in note 13 ‘Impairment of non-current assets’.

The Group estimates up to US\$4 billion (nominal terms) in spend and commitments over the decade to FY2030 to execute the Group's operational decarbonisation plans. This amount incorporates capital expenditure and lease commitments that were previously expected to be classified as capital expenditure and reflects the incremental cost to facilitate the Group's reduction in operational GHG emissions (e.g. the additional cost of buying or leasing an electric truck versus the diesel combustion truck it would replace).

Many of the projects planned to commence before FY2030 are likely to extend beyond the Group's medium-term target period and are expected to make a substantial contribution towards the Group's long-term goal of net zero operational GHG emissions by CY2050. Significant expenditure on fleet renewal at certain assets, for example Olympic Dam, is expected to occur after FY2030.

As the Group's climate response is further integrated into business-as-usual planning, the spending on climate initiatives is expected to increasingly form part of ordinary course business expenditures.

Any change to the Group's climate change strategy and future cash flows could impact the expected level of expenditure on operational decarbonisation and the associated Financial Statement significant judgements and key estimates.

#### **Expenditure to support value chain (Scope 3) decarbonisation**

The Group continues to invest, including through partnership with others, in potential GHG emissions reduction opportunities in its value chain through technology innovation and development to support GHG emissions reductions by steelmaking customers and in the maritime industry.

However, while the Group seeks to influence reduction opportunities, Scope 3 emissions occur outside of the Group's direct control. Reduction pathways are dependent on the development, and upstream or downstream deployment of, solutions and/or supportive policy and improvements in Scope 3 emissions measurement. Where possible, the financial impact of the Group's activities in support of the development of Scope 3 emissions reduction pathways is reflected in these Financial Statements. In FY2024, this included expenditure of approximately US\$30 million to support collaborative partnerships, consortiums, research and development and BHP Ventures investments.

Given the inherent uncertainty in future technology and policy advancements, it is not currently possible to reliably estimate or measure the full potential Financial Statement impacts of the Group's pursuit of its Scope 3 goals and targets.

#### **Timing, scope and expected cost of closure and rehabilitation activities**

The extent, timing and cost of the Group's future closure activities may be impacted by potential physical and transition climate-related impacts. In estimating the potential cost of closure activities, the Group considers factors such as long-term weather outlooks, for example forecast changes in rainfall patterns. Closure cost estimates also consider the impact of the Group's climate change strategy on the costs and timing of performing closure activities and the impact of new technology where appropriately developed and tested. For example, closure cost estimates largely continue to reflect the use of existing fuel sources for the Group's equipment while the Group continues to invest in the development of alternative fuel sources and fleet electrification.

The estimated cost of closure activities includes management's current best estimate in relation to post-closure monitoring and maintenance, which may be required for significant periods beyond the completion of other closure activities and is therefore exposed to potential long-term climate-related impacts. While reflecting management's current best estimate, the cost of post-closure monitoring and maintenance may change in future reporting periods as the understanding of, and potential long-term impacts from a changing climate continue to evolve.

Given the long-lived nature of the majority of the Group's assets, the majority of final closure activities are not expected to occur for a significant period of time. However:

- Acknowledging the wide range of potential energy transition impacts for steelmaking coal demand and the impact of any significant changes in demand on mine lives, for illustrative purposes only, a one-year change in the mine life of the Group's steelmaking coal assets would, in isolation, change the closure and rehabilitation provisions for those assets by approximately US\$40 million.
- The Group announced in FY2022 the planned closure of NSWEC by FY2030. As such, while the provision is subject to estimation and assumptions, the timing of closure is no longer considered materially susceptible to potential long-term climate-related transition risks.

Further, while the Group is evaluating the approach to the closure of NSWEC and potential expenditure relating to an equitable change and transition for its workforce, the Group continues to engage with its employees and the community to understand and develop the most appropriate transition plan. As the Group's approach is currently under development with impacted parties, it is not yet supported by a detailed, formal plan or commitment and therefore no provision relating to equitable change and transition costs can be recognised as at 30 June 2024.

More detail on the key judgements and estimates impacting the Group's closure and rehabilitation provisions is presented in note 15 'Closure and rehabilitation provisions'.

#### **Paris Agreement and 1.5°C scenarios**

The Group acknowledges that there are a range of energy transition scenarios, including those that are aligned with the goals of the Paris Agreement, that may indicate different outcomes for individual commodities. As noted, indicators show the appropriate measures are not in place globally to drive decarbonisation pathways at a pace or scale required to limit the global average temperature increase to 1.5°C above pre-industrial levels (particularly in hard-to-abate sectors, like steelmaking). However, to the extent governments, institutions, companies, and society increasingly focus on addressing climate change, the potential for a non-linear and/or more rapid transition trajectory increases.

Accordingly, in addition to the Group's planning range, which implies a projected global average temperature increase of around 2°C by CY2100, the Group utilises a range of scenarios, including a 1.5°C scenario, when testing the resilience of its portfolio and major investment decisions. In FY2024, the Group developed a new 1.5°C scenario, which does not currently inform the Group's planning range and intentionally uses aggressive assumptions around political, technological and behavioural change, particularly for hard-to-abate sectors, such as steelmaking. It is designed to specifically test the Group's current portfolio following changes to its portfolio since the Group's previous 1.5°C scenario published in the BHP Climate Change Report 2020.

The Group's 1.5°C scenario is not a forecast of what is likely to occur and represents one of many hypothetical pathways for the future based on different assumptions relating to world-wide economies, including global energy systems. While the Group does not currently see a 1.5°C outcome as likely, a 1.5°C scenario is utilised to inform the Group's understanding of the potential impacts of an acceleration in global decarbonisation. All 1.5°C scenarios require steep global annual GHG emission reductions, sustained for decades, to stay within a 1.5°C carbon budget (i.e. the total net amount of GHG emissions that can be emitted worldwide to limit global average temperature increase to 1.5°C by CY2100).

The Group continues to monitor global decarbonisation signposts and updates its planning range, associated price outlooks and cost of carbon assumptions. If such signposts indicate the appropriate measures are in place for achievement of a 1.5°C outcome, this will be reflected in the Group's planning range.

#### *Capital allocation*

The Group includes a 1.5°C scenario sensitivity in capital allocation processes, which compares the demand outlook for the Group's products in the planning range to that of a rapidly decarbonising global economy, should that eventuate.

Consideration of the Group's 1.5°C scenario in the capital allocation process is intended to test resilience of the Group's portfolio and mitigate the risk of stranded assets, and associated impairments, should global measures to achieve a 1.5°C outcome be adopted.

#### *Demand for the Group's commodities*

The Group acknowledges that there are a range of possible energy transition scenarios, including those that are aligned with the aims of the Paris Agreement, that may indicate different outcomes for individual commodities. The Group examines the resilience of its portfolio to a 1.5°C scenario (the Group's 1.5°C scenario) by considering the impact of the commodity and carbon prices under that scenario using the Group's latest operating plans.

There are inherent limitations with scenario analysis and it is difficult to predict which, if any, of the range of scenarios the Group utilises might eventuate and none of the scenarios considered constitutes a definitive outcome for the Group. The Group's 1.5°C scenario has a distinct impact on each of its commodities with current trends impacting the degree of likelihood of future outcomes aligning with different elements of the scenario. However, based on current trends, it is considered unlikely that the Group's 1.5°C scenario would occur.

As the electrification megatrend is well underway, there is a higher likelihood of a positive impact to demand reflected in the Group's 1.5°C scenario eventuating for commodities which stand to benefit from this megatrend, including copper, nickel and uranium.

The Group's 1.5°C pathway for potash is driven by increasing competition for land and the need for agricultural productivity.

The long-term commodity prices for potash, copper, nickel and uranium under the Group's 1.5°C scenario are favourable to or materially consistent with the price outlooks from the base case of the Group's planning range. Price-only sensitivities using the prices derived from the Group's 1.5°C scenario do not indicate an illustrative impairment for those commodities.

However, the global steelmaking sector, like many hard-to-abate sectors, is not currently seeing the investment, policy settings or technological progress needed to align with the trajectory in the Group's 1.5°C scenario. The Group's 1.5°C scenario assumes an aggressive decarbonisation pathway for the steelmaking sector as a result of increased scrap collection, progression or acceleration of currently challenging, evolving or early-stage decarbonisation technologies and top-down government policies. The current signposts do not indicate progress in line with this trajectory.

While GHG emissions intensity of steel production reduces significantly in the Group's 1.5°C scenario, underlying demand for steel (including the proportion from ore-based steel production) remains strong. As such, the price derived from the Group's 1.5°C scenario for iron ore remains materially aligned with the Group's base case assumptions and does not indicate an illustrative impairment.

The assumptions within the Group's 1.5°C scenario result in a greater relative impact to steelmaking coal prices, compared to the base case assumptions. Under the Group's base case assumptions within the planning range, headroom in excess of US\$6 billion exists between the carrying value of the Group's steelmaking coal assets and their estimated valuation. In a price-only sensitivity, using the prices derived from the Group's 1.5°C scenario, while current headroom would reduce, no illustrative impairment of the Group's steelmaking coal assets is indicated.

In addition, to provide further analysis of the risk of potential impairment in a 1.5°C scenario, the Group has also performed a price-only sensitivity for steelmaking coal assets under a 1.5°C scenario published by Wood Mackenzie, a research and consultancy business for the global energy, power and renewables, subsurface, chemicals and metals and mining industries. This further analysis acknowledges the wide range of potential energy transition impacts for steelmaking coal.

Under the Wood Mackenzie 1.5°C scenario, reflecting the prices outlined below, a price-only sensitivity would also reduce the current headroom on the Group's steelmaking coal assets, but does not indicate an illustrative impairment.

<b>Price source</b>	<b>CY2030 Price (real, US\$/tonne)</b>	<b>CY2050 Price (real, US\$/tonne)</b>
Wood Mackenzie Net Zero (1.5°C) Scenario (June 2024)	180	143

The Group considers that it is currently impracticable to fully assess all potential Financial Statement impacts in scenario analysis. Accordingly, these price-only sensitivities reflect different prices while assuming that all other factors in the asset valuations, such as production and sales volumes, capital and operating expenditures, carbon pricing and the discount rate, remain unchanged from those used in the Group's FY2024 impairment assessments. As such, the sensitivities do not attempt to assess all potential impacts, including those on asset valuations, that may arise under a 1.5°C scenario and do not consider any actions the Group would take in respect of operating and investment plans to mitigate the cash flow and valuation impacts that may arise in a 1.5°C scenario.

## Capital structure

### 17 Share capital

	BHP Group Limited			BHP Group Plc
	2024 shares	2023 shares	2022 shares	2022 shares
<b>Share capital issued</b>				
Opening number of shares	5,065,820,556	5,062,323,190	2,945,851,394	2,112,071,796
Issue of shares	5,710,261	3,497,366	4,400,000	–
Corporate structure unification <sup>1</sup>	–	–	2,112,071,796	(2,112,071,796)
Purchase of shares by ESOP Trusts	(5,687,667)	(6,442,571)	(8,704,669)	(63,567)
Employee share awards exercised following vesting	5,841,767	6,081,843	8,522,684	77,748
Movement in treasury shares under Employee Share Plans	(154,100)	360,728	181,985	(14,181)
<b>Closing number of shares</b>	<b>5,071,530,817</b>	<b>5,065,820,556</b>	<b>5,062,323,190</b>	<b>–</b>
Comprising:				
Shares held by the public	5,070,273,143	5,064,408,782	5,061,272,144	–
Treasury shares	1,257,674	1,411,774	1,051,046	–

<sup>1</sup> As a result of the corporate structure unification on 31 January 2022, 2,112,071,796 fully paid ordinary shares in BHP Group Limited were issued to BHP Group Plc shareholders in a one for one exchange of their BHP Group Plc ordinary shares, resulting in BHP Group Limited becoming the sole parent company of the Group with a single set of shareholders.

In August 2023, BHP Group Limited issued 2,919,231 fully paid ordinary shares to the BHP Group Limited Employee Equity Trust and Solium Capital (Australia) Pty Ltd at A\$43.52 per share (2023: 3,497,366 fully paid ordinary shares issued at A\$40.51 per share; 2022: 4,400,000 fully paid ordinary shares issued at A\$52.99 per share) and in March 2024, BHP Group Limited issued 2,791,030 fully paid ordinary shares to the BHP Group Limited Employee Equity Trust and Computershare Nominees CI Ltd at A\$43.79 per share to satisfy the vesting of employee share awards and related dividend equivalent entitlements under those employee share plans.

Share capital of BHP Group Limited at 30 June 2024 is composed of the following categories of shares:

#### Ordinary shares fully paid

Each fully paid ordinary share of BHP Group Limited carries the right to one vote at a meeting of the Company.

#### Treasury shares

Treasury shares are fully paid ordinary shares of BHP Group Limited that are held by the ESOP Trusts for the purpose of issuing shares to employees under the Group's Employee Share Plans. Treasury shares are recognised at cost and deducted from equity, net of any income tax effects. When the treasury shares are subsequently sold or reissued, any consideration received, net of any directly attributable costs and income tax effects, is recognised as an increase in equity. Any difference between the carrying amount and the consideration, if reissued, is recognised in retained earnings.

## 18 Other equity

	<u>2024</u>	<u>2023</u>	<u>2022</u>	<u>Recognition and measurement</u>
	US\$M	US\$M	US\$M	
Common control reserve	(1,603)	(1,603)	(1,603)	The common control reserve arose on unification of the Group's corporate structure and represents the residual on consolidation between BHP Group Ltd's investment in BHP Group Plc (now known as BHP Group (UK) Ltd) and BHP Group Plc's share capital, share premium and capital redemption reserve at the time of unification.
Employee share awards reserve	166	171	174	The employee share awards reserve represents the accrued employee entitlements to share awards that have been charged to the income statement and have not yet been exercised. Once exercised, the difference between the accumulated fair value of the awards and their historical on-market purchase price is recognised in retained earnings.
Cash flow hedge reserve	27	10	41	The cash flow hedge reserve represents hedging gains and losses recognised on the effective portion of cash flow hedges. The cumulative deferred gain or loss on the hedge is recognised in the income statement when the hedged transaction impacts the income statement, or is recognised as an adjustment to the cost of non-financial hedged items. The hedging reserve records the portion of the gain or loss on a hedging instrument in a cash flow hedge that is determined to be an effective hedge relationship.
Cost of hedging reserve	(7)	(1)	(19)	The cost of hedging reserve represents the recognition of certain costs of hedging for example, basis adjustments, which have been excluded from the hedging relationship and deferred in other comprehensive income until the hedged transaction impacts the income statement.
Foreign currency translation reserve	(14)	(14)	(14)	The foreign currency translation reserve represents exchange differences arising from the translation of non-US dollar functional currency operations within the Group into US dollars.
Equity investments reserve	(21)	9	(8)	The equity investment reserve represents the revaluation of investments in shares recognised through other comprehensive income. Where a revalued financial asset is sold, the relevant portion of the reserve is transferred to retained earnings.
Non-controlling interest contribution reserve	1,437	1,441	1,441	The non-controlling interest contribution reserve represents the excess of consideration received over the book value of net assets attributable to equity instruments when acquired by non-controlling interests.
<b>Total reserves</b>	<u>(15)</u>	<u>13</u>	<u>12</u>	

Summarised financial information relating to each of the Group's subsidiaries with non-controlling interests (NCI) that are significant to the Group is shown below:

US\$M	<u>2024</u>			<u>2023</u>		
	Minera Escondida Limitada	Other individually immaterial subsidiaries	Total	Minera Escondida Limitada	Other individually immaterial subsidiaries	Total
<b>Group share (per cent)</b>	57.5			57.5		
Current assets	3,683			3,144		
Non-current assets	12,639			12,160		
Current liabilities	(2,484)			(1,598)		
Non-current liabilities	(4,989)			(5,413)		
Net assets	8,849			8,293		
<b>Net assets attributable to NCI</b>	3,761	548	4,309	3,525	509	4,034
Revenue	10,013			8,847		
Profit after taxation	2,894			2,365		
Other comprehensive income	13			(8)		
Total comprehensive income	2,907			2,357		
<b>Profit after taxation attributable to NCI</b>	1,230	474	1,704	1,005	398	1,403
<b>Other comprehensive income attributable to NCI</b>	6	(2)	4	(3)	-	(3)
<b>Net operating cash flow</b>	4,180			3,168		
<b>Net investing cash flow</b>	(1,806)			(1,351)		
<b>Net financing cash flow</b>	(2,415)			(1,620)		
<b>Dividends paid to NCI</b>	993	431	1,424	712	463	1,175

While the Group controls Minera Escondida Limitada, the non-controlling interests hold certain protective rights that restrict the Group's ability to sell assets held by Minera Escondida Limitada, or use the assets in other subsidiaries and operations owned by the Group. Minera Escondida Limitada is also restricted from paying dividends without the approval of the non-controlling interests.

## 19 Dividends

	Year ended 30 June 2024		Year ended 30 June 2023		Year ended 30 June 2022	
	Per share	Total	Per share	Total	Per share	Total
	US cents	US\$M	US cents	US\$M	US cents	US\$M
<b>Dividends paid during the period</b>						
Prior year final dividend	80	4,065	175	8,858	200	10,119
Interim dividend	72	3,647	90	4,562	150	7,601
	<b>152</b>	<b>7,712</b>	<b>265</b>	<b>13,420</b>	<b>350</b>	<b>17,720</b>

Dividends paid during the period differs from the amount of dividends paid in the Consolidated Cash Flow Statement as a result of foreign exchange gains and losses relating to the timing of equity distributions between the record date and the payment date. Additional derivative settlements of US\$44 million were made as part of the funding of the dividend paid during the period and is disclosed in Proceeds/(settlements) of cash management related instruments in the Consolidated Cash Flow Statement.

Each American Depositary Share (ADS) represents two ordinary shares of BHP Group Limited. Dividends determined on each ADS represent twice the dividend determined on each BHP Group Limited ordinary share.

Dividends are determined after period-end and announced with the results for the period. Interim dividends are determined in February and paid in March. Final dividends are determined in August and paid in September or October. Dividends determined are not recorded as a liability at the end of the period to which they relate. Subsequent to year-end, on 27 August 2024, BHP Group Limited determined a final dividend of 74 US cents per share (US\$3,752 million), which will be paid on 3 October 2024 (30 June 2023: final dividend of 80 US cents per share – US\$4,052 million; 30 June 2022: final dividend of 175 US cents per share – US\$8,857 million).

BHP Group Limited dividends for all periods presented are, or will be, fully franked based on a tax rate of 30 per cent.

	2024	2023	2022
	US\$M	US\$M	US\$M
Franking credits as at 30 June	9,165	7,953	7,007
Franking credits arising on the future payment/(refund) of taxes relating to the period	83	(261)	2,043
<b>Total franking credits available<sup>1</sup></b>	<b>9,248</b>	<b>7,692</b>	<b>9,050</b>

<sup>1</sup> The payment of the final 2024 dividend determined after 30 June 2024 will reduce the franking account balance by US\$1,608 million.

## 20 Provisions for dividends and other liabilities

The disclosure below excludes closure and rehabilitation provisions (refer to note 15 'Closure and rehabilitation provisions'), employee benefits, restructuring and post-retirement employee benefits provisions (refer to note 27 'Employee benefits, restructuring and post-retirement employee benefits provisions') and provision related to the Samarco dam failure (refer to note 4 'Significant events – Samarco dam failure').

	2024	2023
	US\$M	US\$M
At the beginning of the financial year	769	674
Acquisition of subsidiaries and operations <sup>1</sup>	–	61
Dividends determined	7,712	13,420
Charge/(credit) for the year:		
Underlying	180	156
Discounting	2	2
Exchange variations	(42)	(161)
Released during the year	(120)	(62)
Utilisation	(92)	(35)
Dividends paid	(7,675)	(13,268)
Transfers and other movements	(24)	(18)
<b>At the end of the financial year</b>	<b>710</b>	<b>769</b>
Comprising:		
Current	220	384
Non-current	490	385

<sup>1</sup> Relates to the acquisition of OZL on 2 May 2023. Refer to note 29 'Business combinations' for more information.



## Financial management

### 21 Net debt

The Group seeks to maintain a strong balance sheet and deploys its capital with reference to the Capital Allocation Framework.

The Group monitors capital using the net debt balance and the gearing ratio, being the ratio of net debt to net debt plus net assets.

The net debt definition includes the fair value of derivative financial instruments used to hedge cash and borrowings which reflects the Group's risk management strategy of reducing the volatility of net debt caused by fluctuations in foreign exchange and interest rates.

Under IFRS 16/AASB16 'Leases', certain vessel lease contracts are required to be remeasured at each reporting date to the prevailing freight index. While these liabilities are included in the Group interest bearing liabilities, they are excluded from the net debt calculation as they do not align with how the Group assesses net debt for decision making in relation to the Capital Allocation Framework. In addition, the freight index has historically been volatile which creates significant short-term fluctuation in these liabilities.

US\$M	2024		2023	
	Current	Non-current	Current	Non-current
<b>Interest bearing liabilities</b>				
Bank loans	540	2,070	5,310	2,192
Notes and debentures	848	14,084	1,337	10,482
Lease liabilities	686	2,430	521	2,498
Bank overdraft and short-term borrowings	3	–	5	–
Other	7	50	–	–
<b>Total interest bearing liabilities</b>	<b>2,084</b>	<b>18,634</b>	<b>7,173</b>	<b>15,172</b>
<b>Less: Lease liability associated with index-linked freight contracts</b>	<b>267</b>	<b>244</b>	<b>114</b>	<b>173</b>
<b>Less: Cash and cash equivalents</b>				
Cash	8,150	–	7,206	–
Short-term deposits	4,351	–	5,222	–
<b>Less: Total cash and cash equivalents</b>	<b>12,501</b>	<b>–</b>	<b>12,428</b>	<b>–</b>
<b>Less: Derivatives included in net debt</b>				
Net debt management related instruments <sup>1</sup>	(171)	(1,224)	(113)	(1,459)
Net cash management related instruments <sup>2</sup>	(19)	–	36	–
<b>Less: Total derivatives included in net debt</b>	<b>(190)</b>	<b>(1,224)</b>	<b>(77)</b>	<b>(1,459)</b>
<b>Net debt</b>		<b>9,120</b>		<b>11,166</b>
<b>Net assets</b>		<b>49,120</b>		<b>48,530</b>
<b>Gearing</b>		<b>15.7%</b>		<b>18.7%</b>

<sup>1</sup> Represents the net cross currency and interest rate swaps designated as effective hedging instruments included within current and non-current other financial assets and liabilities.

<sup>2</sup> Represents the net forward exchange contracts included within current and non-current other financial assets and liabilities.

Cash and short-term deposits are disclosed in the cash flow statement net of bank overdrafts and interest bearing liabilities at call.

	2024	2023	2022
	US\$M	US\$M	US\$M
Total cash and cash equivalents	12,501	12,428	17,236
Bank overdrafts and short-term borrowings	(3)	(5)	–
<b>Total cash and cash equivalents, net of overdrafts</b>	<b>12,498</b>	<b>12,423</b>	<b>17,236</b>

Cash and cash equivalents includes US\$112 million (2023: US\$95 million) restricted by legal or contractual arrangements.

### Recognition and measurement

Cash and short-term deposits in the balance sheet comprise cash at bank and on hand and highly liquid cash deposits with short-term maturities that are readily convertible to known amounts of cash with insignificant risk of change in value. The Group considers that the carrying value of cash and cash equivalents approximate fair value due to their short-term to maturity. Refer to note 22 'Leases' and note 24 'Financial risk management' for the recognition and measurement principles for lease liabilities and other financial liabilities.

Interest bearing liabilities and cash and cash equivalents include balances denominated in the following currencies:

	Interest bearing liabilities		Cash and cash equivalents	
	2024	2023	2024	2023
	US\$M	US\$M	US\$M	US\$M
USD	15,203	16,289	4,445	5,925
EUR	2,440	3,050	5	544
GBP	1,613	1,587	711	674
AUD	1,265	1,233	3,840	1,797
CAD	5	7	3,259	3,362
Other	192	179	241	126
<b>Total</b>	<b>20,718</b>	<b>22,345</b>	<b>12,501</b>	<b>12,428</b>

The Group enters into derivative transactions to convert the majority of its exposures above into US dollars. Further information on the Group's risk management activities relating to these balances is provided in note 24 'Financial risk management'.

### Liquidity risk

The Group's liquidity risk arises from the possibility that it may not be able to settle or meet its obligations as they fall due and is managed as part of the portfolio risk management strategy. Operational, capital and regulatory requirements are considered in the management of liquidity risk, in conjunction with short-term and long-term forecast information.

Recognising the cyclical volatility of operating cash flows, the Group has defined minimum target cash and liquidity buffers to be maintained to mitigate liquidity risk and support operations through the cycle.

The Group's strong credit profile, diversified funding sources, its minimum cash buffer and its committed credit facilities ensure that sufficient liquid funds are maintained to meet its daily cash requirements.

The Group's Moody's credit rating has remained at A1/P-1 outlook stable (long-term/short-term). The Group's S&P Global's rating has remained at A-/A-1 outlook stable (long-term/short-term).

There were no defaults on the Group's liabilities during the period.

### Counterparty risk

The Group is exposed to credit risk from its financing activities, including short-term cash investments such as deposits with banks and derivative contracts. This risk is managed by Group Treasury in line with the counterparty risk framework, which aims to minimise the exposure to a counterparty and mitigate the risk of financial loss through counterparty failure.

Exposure to counterparties is monitored at a Group level across all products and includes exposure with derivatives and cash investments.

Investments and derivatives are only transacted with approved counterparties who have been assigned specific limits based on a quantitative credit risk model. These limits are updated at least bi-annually. Additionally, derivatives are subject to tenor limits and investments are subject to concentration limits by rating.

Derivative fair values are inclusive of valuation adjustments that take into account both the counterparty and the Group's risk of default.

### Standby arrangements and unused credit facilities

The Group's committed revolving credit facility operates as a back-stop to the Group's uncommitted commercial paper program. The combined amount drawn under the facility or as commercial paper will not exceed US\$5.5 billion. As at 30 June 2024, US\$ nil commercial paper was drawn (2023: US\$ nil). The facility is due to mature on 10 October 2026. A commitment fee is payable on the undrawn balance and interest is payable on any drawn balance comprising a reference rate plus a margin. The agreed margins are typical for a credit facility extended to a company with the Group's credit rating.

*Maturity profile of financial liabilities*

The maturity profile of the Group's financial liabilities based on the undiscounted contractual amounts, taking into account the derivatives related to debt, is as follows:

2024 US\$M	Bank loans, debentures and other loans	Expected future interest payments	Derivatives related to debentures	Other financial liabilities	Obligations under lease liabilities	Trade and other payables <sup>1</sup>	Total
<b>Due for payment:</b>							
In one year or less or on demand	1,402	884	485	333	836	6,618	10,558
In more than one year but not more than two years	1,362	827	171	67	591	15	3,033
In more than two years but not more than five years	4,960	1,923	377	233	1,012	27	8,532
In more than five years	10,999	4,784	1,131	163	1,761	3	18,841
<b>Total</b>	<b>18,723</b>	<b>8,418</b>	<b>2,164</b>	<b>796</b>	<b>4,200</b>	<b>6,663</b>	<b>40,964</b>
<b>Carrying amount</b>	<b>17,602</b>	<b>–</b>	<b>1,513</b>	<b>758</b>	<b>3,116</b>	<b>6,663</b>	<b>29,652</b>
2023 US\$M	Bank loans, debentures and other loans	Expected future interest payments	Derivatives related to debentures	Other financial liabilities	Obligations under lease liabilities	Trade and other payables <sup>1</sup>	Total
<b>Due for payment:</b>							
In one year or less or on demand	6,659	757	536	257	658	6,175	15,042
In more than one year but not more than two years	1,399	595	388	126	538	4	3,050
In more than two years but not more than five years	4,058	1,410	399	267	1,031	–	7,165
In more than five years	8,093	3,693	1,020	211	1,846	–	14,863
<b>Total</b>	<b>20,209</b>	<b>6,455</b>	<b>2,343</b>	<b>861</b>	<b>4,073</b>	<b>6,179</b>	<b>40,120</b>
<b>Carrying amount</b>	<b>19,326</b>	<b>–</b>	<b>1,755</b>	<b>804</b>	<b>3,019</b>	<b>6,179</b>	<b>31,083</b>

<sup>1</sup> Excludes input taxes of US\$101 million (2023: US\$121 million) included in other payables.

## 22 Leases

Movements in the Group's lease liabilities during the year are as follows:

	<u>2024</u>	<u>2023</u>
	US\$M	US\$M
At the beginning of the financial year	3,019	2,576
Additions	593	542
Acquisition of subsidiaries and operations <sup>1</sup>	–	423
Remeasurements of index-linked freight contracts	230	53
Lease payments	(837)	(706)
Foreign exchange movement	(16)	12
Amortisation of discounting	181	130
Divestment of subsidiaries and operations <sup>2</sup>	(60)	–
Transfers and other movements	6	(11)
<b>At the end of the financial year</b>	<b>3,116</b>	<b>3,019</b>
Comprising:		
Current liabilities	686	521
Non-current liabilities	2,430	2,498

<sup>1</sup> Relates to the acquisition of OZL on 2 May 2023. Refer to note 29 'Business combinations' for more information.

<sup>2</sup> Relates to the divestment of the Blackwater and Daunia mines completed on 2 April 2024. Refer to note 3 'Exceptional items' for more information.

A significant proportion by value of the Group's lease contracts relate to plant facilities, office buildings and vessels. Lease terms for plant facilities and office buildings typically run for over 10 years and vessels from four to 10 years. Other leases include port facilities, various equipment and vehicles. The lease contracts contain a wide range of different terms and conditions including extension and termination options and variable lease payments.

The Group's lease obligations are included in the Group's Interest bearing liabilities and, with the exception of vessel lease contracts that are priced with reference to a freight index, form part of the Group's net debt.

The maturity profile of lease liabilities based on the undiscounted contractual amounts is as follows:

Lease liability	<u>2024</u>	<u>2023</u>
	US\$M	US\$M
<b>Due for payment:</b>		
In one year or less or on demand	836	658
In more than one year but not more than two years	591	538
In more than two years but not more than five years	1,012	1,031
In more than five years <sup>1</sup>	1,761	1,846
<b>Total</b>	<b>4,200</b>	<b>4,073</b>
<b>Carrying amount</b>	<b>3,116</b>	<b>3,019</b>

<sup>1</sup> Includes US\$738 million (2023: US\$808 million) due for payment in more than ten years.

At 30 June 2024, commitments for leases not yet commenced based on undiscounted contractual amounts were US\$1,170 million (2023: US\$1,271 million).

Movements in the Group's right-of-use assets during the year are as follows:

	2024			2023		
	Land and buildings	Plant and equipment	Total	Land and buildings	Plant and equipment	Total
	US\$M	US\$M	US\$M	US\$M	US\$M	US\$M
<b>Net book value</b>						
At the beginning of the financial year	573	2,236	2,809	452	1,909	2,361
<b>Additions</b>	<b>26</b>	<b>567</b>	<b>593</b>	192	350	542
Acquisition of subsidiaries and operations	–	–	–	–	423	423
Remeasurements of index-linked freight contracts	–	230	230	–	53	53
Depreciation expensed during the period	(79)	(638)	(717)	(71)	(462)	(533)
Impairments for the year	–	(140)	(140)	–	–	–
Divestment of subsidiaries and operations <sup>1</sup>	(30)	(40)	(70)	–	–	–
Transfers and other movements	–	3	3	–	(37)	(37)
<b>At the end of the financial year</b>	<b>490</b>	<b>2,218</b>	<b>2,708</b>	573	2,236	2,809
– Cost	742	4,479	5,221	758	4,088	4,846
– Accumulated depreciation and impairments	(252)	(2,261)	(2,513)	(185)	(1,852)	(2,037)

<sup>1</sup> Relates to the divestment of the Blackwater and Daunia mines completed on 2 April 2024. Refer to note 3 'Exceptional items' for more information.

Right-of-use assets are included within the underlying asset classes in Property, plant and equipment. Refer to note 11 'Property, plant and equipment'.

Amounts recorded in the income statement and the cash flow statement for the year were:

	2024	2023	2022	Included within
	US\$M	US\$M	US\$M	
<b>Income statement</b>				
Depreciation of right-of-use assets	717	533	964	Profit from operations
Short-term, low-value and variable lease costs <sup>1</sup>	916	795	847	Profit from operations
Interest on lease liabilities	181	130	119	Financial expenses
<b>Cash flow statement</b>				
Principal lease payments	656	576	1,130	Cash flows from financing activities
Lease interest payments	181	130	119	Cash flows from operating activities

<sup>1</sup> Relates to US\$792 million of variable lease costs (2023: US\$714 million; 2022: US\$585 million), US\$96 million of short-term lease costs (2023: US\$47 million; 2022: US\$222 million) and US\$28 million of low-value lease costs (2023: US\$34 million; 2022: US\$40 million). Variable lease costs include contracts for hire of mining service equipment, drill rigs and transportation services. These contracts contain variable lease payments based on usage and asset performance.

#### Recognition and measurement

All leases with the exception of short-term (under 12 months) and low-value leases are recognised on the balance sheet, as a right-of-use asset and a corresponding interest bearing liability. Lease liabilities are initially measured at the present value of the future lease payments from the lease commencement date and are subsequently adjusted to reflect the interest on lease liabilities, lease payments and any remeasurements due to, for example, lease modifications or a change to future lease payments linked to an index or rate. Lease payments are discounted using the interest rate implicit in the lease or, where the rate is not readily determinable, the interest payments are discounted at the Group's weighted average incremental borrowing rate, adjusted to reflect factors specific to the lease, including where relevant the currency, tenor and location of the lease.

In addition to containing a lease, the Group's contractual arrangements may include non-lease components. For example, certain mining services arrangements involve the provision of additional services, including maintenance, drilling activities and the supply of personnel. The Group has elected to separate these non-lease components from the lease components in measuring lease liabilities. Non-lease components are accounted for in accordance with the accounting policies applied to each underlying good or service received.

Low-value and short-term leases are expensed to the income statement. Variable lease payments not dependent on an index or rate are excluded from lease liabilities, and expensed to the income statement.

Right-of-use assets are measured at cost, less any accumulated depreciation and impairment losses, and adjusted for any remeasurement of lease liabilities. The cost will initially correspond to the lease liability, adjusted for initial direct costs, lease payments made prior to lease commencement, capitalised provisions for closure and rehabilitation and any lease incentives received.

The lease asset and liability associated with all index-linked freight contracts, including continuous voyage charters (CVCs), are measured at each reporting date based on the prevailing freight index (generally the Baltic C5 index).

Where the Group is the operator of an unincorporated joint operation and all investors are parties to a lease, the Group recognises its proportionate share of the lease liability and associated right-of-use asset. In the event the Group is the sole signatory to a lease, and therefore has the sole legal obligation to make lease payments, the lease liability is recognised in full. Where the associated right-of-use asset is sub-leased (under a finance sub-lease) to a joint operation, for instance where it is dedicated to a single operation and the joint operation has the right to direct the use of the asset, the Group (as lessor) recognises its proportionate share of the right-of-use asset and a net investment in the lease, representing amounts to be recovered from the other parties to the joint operation. If the Group is not party to the head lease contract but sub-leases the associated right-of-use asset (as lessee), it recognises its proportionate share of the right-of-use asset and a lease liability which is payable to the operator.

### Key judgements and estimates

*Judgements:* Certain contractual arrangements not in the form of a lease require the Group to apply significant judgement in evaluating whether the Group controls the right to direct the use of assets and therefore whether the contract contains a lease. Management considers all facts and circumstances in determining whether the Group or the supplier has the rights to direct how, and for what purpose, the underlying assets are used in certain mining contracts and other arrangements, including outsourcing and shipping arrangements. Judgement is used to assess which decision-making rights mostly affect the benefits of use of the assets for each arrangement.

Where a contract includes the provision of non-lease services, judgement is required to identify the lease and non-lease components.

*Estimates:* Where the Group cannot readily determine the interest rate implicit in the lease, estimation is involved in the determination of the weighted average incremental borrowing rate to measure lease liabilities. The incremental borrowing rate reflects the rates of interest a lessee would have to pay to borrow over a similar term, with similar security, the funds necessary to obtain an asset of similar value to the right-of-use asset in a similar economic environment. Under the Group's portfolio approach to debt management, the Group does not specifically borrow for asset purchases. Therefore, the incremental borrowing rate is estimated referencing the Group's corporate borrowing portfolio and other similar rated entities, adjusted to reflect the terms and conditions of the lease (including the impact of currency, credit rating of subsidiary entering into the lease and the term of the lease), at the inception of the lease arrangement or the time of lease modification.

The Group estimates stand-alone prices, where such prices are not readily observable, in order to allocate the contractual payments between lease and non-lease components.

## 23 Net finance costs

	<u>2024</u>	<u>2023</u>	<u>2022</u>
	US\$M	US\$M	US\$M
<b>Financial expenses</b>			
<i>Interest expense using the effective interest rate method:</i>			
Interest on bank loans, overdrafts and all other borrowings	1,467	997	491
Interest capitalised at 6.82% (2023: 5.71%; 2022: 2.90%) <sup>1</sup>	(530)	(271)	(113)
Interest on lease liabilities	181	130	119
Discounting on provisions and other liabilities	1,064	1,293	645
<i>Other gains and losses:</i>			
Fair value change on hedged loans	(214)	(803)	(1,286)
Fair value change on hedging derivatives	188	691	1,277
Exchange variations on net debt	27	9	(99)
Other	15	14	16
<b>Total financial expenses</b>	<b>2,198</b>	<b>2,060</b>	<b>1,050</b>
<b>Financial income</b>			
Interest income	(709)	(529)	(81)
<b>Net finance costs</b>	<b>1,489</b>	<b>1,531</b>	<b>969</b>

<sup>1</sup> Interest has been capitalised at the rate of interest applicable to the specific borrowings financing the assets under construction or, where financed through general borrowings, at a capitalisation rate representing the average interest rate on such borrowings. Tax relief for capitalised interest is approximately US\$159 million (2023: US\$81 million; 2022: US\$34 million).

### Recognition and measurement

Interest income is accrued using the effective interest rate method. Finance costs are expensed as incurred, except where they relate to the financing of construction or development of qualifying assets.

## 24 Financial risk management

### 24.1 Financial risks

#### Financial and capital risk management strategy

The financial risks arising from the Group's operations comprise market, liquidity and credit risk. These risks arise in the normal course of business and the Group manages its exposure to them in accordance with the Group's portfolio risk management strategy. The objective of the strategy is to support the delivery of the Group's financial targets, while protecting its future financial security and flexibility by taking advantage of the natural diversification provided by the scale, diversity and flexibility of the Group's operations and activities.

As part of the risk management strategy, the Group monitors target gearing levels and credit rating metrics under a range of different stress test scenarios incorporating operational and macroeconomic factors.

#### Market risk management

The Group's activities expose it to market risks associated with movements in interest rates, foreign currencies and commodity prices. Under the strategy outlined above, the Group seeks to achieve financing costs, currency impacts, input costs and commodity prices on a floating or index basis.

In executing the strategy, financial instruments are potentially employed in three distinct but related activities. The following table summarises these activities and the key risk management processes:

Activity	Key risk management processes
<b>1 Risk mitigation</b>	
On an exception basis, hedging for the purposes of mitigating risk related to specific and significant expenditure on investments or capital projects will be executed if necessary to support the Group's strategic objectives.	Execution of transactions within approved mandates.
<b>2 Economic hedging of commodity sales, operating costs, short-term cash deposits, other monetary items and debt instruments</b>	
Where Group commodity production is sold to customers on pricing terms that deviate from the relevant index target and where a relevant derivatives market exists, financial instruments may be executed as an economic hedge to align the revenue price exposure with the index target and US dollars.	Measuring and reporting the exposure in customer commodity contracts and issued debt instruments.
Where debt is issued in a currency other than the US dollar and/or at a fixed interest rate, fair value and cash flow hedges may be executed to align the debt exposure with the Group's functional currency of US dollars and/or to swap to a floating interest rate.	Executing hedging derivatives to align the total group exposure to the index target.
Where short-term cash deposits and other monetary items are denominated in a currency other than US dollars, derivative financial instruments may be executed to align the foreign exchange exposure to the Group's functional currency of US dollars.	Execution of transactions within approved mandates.
<b>3 Strategic financial transactions</b>	
Opportunistic transactions may be executed with financial instruments to capture value from perceived market over/under valuations.	Execution of transactions within approved mandates.

Primary responsibility for the identification and control of financial risks, including authorising and monitoring the use of financial instruments for the above activities and stipulating policy thereon, rests with the Financial Risk Management Committee under authority delegated by the Chief Executive Officer.

#### Interest rate risk

The Group is exposed to interest rate risk on its outstanding borrowings and short-term cash deposits from the possibility that changes in interest rates will affect future cash flows or the fair value of fixed interest rate financial instruments. Interest rate risk is managed as part of the portfolio risk management strategy.

The majority of the Group's debt is issued at fixed interest rates. The Group has entered into interest rate swaps and cross currency interest rate swaps to convert most of its fixed interest rate exposure to floating US dollar interest rate exposure. As at 30 June 2024, 97 per cent of the Group's borrowings were exposed to floating interest rates inclusive of the effect of swaps (2023: 98 per cent).

The fair value of interest rate swaps and cross currency interest rate swaps in hedge relationships used to hedge both interest rate and foreign currency risks are shown in the valuation hierarchy in section 24.4 'Derivatives and hedge accounting'.

Based on the net debt position as at 30 June 2024, taking into account interest rate swaps and cross currency interest rate swaps, it is estimated that a one percentage point increase in the Secured Overnight Financing Rate (SOFR) interest rate will decrease the Group's equity and profit after taxation by US\$47 million (2023: decrease of US\$58 million). This assumes the change in interest rates is effective from the beginning of the financial year and the fixed/floating mix and balances are constant over the year.

### Currency risk

The US dollar is the predominant functional currency within the Group and as a result, currency exposures arise from transactions and balances in currencies other than the US dollar. The Group's potential currency exposures comprise:

- translational exposure in respect of non-functional currency monetary items
- transactional exposure in respect of non-functional currency expenditure and revenues

The Group's foreign currency risk is managed as part of the portfolio risk management strategy.

#### *Translational exposure in respect of non-functional currency monetary items*

Monetary items, including financial assets and liabilities, denominated in currencies other than the functional currency of an operation are restated at the end of each reporting period to US dollar equivalents and the associated gain or loss is taken to the income statement. The exception is foreign exchange gains or losses on foreign currency denominated provisions for closure and rehabilitation at operating sites, which are capitalised in property, plant and equipment.

The Group has entered into cross currency interest rate swaps and foreign exchange forwards to convert its significant foreign currency exposures in respect of monetary items into US dollars. Fluctuations in foreign exchange rates are therefore not expected to have a significant impact on equity and profit after tax.

The following table shows the carrying values of financial assets and liabilities at the end of the reporting period denominated in currencies other than the US dollar that are exposed to foreign currency risk:

<b>Net financial (liabilities)/assets - by currency of denomination</b>	<b>2024</b>	<b>2023</b>
	<b>US\$M</b>	<b>US\$M</b>
AUD	<b>(3,850)</b>	<b>(4,168)</b>
CAD	<b>(543)</b>	<b>(312)</b>
CLP	<b>(150)</b>	<b>(74)</b>
GBP	<b>323</b>	<b>353</b>
EUR	<b>239</b>	<b>217</b>
Other	<b>43</b>	<b>355</b>
<b>Total</b>	<b><u>(3,938)</u></b>	<b><u>(3,629)</u></b>

The principal non-functional currencies to which the Group is exposed are the Australian dollar, the Canadian dollar, the Chilean peso, the Pound sterling and the Euro. Based on the Group's net financial assets and liabilities as at 30 June 2024, a weakening of the US dollar against these currencies (one cent strengthening in Australian dollar, one cent strengthening in Canadian dollar, 10 pesos strengthening in Chilean peso, one penny strengthening in Pound sterling and one cent strengthening in Euro), with all other variables held constant, would decrease the Group's equity and profit after taxation by US\$17 million (2023: decrease of US\$15 million).

#### *Transactional exposure in respect of non-functional currency expenditure and revenues*

Certain operating and capital expenditure is incurred in currencies other than an operation's functional currency. To a lesser extent, certain sales revenue is earned in currencies other than the functional currency of operations and certain exchange control restrictions may require that funds be maintained in currencies other than the functional currency of the operation. These currency risks are managed as part of the portfolio risk management strategy. The Group may enter into forward exchange contracts when required under this strategy.

### Commodity price risk

The risk associated with commodity prices is managed as part of the portfolio risk management strategy. Substantially all of the Group's commodity production is sold on market-based index pricing terms, with derivatives used from time to time to achieve a specific outcome.

Financial instruments with commodity price risk comprise forward commodity and other derivative contracts with net liabilities at fair value of US\$42 million (2023: net liabilities of US\$20 million).

#### *Provisionally priced commodity sales and purchases contracts*

Provisionally priced sales or purchases volumes are those for which price finalisation, referenced to the relevant index, is outstanding at the reporting date. Provisional pricing mechanisms within these sales and purchases arrangements have the character of a commodity derivative. Trade receivables or payables under these contracts are carried at fair value through profit or loss using Level 2 valuation inputs based on forecast selling prices in the quotation period. The Group's exposure at 30 June 2024 to the impact of movements in commodity prices upon provisionally invoiced sales and purchases volumes was predominately around copper.

The Group had 428 thousand tonnes of copper exposure as at 30 June 2024 (2023: 314 thousand tonnes) that was provisionally priced. The final price of these sales and purchases volumes will be determined during the first half of FY2025. A 10 per cent change in the price of copper realised on the provisionally priced sales, with all other factors held constant, would increase or decrease profit after taxation by US\$299 million (2023: US\$184 million).

The relationship between commodity prices and foreign currencies is complex and movements in foreign exchange rates can impact commodity prices.



## Liquidity risk

Refer to note 21 'Net debt' for details on the Group's liquidity risk.

## Credit risk

Credit risk is the risk that a counterparty will not meet its obligations under a financial instrument or customer contract, leading to a financial loss. The Group is exposed to credit risk from its operating activities (primarily from customer receivables) and from its financing activities, including deposits with banks and financial institutions, other short-term investments, interest rate and currency derivative contracts and other financial instruments.

Refer to note 8 'Trade and other receivables' and note 21 'Net debt' for details on the Group credit risk.

## 24.2 Recognition and measurement

All financial assets and liabilities, other than derivatives and trade receivables, are initially recognised at the fair value of consideration paid or received, net of transaction costs as appropriate. Financial assets are initially recognised on their trade date.

Financial assets are subsequently carried at fair value or amortised cost based on:

- the Group's purpose, or business model, for holding the financial asset
- whether the financial asset's contractual terms give rise to cash flows that are solely payments of principal and interest

The resulting Financial Statements classifications of financial assets can be summarised as follows:

<b>Contractual cash flows</b>	<b>Business model</b>	<b>Category</b>
Solely principal and interest	Hold in order to collect contractual cash flows	Amortised cost
Solely principal and interest	Hold in order to collect contractual cash flows and sell	Fair value through other comprehensive income
Solely principal and interest	Hold in order to sell	Fair value through profit or loss
Other	Any of those mentioned above	Fair value through profit or loss

Solely principal and interest refers to the Group receiving returns only for the time value of money and the credit risk of the counterparty for financial assets held. The main exceptions for the Group are provisionally priced receivables and derivatives which are measured at fair value through profit or loss under IFRS 9.

The Group has the intention of collecting payment directly from its customers in most cases, however the Group also participates in receivables financing programs in respect of selected customers. Receivables in these portfolios which are classified as 'hold in order to sell', are provisionally priced receivables and are therefore held at fair value through profit or loss prior to sale to the financial institution.

With the exception of derivative contracts and provisionally priced trade payables which are carried at fair value through profit or loss, the Group's financial liabilities are classified as subsequently measured at amortised cost.

The Group may in addition elect to designate certain financial assets or liabilities at fair value through profit or loss or to apply hedge accounting where they are not mandatorily held at fair value through profit or loss.

## Fair value measurement

The carrying amount of financial assets and liabilities measured at fair value is principally calculated based on inputs other than quoted prices that are observable for these financial assets or liabilities, either directly (i.e. as unquoted prices) or indirectly (i.e. derived from prices). Where no price information is available from a quoted market source, alternative market mechanisms or recent comparable transactions, fair value is estimated based on the Group's views on relevant future prices, net of valuation allowances to accommodate liquidity, modelling and other risks implicit in such estimates.

The inputs used in fair value calculations are determined by the relevant segment or function. The functions support the assets and operate under a defined set of accountabilities authorised by the Executive Leadership Team. Movements in the fair value of financial assets and liabilities may be recognised through the income statement or in other comprehensive income according to the designation of the underlying instrument.

For financial assets and liabilities carried at fair value, the Group uses the following to categorise the inputs to the valuation method used based on the lowest level input that is significant to the fair value measurement as a whole:

<b>IFRS 13 Fair value hierarchy</b>	<b>Level 1</b>	<b>Level 2</b>	<b>Level 3</b>
Valuation inputs	Based on quoted prices (unadjusted) in active markets for identical financial assets and liabilities.	Based on inputs other than quoted prices included within Level 1 that are observable for the financial asset or liability, either directly (i.e. as unquoted prices) or indirectly (i.e. derived from prices).	Based on inputs not observable in the market using appropriate valuation models, including discounted cash flow modelling.

## 24.3 Financial assets and liabilities

The financial assets and liabilities are presented by class in the table below at their carrying amounts.

	IFRS 13 Fair value hierarchy Level <sup>1</sup>	IFRS 9 Classification	2024 US\$M	2023 US\$M
Current cross currency and interest rate swaps <sup>2</sup>	2	Fair value through profit or loss	5	34
Current other derivative contracts <sup>3</sup>	2,3	Fair value through profit or loss	118	407
Current other financial assets <sup>4</sup>		Amortised cost	234	–
Current other investments <sup>5</sup>	1,2	Fair value through profit or loss	24	29
Non-current cross currency and interest rate swaps <sup>2</sup>	2	Fair value through profit or loss	113	149
Non-current other derivative contracts <sup>3</sup>	2,3	Fair value through profit or loss	103	228
Non-current other financial assets <sup>6</sup>	3	Fair value through profit or loss	195	246
Non-current other financial assets <sup>4,7</sup>		Amortised cost	398	–
Non-current investment in shares	1,3	Fair value through other comprehensive income	201	224
Non-current other investments <sup>5</sup>	1,2	Fair value through profit or loss	219	268
<b>Total other financial assets</b>			<b>1,610</b>	<b>1,585</b>
Cash and cash equivalents		Amortised cost	12,501	12,428
Trade and other receivables <sup>8</sup>		Amortised cost	1,597	1,506
Provisionally priced trade receivables	2	Fair value through profit or loss	3,250	2,705
<b>Total financial assets</b>			<b>18,958</b>	<b>18,224</b>
Non-financial assets			83,404	83,072
<b>Total assets</b>			<b>102,362</b>	<b>101,296</b>
Current cross currency and interest rate swaps <sup>2</sup>	2	Fair value through profit or loss	176	147
Current other derivative contracts	2	Fair value through profit or loss	241	176
Current other financial liabilities <sup>9</sup>		Amortised cost	95	79
Non-current cross currency and interest rate swaps <sup>2</sup>	2	Fair value through profit or loss	1,337	1,608
Non-current other derivative contracts <sup>3</sup>	2,3	Fair value through profit or loss	54	82
Non-current other financial liabilities <sup>9</sup>		Amortised cost	368	467
<b>Total other financial liabilities</b>			<b>2,271</b>	<b>2,559</b>
Trade and other payables <sup>10</sup>		Amortised cost	6,049	5,338
Provisionally priced trade payables	2	Fair value through profit or loss	614	841
Bank overdrafts and short-term borrowings <sup>11</sup>		Amortised cost	3	5
Bank loans <sup>11</sup>		Amortised cost	2,610	7,502
Notes and debentures <sup>11</sup>		Amortised cost	14,932	11,819
Lease liabilities <sup>12</sup>			3,116	3,019
Other <sup>11</sup>		Amortised cost	57	–
<b>Total financial liabilities</b>			<b>29,652</b>	<b>31,083</b>
Non-financial liabilities			23,590	21,683
<b>Total liabilities</b>			<b>53,242</b>	<b>52,766</b>

<sup>1</sup> All of the Group's financial assets and financial liabilities recognised at fair value were valued using market observable inputs categorised as Level 2 unless specified otherwise in the following footnotes.

<sup>2</sup> Cross currency and interest rate swaps are valued using market data including interest rate curves and foreign exchange rates. A discounted cash flow approach is used to derive the fair value of cross currency and interest rate swaps at the reporting date.

<sup>3</sup> Includes net other derivative assets of US\$92 million related to power purchase contract agreements that are categorised as Level 3 (2023: US\$46 million).

<sup>4</sup> Includes deferred consideration of US\$495 million in relation to the divestment of the Blackwater and Daunia mines.

<sup>5</sup> Includes investments held by BHP Foundation which are restricted and not available for general use by the Group of US\$243 million (2023: US\$290 million) of which other investments (mainly US Treasury Notes) of US\$134 million categorised as Level 1 (2023: US\$138 million).

<sup>6</sup> Includes receivables contingent on future realised coal price of US\$195 million (2023: US\$246 million receivables contingent on outcome of future events relating to mining and regulatory approvals).

<sup>7</sup> Includes Senior notes of US\$137 million relating to Samarco with a maturity date of 30 June 2031 (refer to note 4 'Significant events – Samarco dam failure' for further information).

<sup>8</sup> Excludes input taxes of US\$492 million (2023: US\$531 million) included in other receivables.

<sup>9</sup> Includes the discounted settlement liability in relation to the cancellation of power contracts at the Group's Escondida operations.

<sup>10</sup> Excludes input taxes of US\$101 million (2023: US\$121 million) included in other payables.

<sup>11</sup> All interest bearing liabilities, excluding lease liabilities, are unsecured.

<sup>12</sup> Lease liabilities are measured in accordance with IFRS 16/AASB 16 'Leases'.

The carrying amounts in the table above generally approximate to fair value. In the case of US\$532 million (2023: US\$534 million) of fixed rate debt not swapped to floating rate, the fair value at 30 June 2024 was US\$538 million (2023: US\$538 million). The fair value is determined using a method that can be categorised as Level 2 and uses inputs based on benchmark interest rates, alternative market mechanisms or recent comparable transactions.

For financial instruments that are carried at fair value on a recurring basis, the Group determines whether transfers have occurred between levels in the fair value hierarchy by reassessing categorisation at the end of each reporting period. There were no transfers between categories during the period.

#### **Offsetting financial assets and liabilities**

The Group enters into money market deposits and derivative transactions under International Swaps and Derivatives Association master netting agreements that do not meet the offsetting criteria in IAS 32/AASB 132 'Financial Instruments: Presentation', but allow for the related amounts to be set-off in certain circumstances. The amounts set out as cross currency and interest rate swaps in the table above represent the derivative financial assets and liabilities of the Group that may be subject to the above arrangements and are presented on a gross basis.

#### **24.4 Derivatives and hedge accounting**

The Group uses derivatives to hedge its exposure to certain market risks and may elect to apply hedge accounting.

##### **Hedge accounting**

Derivatives are included within financial assets or liabilities at fair value through profit or loss unless they are designated as effective hedging instruments.

Where hedge accounting is applied, at the start of the transaction, the Group documents the type of hedge, the relationship between the hedging instrument and hedged items and its risk management objective and strategy for undertaking various hedge transactions. The documentation also demonstrates that the hedge is expected to be effective.

The Group applies the following types of hedge accounting to its derivatives hedging the interest rate and currency risks of its notes and debentures:

- Fair value hedges – the fair value gain or loss on interest rate and cross currency swaps relating to interest rate risk, together with the change in the fair value of the hedged fixed rate borrowings attributable to interest rate risk are recognised immediately in the income statement. If the hedge no longer meets the criteria for hedge accounting, the fair value adjustment on the note or debenture is amortised to the income statement over the period to maturity using a recalculated effective interest rate.
- Cash flow hedges – changes in the fair value of cross currency interest rate swaps which hedge foreign currency cash flows on the notes and debentures are recognised directly in other comprehensive income and accumulated in the cash flow hedging reserve. To the extent a hedge is ineffective, changes in fair value are recognised immediately in the income statement.

When a hedging instrument expires, or is sold, terminated or exercised, or when a hedge no longer meets the criteria for hedge accounting, any cumulative gain or loss existing in equity at that time remains in equity and is amortised to the income statement over the period to the hedged item's maturity.

When hedged, the Group hedges the full notional value of notes or debentures. However, certain components of the fair value of derivatives are not permitted under IFRS 9 to be included in the hedge accounting above. Certain costs of hedging are permitted to be recognised in other comprehensive income. Any change in the fair value of a derivative that does not qualify for hedge accounting, or is ineffective in hedging the designated risk due to contractual differences between the hedged item and hedging instrument, is recognised immediately in the income statement.

The table below shows the carrying amounts of the Group's notes and debentures by currency and the derivatives which hedge them:

- The carrying amount of the notes and debentures includes foreign exchange remeasurement to period-end rates and fair value adjustments when included in a fair value hedge.
- The breakdown of the hedging derivatives includes remeasurement of foreign currency notional values at period-end rates, fair value movements due to interest rate risk, foreign currency cash flows designated into cash flow hedges, costs of hedging recognised in other comprehensive income, ineffectiveness recognised in the income statement and accruals or prepayments.
- The hedged value of notes and debentures includes their carrying amounts adjusted for the offsetting derivative fair value movements due to foreign currency and interest rate risk remeasurement.

Fair value of derivatives									
2024 US\$M	Carrying amount of notes and debentures	Foreign exchange notional at spot rates	Interest rate risk	Recognised in cash flow hedging reserve	Recognised in cost of hedging reserve	Recognised in the income statement <sup>1</sup>	Accrued and other cash flows	Total	Hedged value of notes and debentures <sup>2</sup>
	A	B	C	D	E	F	G	B to G	A + B + C
USD	10,928	–	498	–	–	2	(48)	452	11,426
GBP	1,595	521	247	(13)	3	(69)	(16)	673	2,363
EUR	2,409	367	259	(27)	7	(50)	(286)	270	3,035
<b>Total</b>	<b>14,932</b>	<b>888</b>	<b>1,004</b>	<b>(40)</b>	<b>10</b>	<b>(117)</b>	<b>(350)</b>	<b>1,395</b>	<b>16,824</b>

Fair value of derivatives									
2023 US\$M	Carrying amount of notes and debentures	Foreign exchange notional at spot rates	Interest rate risk	Recognised in cash flow hedging reserve	Recognised in cost of hedging reserve	Recognised in the income statement <sup>1</sup>	Accrued and other cash flows	Total	Hedged value of notes and debentures <sup>2</sup>
	A	B	C	D	E	F	G	B to G	A + B + C
USD	7,245	–	214	–	–	32	23	269	7,459
GBP	1,566	522	274	24	(9)	(69)	35	777	2,362
EUR	3,008	434	302	(39)	10	(49)	(132)	526	3,744
<b>Total</b>	<b>11,819</b>	<b>956</b>	<b>790</b>	<b>(15)</b>	<b>1</b>	<b>(86)</b>	<b>(74)</b>	<b>1,572</b>	<b>13,565</b>

<sup>1</sup> Predominantly related to ineffectiveness.

<sup>2</sup> Includes US\$532 million (2023: US\$534 million) of fixed rate debt not swapped to floating rate that is not in a hedging relationship.

The weighted average interest rate payable is USD SOFR +1.40 per cent (2023: USD SOFR +1.54 per cent). Refer to note 23 'Net finance costs' for details of net finance costs for the year.

#### Movements in reserves relating to hedge accounting

The following table shows a reconciliation of the components of equity and an analysis of the movements in reserves for all hedges. For a description of these reserves, refer to note 18 'Other equity'.

2024 US\$M	Cash flow hedging reserve			Cost of hedging reserve			Total
	Gross	Tax	Net	Gross	Tax	Net	
At the beginning of the financial year	15	(5)	10	(1)	–	(1)	9
Add: Change in fair value of hedging instrument recognised in OCI	(24)	7	(17)	(9)	3	(6)	(23)
Less: Reclassified from reserves to financial expenses – recognised through OCI	49	(15)	34	–	–	–	34
<b>At the end of the financial year</b>	<b>40</b>	<b>(13)</b>	<b>27</b>	<b>(10)</b>	<b>3</b>	<b>(7)</b>	<b>20</b>

2023 US\$M	Cash flow hedging reserve			Cost of hedging reserve			Total
	Gross	Tax	Net	Gross	Tax	Net	
At the beginning of the financial year	59	(18)	41	(27)	8	(19)	22
Add: Change in fair value of hedging instrument recognised in OCI	95	(29)	66	–	–	–	66
Less: Reclassified from reserves to financial expenses – recognised through OCI	(174)	53	(121)	26	(8)	18	(103)
Less: Loss/(gain) transferred to balance sheet related items	35	(11)	24	–	–	–	24
<b>At the end of the financial year</b>	<b>15</b>	<b>(5)</b>	<b>10</b>	<b>(1)</b>	<b>–</b>	<b>(1)</b>	<b>9</b>

#### Changes in interest bearing liabilities and related derivatives resulting from financing activities

The movement in the year in the Group's interest bearing liabilities and related derivatives are as follows:

2024 US\$M	Interest bearing liabilities						Derivatives (assets)/ liabilities	Total
	Bank loans	Notes and debentures	Lease liabilities	Bank overdraft and short-term borrowings	Other	Cross currency and interest rate swaps		
At the beginning of the financial year	7,502	11,819	3,019	5	–	1,572		
Proceeds from interest bearing liabilities	400	4,691	–	–	–	–	5,091	
Settlements of debt related instruments	–	–	–	–	–	(321)	(321)	
Repayment of interest bearing liabilities	(5,319)	(1,338)	(656)	–	(14)	–	(7,327)	
Change from Net financing cash flows	(4,919)	3,353	(656)	–	(14)	(321)	(2,557)	
Other movements:								
Divestment of subsidiaries and operations	–	–	(60)	–	–	–	–	
Interest rate impacts	–	(214)	–	–	–	188	188	
Foreign exchange impacts	24	(35)	(16)	–	–	35	35	
Lease additions	–	–	593	–	–	–	593	
Remeasurement of index-linked freight contracts	–	–	230	–	–	–	230	
Other interest bearing liabilities/derivative related changes	3	9	6	(2)	71	(79)	87	
<b>At the end of the financial year</b>	<b>2,610</b>	<b>14,932</b>	<b>3,116</b>	<b>3</b>	<b>57</b>	<b>1,395</b>	<b>22,013</b>	

2023 US\$M	Interest bearing liabilities					Derivatives (assets)/ liabilities	Total
	Bank loans	Notes and debentures	Lease liabilities	Bank overdraft and short-term borrowings	Other	Cross currency and interest rate swaps	
At the beginning of the financial year	2,472	11,363	2,576	–	17	1,688	
Proceeds from interest bearing liabilities	5,450	2,732	–	–	–	–	8,182
Settlements of debt related instruments	–	–	–	–	–	(677)	(677)
Repayment of interest bearing liabilities	(1,087)	(1,610)	(576)	–	(16)	–	(3,289)
Change from Net financing cash flows	4,363	1,122	(576)	–	(16)	(677)	4,216
Other movements:							
Acquisition of subsidiaries and operations	688	–	423	–	–	–	
Interest rate impacts	–	(803)	–	–	–	691	
Foreign exchange impacts	(23)	128	12	–	–	(127)	
Lease additions	–	–	542	–	–	–	
Remeasurement of index-linked freight contracts	–	–	53	–	–	–	
Other interest bearing liabilities/derivative related changes	2	9	(11)	5	(1)	(3)	
At the end of the financial year	7,502	11,819	3,019	5	–	1,572	

## Employee matters

### 25 Key management personnel

Key management personnel compensation comprises:

	2024 US\$	2023 US\$	2022 US\$
Short-term employee benefits	12,687,272	13,599,217	13,979,139
Post-employment benefits	634,005	659,020	634,363
Share-based payments	11,143,944	11,455,666	11,165,439
<b>Total</b>	<b>24,465,221</b>	<b>25,713,903</b>	<b>25,778,941</b>

Key Management Personnel (KMP) includes the roles which have the authority and responsibility for planning, directing and controlling the activities of BHP. These are Non-executive Directors, the CEO, the Chief Financial Officer, the President Australia and the President Americas.

#### Transactions and outstanding loans/amounts with key management personnel

There were no purchases by key management personnel from the Group during FY2024 (2023: US\$ nil; 2022: US\$ nil).

There were no amounts payable by key management personnel at 30 June 2024 (2023: US\$ nil; 2022: US\$ nil).

There were no loans receivable from or payable to key management personnel at 30 June 2024 (2023: US\$ nil; 2022: US\$ nil).

#### Transactions with personally related entities

A number of Directors of the Group hold or have held positions in other companies (personally related entities) where it is considered they control or significantly influence the financial or operating policies of those entities. There were no reportable transactions with those entities and no amounts were owed by the Group to personally related entities at 30 June 2024 (2023: US\$ nil; 2022: US\$ nil).

For more information on remuneration and transactions with key management personnel, refer to the Remuneration Report under Governance.

### 26 Employee share ownership plans

Awards, in the form of the right to receive ordinary shares in BHP Group Limited have been granted under the following employee share ownership plans: Cash and Deferred Plan (CDP), Long-Term Incentive Plan (LTIP), Management Award Plan (MAP) and the all-employee share plan, Shareplus.

Some awards are eligible to receive a cash payment, or the equivalent value in shares, equal to the dividend amount that would have been earned on the underlying shares awarded to those participants (the Dividend Equivalent Payment, or DEP). The DEP is provided to the participants once the underlying shares are allocated or transferred to them. Awards under the plans do not confer any rights to participate in a share issue; however, there is discretion under each of the plans to adjust the awards in response to a variation in the share capital of BHP Group Limited.

The table below provides a description of each of the plans.

<b>Plan Type</b>	<b>CDP</b>	<b>LTIP and MAP</b>	<b>Shareplus</b>
<b>Overview</b>	<p>The CDP is a plan for Executive KMP and members of the Executive Leadership Team who are not Executive KMP.</p> <p>Generally under the CDP, two thirds of the value of a participant's short-term incentive amount is awarded as rights to receive BHP Group Limited shares at the end of the vesting period (and the remaining one third is delivered in cash). Two awards of deferred shares are granted, each of the equivalent value to the cash award, vesting between two and five years respectively. Awards of deferred shares may also be granted to members of the Executive Leadership Team as additional retention awards with vesting periods of up to five years.</p>	<p>The LTIP is a plan for Executive KMP and members of the Executive Leadership Team who are not Executive KMP, and awards are granted annually.</p> <p>The MAP is a plan for BHP senior management who are not Executive KMP. The number of share rights awarded is determined by a participant's role and grade.</p>	<p>Employees may contribute up to US\$5,000 to acquire shares in any plan year. On the third anniversary of the start of a plan year, the Group will match the number of acquired shares.</p>
<b>Vesting conditions</b>	<p>Service conditions only for the two-year award. Vesting of the four-year awards are subject to service and individual performance conditions. Vesting of the five-year awards are subject to service conditions and also to a holistic review of performance at the end of the five-year vesting period, including a five-year view on Safety and Sustainability performance, profitability, cash flow, balance sheet health, returns to shareholders, corporate governance and conduct.</p>	<p>LTIP: Service and performance conditions.</p> <p>From FY2023 BHP's Total Shareholder Return<sup>1</sup> (TSR) performance relative to two Morgan Stanley Capital International (MSCI) market indices, the MSCI World Metals and Mining Index ("Sector Group TSR") and the MSCI World Index ("World TSR"). The Sector Group TSR over a five-year performance period determines the vesting of 67 per cent of the awards, while performance relative to the World TSR determines the vesting of 33 per cent of the awards. For awards granted prior to FY2023, TSR performance relative to a bespoke sector peer group and the MSCI World Index determines the vesting of 67 per cent and 33 per cent of the award, respectively.</p> <p>25 per cent of the award will vest where BHP's TSR is equal to the median TSR of the relevant comparator group(s), as measured over the performance period. Where TSR is below the median, awards will not vest. Vesting occurs on a sliding scale when BHP's TSR measured over the performance period is between the median TSR of the relevant comparator group(s) up to a nominated level of TSR outperformance over the relevant comparator group(s), as determined by the Committee, above which 100 per cent of the award will vest.</p> <p>MAP: Service conditions only.</p>	<p>Service conditions only.</p>
<b>Vesting period</b>	Between 2 and 5 years	<p>LTIP – 5 years</p> <p>MAP – 1 to 5 years</p>	3 years
<b>Dividend Equivalent Payment</b>	Yes	<p>LTIP – Yes</p> <p>MAP – Varies</p>	No
<b>Exercise period</b>	None	None	None

<sup>1</sup> For LTIP awards granted prior to unification and where the five-year performance period ends after unification, the TSR at the start of the performance period is based on the weighted average of the TSRs of BHP Group Limited and BHP Group Plc and the TSR at the end of the performance period is based on the TSR of BHP Group Limited.

## Employee share awards

2024	Number of awards at the beginning of the financial year	Number of awards issued during the year	Number of awards vested and exercised	Number of awards lapsed	Number of awards at the end of the financial year	Weighted average remaining contractual life (years)	Weighted average share price at exercise date
CDP awards	968,581	532,680	219,701	70,071	1,211,489	2.1	A\$43.02
LTIP awards	2,558,796	564,431	520,443	177,078	2,425,706	2.2	A\$43.02
MAP awards <sup>1</sup>	6,653,726	2,515,913	2,626,587	555,855	5,987,197	1.2	A\$43.33
Shareplus	5,123,851	2,457,307	2,460,834	607,438	4,512,886	1.2	A\$44.35

<sup>1</sup> There were 75,457 awards vested and exercisable at the end of the financial year.

## Fair value and assumptions in the calculation of fair value for awards issued

2024	Weighted average fair value of awards granted during the year US\$	Risk-free interest rate	Estimated life of awards	Share price at grant date	Estimated volatility of share price	Dividend yield
CDP awards <sup>1</sup>	29.71	n/a	2-5 years	A\$44.70/A\$42.75	n/a	n/a
LTIP awards	19.51	4.23%	5 years	A\$44.70	33.61%	n/a
MAP awards <sup>2</sup>	23.95	n/a	1-5 years	A\$43.49/A\$47.74/A\$45.52/A\$42.75	n/a	5.21%/5.60%/7.44%
Shareplus	24.40	n/a	3 years	A\$47.23	n/a	7.41%

<sup>1</sup> Includes CDP awards granted on 8 December 2023 and 20 June 2024.

<sup>2</sup> Includes MAP awards granted on 27 September 2023, 8 December 2023, 12 April 2024 and 20 June 2024.

## Recognition and measurement

The fair value at grant date of equity-settled share awards is charged to the income statement over the period for which the benefits of employee services are expected to be derived. The fair values of awards granted were estimated using a Monte Carlo simulation methodology and Black-Scholes option pricing technique and consider the following factors:

- exercise price
- expected life of the award
- current market price of the underlying shares
- expected volatility using an analysis of historic volatility over different rolling periods. For the LTIP, it is calculated for all sector comparators and the published MSCI World Index
- expected dividends
- risk-free interest rate, which is an applicable government bond rate
- market-based performance hurdles
- non-vesting conditions

Where awards are forfeited because non-market-based vesting conditions are not satisfied, the expense previously recognised is proportionately reversed.

The tax effect of awards granted is recognised in income tax expense, except to the extent that the total tax deductions are expected to exceed the cumulative remuneration expense. In this situation, the excess of the associated current or deferred tax is recognised in equity and forms part of the employee share awards reserve. The fair value of awards as presented in the tables above represents the fair value at grant date.

In respect of employee share awards, the Group utilises the BHP Group Limited Employee Equity Trust. The trustee of this trust is an independent company, resident in Jersey. The trust uses funds provided by the Group to acquire ordinary shares to enable awards to be made or satisfied. The ordinary shares may be acquired by purchase in the market or by subscription at not less than nominal value.

## 27 Employee benefits, restructuring and post-retirement employee benefits provisions

	2024	2023
	US\$M	US\$M
Employee benefits <sup>1</sup>	1,698	1,749
Restructuring <sup>2</sup>	45	28
Post-retirement employee benefits <sup>3</sup>	300	373
<b>Total provisions</b>	<b>2,043</b>	<b>2,150</b>
Comprising:		
Current	1,677	1,734
Non-current	366	416

2024	Employee benefits US\$M	Restructuring US\$M	Post- retirement employee benefits <sup>3</sup> US\$M	Total US\$M
At the beginning of the financial year	1,749	28	373	2,150
Charge/(credit) for the year:				
Underlying	1,375	55	65	1,495
Discounting	–	–	21	21
Yield on defined benefit scheme assets	–	–	(4)	(4)
Exchange variations	(21)	–	(45)	(66)
Released during the year	(98)	(10)	(1)	(109)
Remeasurement gains taken to retained earnings	–	–	(41)	(41)
Utilisation	(1,268)	(27)	(68)	(1,363)
Divestment of subsidiaries and operations <sup>4</sup>	(39)	–	–	(39)
Transfers and other movements	–	(1)	–	(1)
<b>At the end of the financial year</b>	<b>1,698</b>	<b>45</b>	<b>300</b>	<b>2,043</b>

<sup>1</sup> The expenditure associated with total employee benefits will occur in a pattern consistent with when employees choose to exercise their entitlement to benefits.

<sup>2</sup> Total restructuring provisions include provisions for terminations and office closures.

<sup>3</sup> The net liability recognised in the Consolidated Balance Sheet includes US\$142 million present value of funded defined benefits pension obligation (2023: US\$151 million) offset by fair value of defined benefit scheme assets US\$(147) million (2023: US\$(159) million), US\$63 million present value of unfunded defined pension and post-retirement medical benefits obligation (2023: US\$79 million) and US\$242 million unfunded post-employment benefits obligation in Chile (2023: US\$302 million).

<sup>4</sup> Relates to the divestment of the Blackwater and Daunia mines completed on 2 April 2024. Refer to note 3 'Exceptional items' for more information.

### Recognition and measurement

Provisions are recognised by the Group when:

- there is a present legal or constructive obligation as a result of past events
- it is more likely than not that a permanent outflow of resources will be required to settle the obligation
- the amount can be reliably estimated and measured at the present value of management's best estimate of the cash outflow required to settle the obligation at the reporting date



**Provision****Description****Employee benefits**

Liabilities for benefits accruing to employees up until the reporting date in respect of wages and salaries, annual leave and any accumulating sick leave are recognised in the period the related service is rendered.

Liabilities recognised in respect of short-term employee benefits expected to be settled within 12 months are measured at the amounts expected to be paid when the liabilities are settled.

Liabilities for other long-term employee benefits, including long service leave, are measured as the present value of estimated future payments for the services provided by employees up to the reporting date.

Liabilities that are not expected to be settled within 12 months are discounted at the reporting date using market yields of high-quality corporate bonds or government bonds for countries where there is no deep market for corporate bonds. The rates used reflect the terms to maturity and currency that match, as closely as possible, the estimated future cash outflows.

In relation to industry-based long service leave funds, the Group's liability, including obligations for funding shortfalls, is determined after deducting the fair value of dedicated assets of such funds.

Liabilities for short and long-term employee benefits (other than unpaid wages and salaries) are disclosed within employee benefits.

Other liabilities for unpaid wages and salaries related to the current period are recognised in other creditors.

**Review of employee allowances and entitlements**

On 1 June 2023, the Group disclosed the identification of two issues with certain allowances and entitlements affecting a number of current and former employees in Australia. The identified issues relate to rostered employees having leave incorrectly deducted on public holidays since 2010 (leave issue) and certain employees at Port Hedland being eligible for additional allowances due to an error with the employing entity in their employment documentation (employing entity issue). The Group self-reported the issues to the Fair Work Ombudsman in Australia.

Since the date of the announcement, the Group has reccredited leave hours to current employees and begun making payments to former employees who were impacted by the leave issue.

The Group has also commenced making payments to current and former employees for historical impacts of the employing entity issue in the first quarter of FY2025.

The Group's best estimate of the remaining cost of remediating the two issues, incorporating on-costs, including associated superannuation and interest payments (BHP share) is reflected in employee benefit provisions at 30 June 2024.

There remains a risk that other instances of non-compliance requiring remediation may be identified through the Group's review processes and associated provisions may be recognised in future reporting periods.

**Restructuring**

Restructuring provisions are recognised when:

- the Group has developed a detailed formal plan identifying the business or part of the business concerned, the location and approximate number of employees affected, a detailed estimate of the associated costs, and an appropriate timeline
- the restructuring has either commenced or been publicly announced and can no longer be withdrawn

Payments that are not expected to be settled within 12 months of the reporting date are measured at the present value of the estimated future cash payments expected to be made by the Group.

Provision	Description
Post-retirement employee benefits	<p><b>Defined contribution pension schemes and multi-employer pension schemes</b></p> <p>For defined contribution schemes or schemes operated on an industry-wide basis where it is not possible to identify assets attributable to the participation by the Group's employees, the pension charge is calculated on the basis of contributions payable. The Group contributed US\$368 million during the financial year (2023: US\$358 million; 2022: US\$324 million) to defined contribution plans and multi-employer defined contribution plans. These contributions are expensed as incurred.</p> <p><b>Defined benefit pension and post-retirement medical schemes</b></p> <p>The Group operates or participates in a number of defined benefit pension schemes throughout the world, all of which are closed to new entrants. The funding of the schemes complies with local regulations. The assets of the schemes are generally held separately from those of the Group and are administered by trustees or management boards. The Group also operates a number of unfunded post-retirement medical schemes in the United States, Canada and Europe.</p> <p>For defined benefit schemes, an asset or liability is recognised in the balance sheet based at the present value of defined benefit obligations less, where funded, the fair value of plan assets, except that any such asset cannot exceed the present value of expected refunds from and reductions in future contributions to the plan. Full actuarial valuations are prepared by local actuaries for all schemes, using discount rates based on market yields at the reporting date on high-quality corporate bonds or by reference to national government bonds if high-quality corporate bonds are not available.</p> <p>Where funded, scheme assets are invested in a diversified range of asset classes, predominantly comprising bonds and equities.</p>

## Group and related party information

### 28 Discontinued operations

On 1 June 2022 (Completion date) BHP completed the merger of the Group's oil and gas portfolio with Woodside Energy Group Limited ('Woodside'). Woodside acquired the entire share capital of BHP Petroleum International Pty Ltd ('BHP Petroleum') in exchange for 914,768,948 newly issued Woodside ordinary shares.

On the Completion Date, the Group paid a fully franked in specie dividend in the form of Woodside shares to eligible BHP shareholders. Eligible BHP shareholders received one Woodside share for every 5.5340 BHP shares they held on the Group's register at the record date of 26 May 2022.

As part of completion and in order to reflect the economic effective date of 1 July 2021, the Group made a net cash payment of US\$0.7 billion (net of completion adjustments) to Woodside in addition to US\$0.4 billion in cash that was left in the BHP Petroleum bank accounts to fund ongoing operations. The total cash transfer of US\$1.1 billion reflected the net cash flows generated by BHP Petroleum between 1 July 2021 and Completion Date adjusted for dividends Woodside would have paid on the newly issued Woodside ordinary shares, had the Merger completed on 1 July 2021.

There was no contribution of Discontinued operations to the Group's profit and cash flows for years ended 30 June 2024 and 30 June 2023. The Blackwater and Daunia mines, while being divested on 2 April 2024, are not considered to meet the criteria for classification as a Discontinued operation given their relative size to the Group and the Coal segment. For further information, refer to note 3 'Exceptional items'.

The contribution of Discontinued operations for the year ended 30 June 2022 is detailed below:

#### Income statement – Discontinued operations

	2022
	US\$M
Profit/(loss) after taxation from operating activities	2,496
Net gain on Petroleum merger with Woodside (after tax)	8,159
Profit/(loss) after taxation	10,655
Attributable to non-controlling interests	–
Attributable to BHP shareholders	10,655
Basic earnings/(loss) per ordinary share (cents)	210.5
Diluted earnings/(loss) per ordinary share (cents)	210.1

The total comprehensive income attributable to BHP shareholders from Discontinued operations was a gain of US\$10,596 million for the year ended 30 June 2022.

## Cash flows from Discontinued operations

	2022 US\$M
Net operating cash flows	2,889
Net investing cash flows <sup>1</sup>	(904)
Net financing cash flows <sup>2</sup>	(33)
Net increase/(decrease) in cash and cash equivalents from Discontinued operations	1,952
Net cash completion payment on merger of Petroleum with Woodside	(683)
Cash and cash equivalents disposed	(399)
<b>Total cash impact</b>	<b>870</b>

<sup>1</sup> Includes purchases of property, plant and equipment and capitalised exploration related to drilling and development expenditure of US\$1,144 million, proceeds from sale of subsidiaries, operations and joint operations, net of cash of US\$91 million, proceeds from sale of assets of US\$151 million and other investing outflows of US\$2 million.

<sup>2</sup> Represents net repayment of interest bearing liabilities of US\$33 million.

## Exceptional items – Discontinued operations

Exceptional items are those gains or losses where their nature, including the expected frequency of the events giving rise to them, and impact is considered material to the Financial Statements.

There were no exceptional items related to Discontinued operations for years ended 30 June 2024 and 30 June 2023.

The Exceptional item related to Discontinued operations included within the Group's profits for the year ended 30 June 2022 is detailed below.

Year ended 30 June 2022	Gross US\$M	Tax US\$M	Net US\$M
<b>Exceptional items by category</b>			
Net gain on Petroleum merger with Woodside <sup>1</sup>	8,167	(8)	8,159
<b>Total</b>	<b>8,167</b>	<b>(8)</b>	<b>8,159</b>
Attributable to non-controlling interests	–	–	–
Attributable to BHP shareholders	8,167	(8)	8,159

<sup>1</sup> The tax expense associated with the exceptional item reflects the tax impact of transaction costs and other restructuring related activities undertaken pre-merger. There were no further tax impacts arising on the net gain on merger of our Petroleum business with Woodside as generated tax losses were either offset with capital gains in other entities in the Group, or not recognised on the basis that it is not probable that future capital gains will be available against which the Group can utilise the tax losses.

## Net gain on disposal of Discontinued operations

Details of the net gain on Petroleum merger with Woodside is presented below:

	2022 US\$M
Net assets disposed	10,172
Fair value of Woodside shares <sup>1</sup>	19,566
Net cash completion payment on merger of Petroleum with Woodside <sup>2</sup>	(683)
Foreign currency translation reserve transferred to the income statement	54
Other provisions and related indemnities recognised at completion	(353)
Transaction and other directly attributable costs	(245)
Income tax expense	(8)
<b>Net gain on Petroleum merger with Woodside</b>	<b>8,159</b>

<sup>1</sup> Represents the consideration received being the fair value of 914,768,948 Woodside ordinary shares received using the closing ASX share price of A\$29.76 on 31 May 2022 (US\$21.39 equivalent based on an exchange rate of AUD/USD 0.7187).

<sup>2</sup> Reflects the net cash flows generated by BHP Petroleum between 1 July 2021 and Completion Date adjusted for dividends Woodside would have paid on the newly issued Woodside ordinary shares, had the Merger completed on 1 July 2021.

## 29 Business combinations

There were no business combinations entered into by the Group during the year ended 30 June 2024.

### Business combination during the year ended 30 June 2023

#### OZ Minerals Limited

On 2 May 2023 (Acquisition Date), the Group acquired 100 per cent of the issued share capital of OZ Minerals Limited (OZL) for a net cash consideration of US\$5.9 billion. The terms of the acquisition did not include any contingent consideration.

The Group had 12 months from the acquisition date to make adjustments in the current period to the fair value of net identifiable assets acquired and the resultant value of goodwill with no restatement of comparative information. As at 2 May 2024, the Group finalised the purchase price allocation which has resulted in a net increase of US\$2 million in goodwill from the provisional amount reported at 30 June 2023.

Details of the business combination are as follows:

	<b>Final Fair value US\$M</b>
<b>Assets</b>	
Cash and cash equivalents	104
Trade and other receivables <sup>1</sup>	77
Other financial assets	7
Inventories	329
Property, plant and equipment	7,661
Intangible assets – goodwill	194
Current tax receivable	36
Other assets	25
<b>Total assets</b>	<b>8,433</b>
<b>Liabilities</b>	
Trade and other payables	242
Interest bearing liabilities	1,111
Deferred tax liabilities <sup>2</sup>	850
Provisions	258
<b>Total liabilities</b>	<b>2,461</b>
<b>Identifiable net assets acquired</b>	<b>5,972</b>
Total consideration paid <sup>3 4</sup>	5,972
Cash and cash equivalents acquired	(104)
<b>Net cash consideration paid</b>	<b>5,868</b>

<sup>1</sup> This represents the gross contractual amount for trade and other receivables all of which is expected to be collected.

<sup>2</sup> This primarily represents the difference between the fair value of the mineral rights acquired and the corresponding tax base.

<sup>3</sup> The Group executed a forward exchange contract to hedge the foreign exchange exposure on the consideration made in AUD. On maturity of the hedging instrument, a hedge loss of US\$35 million was capitalised to the cost of the acquisition.

<sup>4</sup> The consideration paid by the Group was A\$26.50 (at the average hedged exchange rate of AUD/USD 0.6681) per OZL share over 337,314,920 shares and excluded a special dividend of A\$1.75 per OZL share which was paid by OZL to its shareholders immediately prior to acquisition.

Goodwill of US\$194 million represented the excess of consideration paid above the fair value of the acquired assets and liabilities. The goodwill primarily arises from the deferred tax liability recognised at acquisition due to a difference between the fair value of mineral rights acquired and the corresponding tax base.

None of the goodwill recognised is expected to be deductible for tax purposes.

During 2024, US\$1,094 million of goodwill and property, plant and equipment recognised as part of the OZL business combination has been impaired. Refer to note 13 'Impairment of non-current assets' for information on impairments.

#### Key judgements and estimates

*Judgements:* Judgement is required to determine the fair value of assets acquired and liabilities assumed at acquisition date in a business combination, which could have a material impact on goodwill.

*Estimates:* The Group used the discounted cash-flow method to measure the fair value of mineral rights. Key assumptions used included commodity prices, production volumes, life of mine, cash outflows (including operating costs, capital expenditure, closure and rehabilitation costs and taxes), discount rates and risk factors.

### 30 Subsidiaries

Significant subsidiaries of the Group are those with the most significant contribution to the Group's net profit or net assets. The Group's interest in the subsidiaries' results are listed in the table below. For a list of the Group's subsidiaries, refer to Exhibit 8.1 – List of Subsidiaries.

Significant subsidiaries	Country of incorporation	Principal activity	Group's interest	
			2024 %	2023 %
<b>Coal</b>				
Hunter Valley Energy Coal Pty Ltd	Australia	Coal mining	100	100
<b>Copper</b>				
BHP Olympic Dam Corporation Pty Ltd	Australia	Copper, uranium and gold mining	100	100
Compañía Minera Cerro Colorado Limitada	Chile	Copper mining	100	100
Minera Escondida Ltda <sup>1</sup>	Chile	Copper mining	57.5	57.5
Minera Spence SA	Chile	Copper mining	100	100
OZ Minerals Carrapateena Pty Ltd	Australia	Copper and gold mining	100	100
OZ Minerals Prominent Hill Operations Pty Ltd	Australia	Copper and gold mining	100	100
<b>Iron Ore</b>				
BHP Iron Ore (Jimblebar) Pty Ltd <sup>2</sup>	Australia	Iron ore mining	85	85
BHP Iron Ore Pty Ltd	Australia	Service company	100	100
BHP (Towage Service) Pty Ltd	Australia	Towing services	100	100
<b>Marketing</b>				
BHP Billiton Freight Singapore Pte Limited	Singapore	Freight services	100	100
BHP Billiton Marketing AG	Switzerland	Marketing and trading	100	100
BHP Billiton Marketing Asia Pte Ltd	Singapore	Marketing support and other services	100	100
<b>Group and Unallocated</b>				
BHP Billiton Finance B.V.	The Netherlands	Finance	100	100
BHP Billiton Finance Limited	Australia	Finance	100	100
BHP Billiton Finance (USA) Limited	Australia	Finance	100	100
BHP Canada Inc.	Canada	Potash development	100	100
BHP Group Operations Pty Ltd	Australia	Administrative services	100	100
BHP Nickel West Pty Ltd	Australia	Nickel mining, smelting, refining and administrative services	100	100
OZ Minerals Musgrave Operations Pty Ltd	Australia	Nickel and copper development	100	100
WMC Finance (USA) Limited	Australia	Finance	100	100

<sup>1</sup> As the Group has the ability to direct the relevant activities at Minera Escondida Ltda, it has control over the entity. The assessment of the most relevant activity in this contractual arrangement is subject to judgement. The Group establishes the mine plan and the operating budget and has the ability to appoint the key management personnel, demonstrating that the Group has the existing rights to direct the relevant activities of Minera Escondida Ltda.

<sup>2</sup> The Group has an effective interest of 92.5 per cent in BHP Iron Ore (Jimblebar) Pty Ltd; however, by virtue of the shareholder agreement with ITOCHU Iron Ore Australia Pty Ltd and Mitsui & Co. Iron Ore Exploration & Mining Pty Ltd, the Group's interest in the Jimblebar mining operation is 85 per cent, which is consistent with the other respective contractual arrangements at Western Australia Iron Ore.

### 31 Investments accounted for using the equity method

Significant interests in equity accounted investments of the Group are those with the most significant contribution to the Group's net profit or net assets. The Group's ownership interest in significant equity accounted investments results are listed in the table below. For a list of the Group's associates and joint ventures, refer to Exhibit 8.1 – List of Subsidiaries.

Significant associates and joint ventures	Country of incorporation/ principal place of business	Associate or joint venture	Principal activity	Reporting date	Ownership interest	
					2024 %	2023 %
Compañía Minera Antamina S.A. (Antamina)	Peru	Associate	Copper and zinc mining	31 December	33.75	33.75
Samarco Mineração S.A. (Samarco)	Brazil	Joint venture	Iron ore mining	31 December	50.00	50.00

Voting in relation to relevant activities in Antamina, determined to be the approval of the operating and capital budgets, does not require unanimous consent of all participants to the arrangement, therefore joint control does not exist. Instead, because the Group has the power to participate in the financial and operating policies of the investee, this investment is accounted for as an associate.

Samarco is jointly owned by BHP Billiton Brasil Ltda (BHP Brasil) and Vale S.A. (Vale). As the Samarco entity has the rights to the assets and obligations to the liabilities relating to the joint arrangement and not its owners, this investment is accounted for as a joint venture.

The Group is restricted in its ability to make dividend payments from its investments in associates and joint ventures as any such payments require the approval of all investors in the associates and joint ventures. The ownership interest at the Group's and the associates' or joint ventures' reporting dates are the same. When the annual financial reporting date is different to the Group's, financial information is obtained as at 30 June in order to report on an annual basis consistent with the Group's reporting date.

The movement for the year in the Group's investments accounted for using the equity method is as follows:

Year ended 30 June 2024 USSM	Investment in associates	Investment in joint ventures	Total equity accounted investments
At the beginning of the financial year	1,620	–	1,620
(Loss)/profit from equity accounted investments, related impairments and expenses <sup>1</sup>	376	(3,032)	(2,656)
Investment in equity accounted investments	63	–	63
Dividends received from equity accounted investments	(397)	–	(397)
Other <sup>1</sup>	–	3,032	3,032
<b>At the end of the financial year</b>	<b>1,662</b>	<b>–</b>	<b>1,662</b>

<sup>1</sup> Represents financial impacts of Samarco dam failure in the Group's loss from equity accounted investments, related impairments and expenses. Refer to note 4 'Significant events – Samarco dam failure' for further information.



2022 US\$M	Associates		Joint ventures		Total
	Antamina	Individually immaterial	Samarco <sup>2</sup>	Individually immaterial	
Revenue – 100%	5,264		1,670		
Profit/(loss) from Continuing operations – 100%	2,133		(528) <sup>(10)</sup>		
Share of profit/(loss) of equity accounted investments	720		(276)		
Impairment of the carrying value of the investment in Samarco	–		–		
Additional share of Samarco losses	–		290		
Fair value change on forward exchange derivatives	–		(81)		
Movement in unrecognised losses	–		(609) <sup>(9)</sup>		
Profit/(loss) from equity accounted investments, related impairments and expenses	720	(63)	(676)	–	(19)
Comprehensive income – 100%	2,133		(528)		
Share of comprehensive income/(loss) – Group share in equity accounted investments	720	(63)	(676)	–	(19)
Dividends received from equity accounted investments	776	11	–	–	787

<sup>1</sup> The unrecognised share of gain for the period was US\$41 million (2023: unrecognised share of gain for the period was US\$76 million), which decreased the cumulative losses to US\$100 million (2023: decrease to US\$141 million).

<sup>2</sup> Refer to note 4 ‘Significant events – Samarco dam failure’ for further information regarding the financial impact of the Samarco dam failure which occurred in November 2015 on BHP Brasil’s share of Samarco’s losses. The financial information disclosed represents the underlying financial information of Samarco updated to reflect the Group’s best estimate of the costs to resolve all aspects of the Federal Public Prosecution Office claim and Framework Agreement.

<sup>3</sup> Includes cash and cash equivalents of US\$251 million (2023: US\$138 million).

<sup>4</sup> Includes current financial liabilities (excluding trade and other payables and provisions) of US\$ nil (2023: US\$7,154 million).

<sup>5</sup> Relates mainly to dividends declared by Samarco that remain unpaid at balance date and which, in accordance with the Group’s accounting policy, are recognised when received not receivable.

<sup>6</sup> Any working capital funding provided to Samarco is capitalised as part of the Group’s investments in joint ventures and disclosed as an impairment included within the Samarco impairment expense line item.

<sup>7</sup> In the year ended 30 June 2016 BHP Brasil adjusted its investment in Samarco to US\$ nil (resulting from US\$(655) million share of loss from Samarco and US\$(525) million impairment). Additional cumulative impairment losses relating to working capital funding of US\$(516) million have also been recognised.

<sup>8</sup> BHP Brasil has recognised accumulated additional share of Samarco losses of US\$(7,891) million resulting from US\$(6,147) million provisions relating to the Samarco dam failure and US\$(1,744) million recognised as net finance costs.

<sup>9</sup> Share of Samarco’s losses for which BHP Brasil does not have an obligation to fund.

<sup>10</sup> Includes depreciation and amortisation of US\$165 million (2023: US\$144 million; 2022: US\$205 million), interest income of US\$43 million (2023: US\$42 million; 2022: US\$19 million), interest expense of US\$807 million (2023: US\$1,384 million; 2022: US\$628 million), other finance income in relation to the Judicial Reorganisation of US\$1,756 million (2023: US\$ nil; 2022: US\$ nil) and income tax benefit/(expense) of US\$999 million (2023: US\$(213) million; 2022: US\$(7) million).

<sup>11</sup> Includes accounting policy adjustments mainly related to the removal of foreign exchange gains on excluded dividends payable.



## 32 Interests in joint operations

Significant joint operations of the Group are those with the most significant contributions to the Group's net profit or net assets. The Group's interest in the joint operations results are listed in the table below. For a list of the Group's investments in joint operations, refer to Exhibit 8.1 – List of Subsidiaries.

Significant joint operations	Country of operation	Principal activity	Group's interest	
			2024	2023
			%	%
Mt Goldsworthy <sup>1</sup>	Australia	Iron ore mining	85	85
Mt Newman <sup>1</sup>	Australia	Iron ore mining	85	85
Yandi <sup>1</sup>	Australia	Iron ore mining	85	85
Central Queensland Coal Associates	Australia	Coal mining	50	50

<sup>1</sup> These contractual arrangements are controlled by the Group and do not meet the definition of joint operations. However, as they are formed by contractual arrangement and are not entities, the Group recognises its share of assets, liabilities, revenue and expenses arising from these arrangements.

Assets held in joint operations subject to significant restrictions are as follows:

	Group's share	
	2024	2023
	US\$M	US\$M
Current assets	1,928	1,561
Non-current assets	25,307	26,370
<b>Total assets<sup>1</sup></b>	<b>27,235</b>	<b>27,931</b>

<sup>1</sup> While the Group is unrestricted in its ability to sell a share of its interest in these joint operations, it does not have the right to sell individual assets that are used in these joint operations without the unanimous consent of the other participants. The assets in these joint operations are also restricted to the extent that they are only available to be used by the joint operation itself and not by other operations of the Group.

## 33 Related party transactions

The Group's related parties are predominantly subsidiaries, associates and joint ventures, and key management personnel of the Group. Disclosures relating to key management personnel are set out in note 25 'Key management personnel'. Transactions between each parent company and its subsidiaries are eliminated on consolidation and are not disclosed in this note.

- All transactions to/from related parties are made at arm's length, i.e. at normal market prices and rates and on normal commercial terms.
- Outstanding balances at year-end are unsecured and settlement occurs in cash. Loan amounts owing from related parties represent secured loans made to associates and joint ventures under co-funding arrangements. Such loans are made on an arm's length basis.
- No guarantees are provided or received for any related party receivables or payables.
- No provision for expected credit losses has been recognised in relation to any outstanding balances and no expense has been recognised in respect of expected credit losses due from related parties.
- There were no other related party transactions in the year ended 30 June 2024 (2023: US\$ nil), other than those with post-employment benefit plans for the benefit of Group employees. These are shown in note 27 'Employee benefits, restructuring and post-retirement employee benefits provisions'.
- Related party transactions with Samarco are described in note 4 'Significant events – Samarco dam failure'.

Further disclosures related to related party transactions are as follows:

### Transactions with related parties

	Joint ventures		Associates	
	2024	2023	2024	2023
	US\$M	US\$M	US\$M	US\$M
Sales of goods/services	–	–	–	–
Purchases of goods/services	–	–	1,606.639	1,589.094
Interest income	–	–	–	–
Interest expense	–	–	–	–
Dividends received	–	–	396.856	327.679
Net loans made to/(repayments from) related parties	–	–	–	–

### Outstanding balances with related parties

	Joint ventures		Associates	
	2024	2023	2024	2023
	US\$M	US\$M	US\$M	US\$M
Trade amounts owing to related parties	–	–	246.764	246.239
Loan amounts owing to related parties	–	–	–	–
Trade amounts owing from related parties	–	–	0.249	6.730
Loan amounts owing from related parties	–	–	–	–

## Unrecognised items and uncertain events

### 34 Contingent liabilities

	2024	2023
	US\$M	US\$M
Associates and joint ventures <sup>1</sup>	1,492	1,094
Subsidiaries and joint operations <sup>1</sup>	859	1,184
<b>Total</b>	<b>2,351</b>	<b>2,278</b>

<sup>1</sup> There are a number of matters, for which it is not possible at this time to provide a range of possible outcomes or a reliable estimate of potential future exposures, and for which no amounts have been included in the table above.

A contingent liability is a possible obligation arising from past events and whose existence will be confirmed only by occurrence or non-occurrence of one or more uncertain future events not wholly within the control of the Group. A contingent liability may also be a present obligation arising from past events but is not recognised on the basis that an outflow of economic resources to settle the obligation is not viewed as probable, or the amount of the obligation cannot be reliably measured.

When the Group has a present obligation, an outflow of economic resources is assessed as probable and the Group can reliably measure the obligation, a provision is recognised.

The Group has entered into various counter-indemnities of bank and performance guarantees related to its own future performance, which are in the normal course of business. The likelihood of these guarantees being called upon is considered remote.

The Group presently has tax matters, litigation and other claims, for which the timing of resolution and potential economic outflow are uncertain. Obligations assessed as having probable future economic outflows capable of reliable measurement are provided at reporting date and matters assessed as having possible future economic outflows capable of reliable measurement are included in the total amount of contingent liabilities above. Individually significant matters, including narrative on potential future exposures incapable of reliable measurement, are disclosed below, to the extent that disclosure does not prejudice the Group.

#### **Uncertain tax and royalty matters**

The Group is subject to a range of taxes and royalties across many jurisdictions, the application of which is uncertain in some regards. Changes in tax law, changes in interpretation of tax law, periodic challenges and disagreements with tax authorities, and legal proceedings result in uncertainty of the outcome of the application of taxes and royalties to the Group's business.

To the extent uncertain tax and royalty matters give rise to a contingent liability, an estimate of the potential liability is included within the table above, where it is capable of reliable measurement.

#### **Samarco contingent liabilities**

The table above includes contingent liabilities related to the Group's equity accounted investment in Samarco to the extent they are capable of reliable measurement. Details of contingent liabilities related to Samarco are disclosed in note 4 'Significant events – Samarco dam failure'.

#### **Divestments and demergers**

Where the Group divests or demerges entities, it is generally agreed to provide certain indemnities to the acquiring or demerged entity. Such indemnities include those provided as part of the demerger of South32 Ltd in May 2015, divestment of Group's Onshore US assets in September 2018 and October 2018, divestment of BMC in May 2022 and the merger of the Group's Petroleum business with Woodside in June 2022. No material claims have been made pursuant to these indemnities as at 30 June 2024.

### 35 Subsequent events

On 30 July 2024, the Group announced an agreement with Lundin Mining to jointly acquire 100% of Filo Corp., a Toronto Stock Exchange listed company which owns the Filo del Sol (FDS) copper project. BHP and Lundin Mining also agreed to form a 50/50 joint venture to hold the FDS and Josemaria projects located in the Vicuña district of Argentina and Chile (together with the Filo Acquisition, the Proposed Transaction). Lundin Mining owns 100% of the Josemaria project. BHP's total cash payment for the Proposed Transaction is expected to be approximately US\$2.1 billion. In connection with the Filo Acquisition, BHP and Lundin Mining have also agreed to subscribe for 3,484,848 common shares of Filo Corp. at a price of C\$33.00 per share for aggregate gross proceeds of C\$115 million (the Filo Share Placement) to provide interim financing to Filo Corp.

Other than the matters outlined above or elsewhere in the Financial Statements, no matters or circumstances have arisen since the end of the financial year that have significantly affected, or may significantly affect, the operations, results of operations or state of affairs of the Group in subsequent accounting periods.

## Other items

### 36 Auditor's remuneration

	<u>2024</u>	<u>2023</u>	<u>2022</u>
	US\$M	US\$M	US\$M
<b>Fees payable to the Group's auditors for assurance services</b>			
Audit of the Group's Annual Report	10.558	9.700	9.816
Audit of the accounts of subsidiaries, joint ventures and associates	0.534	0.551	0.605
Audit-related assurance services required by legislation to be provided by the auditor	1.871	1.808	1.933
Other assurance and agreed-upon procedures under legislation or contractual arrangements	2.261	1.991	7.938
<b>Total assurance services</b>	<b>15.224</b>	<b>14.050</b>	<b>20.292</b>
<b>Fees payable to the Group's auditors for non-assurance services</b>			
Other services	0.498	0.180	–
<b>Total other services</b>	<b>0.498</b>	<b>0.180</b>	<b>–</b>
<b>Total fees</b>	<b>15.722</b>	<b>14.230</b>	<b>20.292</b>

All amounts were paid to EY or EY affiliated firms with fees determined, and predominantly billed, in US dollars.

#### Fees payable to the Group's auditors for assurance services

Audit of the Group's Annual Report comprises fees for auditing the statutory financial report of the Group and includes audit work in relation to compliance with section 404 of the US Sarbanes-Oxley Act.

Audit-related assurance services required by legislation to be provided by the auditors mainly comprises review of the half-year report.

Other assurance services comprise assurance in respect of the Group's sustainability reporting, economic contribution reporting, and other non-statutory reporting.

#### Fees payable to the Group's auditors for other services

Other services provided in FY2024 and FY2023 primarily relate to an independent assessment of technology project governance. No amounts were payable for other services in FY2022.

### 37 Not required for US reporting

### 38 Not required for US reporting

## 39 New and amended accounting standards and interpretations and changes to accounting policies

### New and amended accounting pronouncements adopted in the current year

#### Amendment to IAS 12/AASB112 'Income taxes' (IAS 12)

At 30 June 2023, the Group adopted amendments to IAS 12 issued by the IASB and AASB on 23 May 2023 and 27 June 2023, respectively, in relation to the Organisation for Economic Co-operation and Development (OECD)/G20 Inclusive Framework on Base Erosion and Profit Shifting (BEPS) Pillar Two income tax. The amendments introduced a temporary exception to the requirements of IAS 12 under which a company does not recognise or disclose information about deferred tax assets and liabilities related to the proposed Pillar Two model rules.

At 30 June 2024, having applied the temporary exception in the prior reporting period, the Group is required to disclose the potential impacts of Pillar Two income taxes.

Refer to note 6 'Income tax expense' for more information.

#### Amendment to IAS 1/AASB 101 'Presentation of Financial Statements' (IAS 1)

On 1 July 2023, the Group adopted amendments to IAS 1 that require entities to disclose their material accounting policy information rather than their significant accounting policies. The amendments did not significantly impact the Group's Financial Statements.

### New and amended accounting pronouncements on issue but not yet effective

#### IFRS 18/AASB 18 'Presentation and Disclosure in Financial Statements' (IFRS 18)

On 9 April 2024 and 14 June 2024, the IASB and AASB, respectively, issued IFRS 18 which will replace IAS 1 'Presentation of Financial Statements' for reporting periods beginning on or after 1 January 2027, with early application permitted.

IFRS 18 introduces new requirements on presentation within the statement of profit or loss, including specified totals and subtotals. It also requires disclosure of management-defined performance measures and includes new requirements for aggregation and disaggregation of financial information based on the identified roles of the primary financial statements and the notes. Further, the classification of interest and dividends within the statement of cash flows will change for some entities. Management is currently assessing the impact of IFRS 18 on presentation and disclosures in the Group's Financial Statements.

A number of other accounting standards and interpretations have been issued and will be applicable in future periods. While these remain subject to ongoing assessment, no significant impacts have been identified to date.

These pronouncements have not been applied in the preparation of these Financial Statements.

# 1A Reports of Independent Registered Public Accounting Firm

## Report of Independent Registered Public Accounting Firm

To the Shareholders and the Board of Directors of BHP Group Limited

### *Opinion on the Financial Statements*

We have audited the accompanying consolidated balance sheets of BHP Group Limited (the “Company”) as of 30 June 2024 and 2023, the related consolidated income statements, consolidated statements of comprehensive income, consolidated statements of changes in equity, and consolidated cash flow statements for each of the three years in the period ended 30 June 2024, and the related notes (collectively referred to as the “consolidated financial statements”). In our opinion, the consolidated financial statements present fairly, in all material respects, the financial position of the Company at 30 June 2024 and 2023, and the results of its operations and its cash flows for each of the three years in the period ended 30 June 2024, in conformity with International Financial Reporting Standards (“IFRS”) as issued by the International Accounting Standards Board.

We also have audited, in accordance with the standards of the Public Company Accounting Oversight Board (United States) (“PCAOB”), the Company’s internal control over financial reporting as of 30 June 2024, based on criteria established in Internal Control-Integrated Framework issued by the Committee of Sponsoring Organizations of the Treadway Commission (2013 framework) and our report dated 30 August 2024 expressed an unqualified opinion thereon.

### *Basis for Opinion*

These financial statements are the responsibility of the Company’s management. Our responsibility is to express an opinion on the Company’s financial statements based on our audits. We are a public accounting firm registered with the PCAOB and are required to be independent with respect to the Company in accordance with the U.S. federal securities laws and the applicable rules and regulations of the Securities and Exchange Commission and the PCAOB.

We conducted our audits in accordance with the standards of the PCAOB. Those standards require that we plan and perform the audit to obtain reasonable assurance about whether the financial statements are free of material misstatement, whether due to error or fraud. Our audits included performing procedures to assess the risks of material misstatement of the financial statements, whether due to error or fraud, and performing procedures that respond to those risks. Such procedures included examining, on a test basis, evidence regarding the amounts and disclosures in the financial statements. Our audits also included evaluating the accounting principles used and significant estimates made by management, as well as evaluating the overall presentation of the financial statements. We believe that our audits provide a reasonable basis for our opinion.

### *Critical Audit Matters*

The critical audit matters communicated below are matters arising from the current period audit of the financial statements that were communicated or required to be communicated to the Risk and Audit Committee and that: (1) relate to accounts or disclosures that are material to the financial statements and (2) involved our especially challenging, subjective or complex judgements. The communication of critical audit matters does not alter in any way our opinion on the consolidated financial statements, taken as a whole, and we are not, by communicating the critical audit matters below, providing separate opinions on the critical audit matters or on the accounts or disclosures to which they relate.

FOR BHP

### *Carrying value of property, plant and equipment*

#### Description of the Matter

As disclosed in Note 11 and Note 13 to the consolidated financial statements, the Company recorded US\$71,629 million in property, plant and equipment as of 30 June 2024 and recognised an impairment charge of US\$3,800 million related to the Western Australia Nickel cash generating unit (“CGU”). The Company performed impairment tests for all CGUs where there were indicators of impairment. Where such indicators existed, the Company estimated the recoverable amount to be the higher of a CGU’s value in use and its fair value less cost of disposal.

Auditing management’s assessment of indicators of impairment and impairment reversal and estimate of recoverable amount was complex due to the high degree of estimation uncertainty in forecasting the future cash flows for each CGU. Specifically, estimated future cash flows are sensitive to changes in significant assumptions, such as forecast commodity prices, production quantities, discount rates, carbon price assumptions and the cost of decarbonisation projects.

#### How We Addressed the Matter in Our Audit

We obtained an understanding, evaluated the design, and tested the operating effectiveness of the controls over the Company’s process to assess indicators of impairment or impairment reversal and to estimate the recoverable amount of the CGU for which an indicator of impairment was identified.

We performed an analysis for indicators of impairment and impairment reversal. Our procedures involved assessing the key inputs such as forecast commodity prices, production quantities, discount rates and the impact of climate change used in the assessment of indicators of impairment or impairment reversal.

We involved our valuation and climate change specialists to assist in assessing the reasonableness of commodity and carbon prices by comparing the forecasted commodity and carbon price assumptions to analyst and broker forecasts and those used by other market participants.

In addition, our valuation specialists assisted in testing the discount rates used, including a comparison to external market data and evaluating whether the valuation methodology used was consistent with industry practice.

To test the reserve quantities, we examined the information provided by the Company’s experts and we involved our mining reserve specialists to assist in the assessment of the reserve estimation methodology against the relevant industry and regulatory guidance.

With the assistance of our climate change specialists, we tested whether the Company’s forecast cash flows incorporated the costs of the Company’s decarbonisation plans.

We tested the mathematical accuracy of the models used and we assessed the competence, qualifications, and objectivity of management’s internal and external specialists.

In respect to the Western Australia Nickel CGU impairment, we performed testing of management’s estimate of the recoverable amount that included, among others, evaluating the significant assumptions used and compared the forecast cash flows against approved budgets and plans and evaluated the accuracy of prior year budgets against current year performance.

Finally, we assessed the adequacy of the disclosures within Notes 11, 13 and 16 of the consolidated financial statements.

For personal use only

### *Closure and rehabilitation provisions*

#### *Description of the Matter*

As disclosed in Note 15 to the consolidated financial statements, the Company recorded US\$9,837 million in closure and rehabilitation provisions as at 30 June 2024.

Provisions for closure and rehabilitation are recognised by the Company when there is a present legal or constructive obligation, it is probable that an outflow of resources will be required to settle the obligation, and the amount can be reliably estimated.

The Company estimates the individual site provisions using the expected value of future cash flows required to close and rehabilitate the relevant site using current restoration standards and techniques and taking into account risks and uncertainties. Individual site provisions are discounted to the present value using currency specific risk-free discount rates aligned to the estimated timing of cash outflows.

Auditing management's closure and rehabilitation provisions was complex and highly judgemental due to the significant estimation uncertainty within the key assumptions. Specifically, there was significant judgement in determining the expected life of sites including the impact of climate change, estimated cost and extent of rehabilitation activities, timing of activities, and the discount rates used. As a result of these inputs the provisions have a significant estimation uncertainty and a wide range of potential outcomes.

#### *How We Addressed the Matter in Our Audit*

We obtained an understanding, evaluated the design and tested the operating effectiveness of controls over the Company's closure and rehabilitation provision estimate process. Specifically, our procedures involved testing the controls around the significant estimates and assumptions, such as the costs associated with future closure activities, the extent and period of post-closure monitoring and maintenance, the impact of climate change, and the timing of cash flows and closure of operations.

Our procedures included evaluation of the completeness and accuracy of data used within management's estimate.

We tested that the future closure and rehabilitation costs were consistent with the closure plans prepared by management's internal specialists. We compared the expected life of sites and resulting timing of closure activities used in the provision to the life of asset plans prepared by management's internal specialists.

With the assistance of our rehabilitation specialists, we evaluated a sample of closure and rehabilitation provisions for operating and closed sites. Our testing included evaluating the closure and rehabilitation plans based on the relevant legal and regulatory requirements. In addition, we compared the timing of future cash flows and cost estimates against the closure and rehabilitation plan, environmental studies, and industrial practices.

We evaluated the discount rates used against market data.

With the assistance of both our climate change and rehabilitation specialists, we evaluated the Company's consideration of climate change, estimates related to post closure monitoring and maintenance and the timing of closure activities impacted by mine operating lives within the closure and rehabilitation provision.

We tested the mathematical accuracy of the closure and rehabilitation provision calculations and assessed the competence, qualifications, and objectivity of management's internal and external specialists. Finally, we assessed the adequacy of the disclosures within Notes 15 and 16 to the consolidated financial statements.

For personal use only

***Samarco dam failure provisions recognised and the contingent liabilities disclosed***

*Description of the Matter*

As described in Notes 3, 4, and 34 to the consolidated financial statements, the Company recorded a loss of US\$3,677 million (pre-tax) for the year ended 30 June 2024 and recognised provisions of US\$6,505 million for the Samarco dam failure as of 30 June 2024. The Company recognises a provision when it has a present obligation, and an outflow of economic resources is probable, and the obligation can be reliably measured. Contingent liabilities related to the Samarco dam failure are disclosed in Note 34.

Auditing management's estimate of the Samarco dam failure provisions and contingent liabilities disclosure was complex and highly judgemental due to the significant estimation uncertainty in determining the terms of any potential future outcome of the settlement negotiations and the measurement and completeness of future cash outflows, including the quantification of costs to resolve all aspects of the Federal Public Prosecution Office claim, being reparation, compensation and moral damages and the terms of the Framework Agreement. There was also significant judgement in determining the nature and extent of remediation activities, the cost estimates for remediation, the number and categorisation of impacted people entitled to compensation and the extent to which Samarco is able to directly fund any future obligations. As a result of these inputs the provision has a significant estimation uncertainty and a wide range of potential outcomes.

*How We Addressed the Matter in Our Audit*

We obtained an understanding, evaluated the design and tested the operating effectiveness of the Company's controls in determining the Samarco dam failure provisions and contingent liabilities and the relevant disclosures within the consolidated financial statements. Specifically, we tested management's controls over the significant assumptions as described above and the completeness and accuracy of data used within management's estimates.

To test the provisions, we performed audit procedures that included, amongst others, assessing methodologies and testing the significant assumptions discussed above and underlying data used by the Company in its analysis. We tested a sample of cost estimates used to source documents. We compared the nature and extent of activities included in the forecasted cash flows to the Federal Public Prosecution Office claim and the Framework Agreement. We tested the extent to which Samarco is able to directly fund any future obligations. We also tested the mathematical accuracy of the models used to calculate the provisions. To assess management's ability to forecast, we compared the prior years forecasted cash flows to actual results and understood key differences.

To assess the status of claims and contingent liability disclosures, we held discussions with the Company's internal legal counsel regarding ongoing Samarco dam failure litigation matters. In addition, we obtained legal confirmations and inspected communications with the Company's external legal counsel.

We evaluated the competence, qualifications and objectivity of the Company's experts who assisted management in estimating the provision by considering the scope of work, their professional qualifications and remuneration structure. We also assessed the adequacy and completeness of the disclosures within Notes 4 and 34 to the consolidated financial statements.

/s/ Ernst & Young

We have served as the Company's auditor since 2019.

Melbourne, Australia  
30 August 2024



## Report of Independent Registered Public Accounting Firm

To the Shareholders and the Board of Directors of BHP Group Limited

### *Opinion on Internal Control Over Financial Reporting*

We have audited BHP Group Limited's internal control over financial reporting as of 30 June 2024, based on criteria established in Internal Control – Integrated Framework issued by the Committee of Sponsoring Organizations of the Treadway Commission (2013 Framework) (the "COSO criteria"). In our opinion, BHP Group Limited (the "Company") maintained, in all material respects, effective internal control over financial reporting as of 30 June 2024, based on the COSO criteria.

We also have audited, in accordance with the standards of the Public Company Accounting Oversight Board (United States) ("PCAOB"), the consolidated balance sheets of the Company as of 30 June 2024 and 2023, the related consolidated income statements, consolidated statements of comprehensive income, consolidated statements of changes of equity, and consolidated cash flow statements for each of the three years in the period ended 30 June 2024, and the related notes (collectively referred to as the "consolidated financial statements") and our report dated 30 August 2024 expressed an unqualified opinion thereon.

### *Basis for Opinion*

The Company's management is responsible for maintaining effective internal control over financial reporting and for its assessment of the effectiveness of internal control over financial reporting included in the accompanying section 9.2 Corporate Governance Statement / Management's assessment of internal control over financial reporting. Our responsibility is to express an opinion on the Company's internal control over financial reporting based on our audit. We are a public accounting firm registered with the PCAOB and are required to be independent with respect to the Company in accordance with the U.S. federal securities laws and the applicable rules and regulations of the Securities and Exchange Commission and the PCAOB.

We conducted our audit in accordance with the standards of the PCAOB. Those standards require that we plan and perform the audit to obtain reasonable assurance about whether effective internal control over financial reporting was maintained in all material respects.

Our audit included obtaining an understanding of internal control over financial reporting, assessing the risk that a material weakness exists, testing and evaluating the design and operating effectiveness of internal control based on the assessed risk, and performing such other procedures as we considered necessary in the circumstances. We believe that our audit provides a reasonable basis for our opinion.

### *Definition and Limitations of Internal Control over Financial Reporting*

A company's internal control over financial reporting is a process designed to provide reasonable assurance regarding the reliability of financial reporting and the preparation of financial statements for external purposes in accordance with generally accepted accounting principles. A company's internal control over financial reporting includes those policies and procedures that (1) pertain to the maintenance of records that, in reasonable detail, accurately and fairly reflect the transactions and dispositions of the assets of the company; (2) provide reasonable assurance that transactions are recorded as necessary to permit preparation of financial statements in accordance with generally accepted accounting principles, and that receipts and expenditures of the company are being made only in accordance with authorisations of management and directors of the company; and (3) provide reasonable assurance regarding prevention or timely detection of unauthorised acquisition, use, or disposition of the company's assets that could have a material effect on the financial statements.

Because of its inherent limitations, internal control over financial reporting may not prevent or detect misstatements. Also, projections of any evaluation of effectiveness to future periods are subject to the risk that controls may become inadequate because of changes in conditions, or that the degree of compliance with the policies or procedures may deteriorate.

/s/ Ernst & Young

Melbourne, Australia  
30 August 2024

For personal use only

### 3 Directors' declaration

In accordance with a resolution of the Directors of BHP Group Limited, the Directors declare that:

- (a) in the Directors' opinion the Financial Statements and notes are in accordance with the Australian Corporations Act 2001 (Cth), including:
  - (i) complying with the applicable Accounting Standards and the Australian Corporations Regulations 2001 (Cth); and
  - (ii) giving a true and fair view of the assets, liabilities, financial position and profit or loss of BHP Group Limited and the Group as at 30 June 2024 and of their performance for the year ended 30 June 2024
- (b) [Intentionally omitted]
- (c) the Financial Statements comply with International Financial Reporting Standards, as disclosed in the Basis of preparation to the Financial Statements
- (d) to the best of the Directors' knowledge, the management report (comprising the Operating and Financial Review and Directors' Report) includes a fair review of the development and performance of the business and the position of BHP Group Limited and the undertakings included in the consolidation taken as a whole, together with a description of the principal risks and uncertainties that the Group faces
- (e) in the Directors' opinion there are reasonable grounds to believe that BHP Group Limited will be able to pay its debts as and when they become due and payable
- (f) as at the date of this declaration, there are reasonable grounds to believe that BHP Group Limited and each of the members of the Closed Group identified in Exhibit 8.1 - List of Subsidiaries will be able to meet any liabilities to which they are, or may become, subject because of the Deed of Cross Guarantee between BHP Group Limited and those group entities pursuant to ASIC Corporations (Wholly-owned Companies) Instrument 2016/785 and, in respect of OZ Minerals Pty Ltd, ASIC Instrument 24-0213
- (g) the Directors have been given the declarations required by Section 295A of the Australian Corporations Act 2001 (Cth) from the Chief Executive Officer and Chief Financial Officer for the financial year ended 30 June 2024

Signed in accordance with a resolution of the Board of Directors.

/s/ Ken MacKenzie

**Ken MacKenzie**

Chair

/s/ Mike Henry

**Mike Henry**

Chief Executive Officer

27 August 2024

**4 Not required for US reporting**

**5 Included as section 1A**

F-85

For personal use only

**Description of rights of each class of securities  
registered under Section 12 of the Securities Exchange Act of 1934 (the “Exchange Act”)**

American Depositary Shares (“ADSs”) representing two ordinary shares (the “shares”) of BHP Group Limited (“BHP”) are listed and traded on the New York Stock Exchange and, in connection with this listing (but not for trading), the shares are registered under Section 12(b) of the Exchange Act. This exhibit contains a description of the rights of (i) the holders of shares and (ii) ADS holders. Shares underlying the ADSs are held by Citibank N.A., as depositary, and holders of ADSs will not be treated as holders of the shares.

**Shares**

***Type and Class of Securities (Item 9.A.5 of Form 20-F)***

BHP’s shares are of no par value. The number of shares that have been issued as of the last day of the financial year ended June 30, 2024 is given in Note 17 ‘Share capital’ in the Financial Statements of the Form 20-F for the financial year ended June 30, 2024 (the “Form 20-F”). BHP’s shares are uncertificated registered shares, and may be transferred electronically through trading on the stock exchanges on which they are listed. Under BHP’s constitution, the Board of Directors has a power to refuse to register any transfer of securities where the registration would result in a contravention of (or failure to observe) any applicable law or the listing rules of ASX Limited (“ASX Listing Rules”), where BHP has a lien over the securities, where the securities are subject to forfeit, where the transfer would be in favor of more than four persons jointly, or where otherwise permitted under the ASX Listing Rules.

***Preemptive Rights (Item 9.A.3 of Form 20-F)***

Not applicable.

***Limitations or Qualifications (Item 9.A.6 of Form 20-F)***

A description of how the constitution of BHP limits or qualifies the rights of the shares is provided in sections “Additional information – 9.4 Constitution – Rights attaching to shares” and “Additional information – 9.4 Constitution – Redemption of preference shares” of the Form 20-F.

***Other Rights (Item 9.A.7 of Form 20-F)***

Not applicable.

***Rights of the Shares (Item 10.B.3 of Form 20-F)***

See sections “Additional information – 9.4 Constitution”, “Additional information – 9.5 Share ownership” and “Additional information – 9.6 Dividends” of the Form 20-F.

***Requirements for Amendments (Item 10.B.4 of Form 20-F)***

See section “Additional information – 9.4 Constitution – Variation of class rights” of the Form 20-F.

***Limitations on the Rights to Own Shares (Item 10.B.6 of Form 20-F)***

See sections “Additional information – 9.4 Constitution – Limitations of rights to own securities” and “Additional information – 9.8 Governmental regulations – Shareholding limits” of the Form 20-F.

***Provisions Affecting Any Change of Control (Item 10.B.7 of Form 20-F)***

Not applicable.

***Ownership Threshold (Item 10.B.8 of Form 20-F)***

There are no provisions in BHP’s constitution governing the ownership threshold above which shareholder ownership must be disclosed. Shareholders will, however, be required to disclose shareholder ownership in accordance with the Australian Corporations Act 2001 (Cth), the Australian Corporations Regulations 2001 (Cth), and the Disclosure Guidance and Transparency Rules of the UK Financial Conduct Authority.

***Differences Between the Law of Different Jurisdictions (Item 10.B.9 of Form 20-F)***

See “Rights of the Shares” and “Limitations on the Rights to Own Shares” above.

***Changes in Capital (Item 10.B.10 of Form 20-F)***

Not applicable.

***American Depositary Shares (Items 12.D.1 and 12.D.2 of Form 20-F)***

Citibank, N.A., as depositary, will issue the ADSs representing shares. Citibank, N.A., has been appointed as the depositary pursuant to the deposit agreement among the depositary, the holders the ADSs thereunder, and BHP (as amended, the “deposit agreement”). Each ADS represents two shares. The depositary’s principal office at which the ADSs will be administered is located at 388 Greenwich Street, New York, New York 10036.

You may hold ADSs either directly or indirectly through your broker or other financial institution. If you hold ADSs directly, by having ADSs registered in your name on the books of the depositary, you are an ADS holder. This description assumes you hold your ADSs directly. If you hold the ADSs indirectly, you must rely on the procedures of your broker or other financial institution to assert the rights of ADS holders described in this section. You should consult with your broker or financial institution to find out what those procedures are. Your ADSs may be issued on the books of the depositary in book-entry form, in which case your ADSs will be held through the depositary’s direct registration system reflecting your ownership of these ADSs, or your ADSs may be evidenced by one or more American Depositary Receipts (“ADRs”).

As an ADS holder, BHP will not treat you as one of its shareholders and you will not have shareholder rights. The depositary or its nominee will be the holder of record of the shares underlying your ADSs. As a holder of ADSs, you will have ADS holder rights. The deposit agreement entered into among BHP, the depositary, you, as an ADS holder, and the other holders and beneficial owners of ADSs sets out ADS holder rights as well as the rights and obligations of the depositary. New York law governs the deposit agreement and the ADRs. Because the depositary or its nominee will actually be the record owner of the shares, you must rely on it to exercise the rights of a shareholder on your behalf.

The following is a summary of the material provisions of the deposit agreement. For more complete information, you should read the deposit agreement and form of ADR. The deposit agreement has been filed with the SEC as an exhibit to a Registration Statement on Form F-6 (File No. 333-259259) on September 2, 2021 and as amended on July 29, 2022. The form of ADR has been filed with the SEC on July 29, 2022 as an exhibit to that Registration Statement.

***Voting Rights***

*How do you vote?*

You may instruct the depositary to vote the shares underlying your ADSs, but only if BHP requests the depositary to ask for your instructions. Otherwise, you will be unable to exercise your right to vote unless you withdraw the shares. However, you may not have sufficient advance notice of the meeting in order to withdraw the shares in time to exercise your right to vote.

If BHP requires the depositary to ask for your instructions, the depositary will notify you of the upcoming vote and, upon receipt of voting materials from BHP, will arrange to deliver BHP voting materials to you. The materials will (1) describe the matters to be voted on and (2) explain how you may instruct the depositary to vote the shares or other deposited securities underlying your ADSs as you direct. For instructions to be valid, the depositary must receive them on or before the date specified in the voting materials. The depositary has agreed that it will try to vote or to have its agents vote the shares or other deposited securities as you instruct, insofar as it is practicable and permitted under applicable law, the deposit agreement, the provisions of the deposited securities and BHP’s constitution. The depositary will only vote or attempt to vote as you instruct.

If no voting instructions are received by the depositary from you with respect to any of the deposited securities represented by the ADSs on or before the date established by the depositary for submission of such instructions, the depositary will not vote such deposited securities. Voting instructions received from ADS holders will be aggregated and the depositary will try to vote or cause to be voted the deposited securities in accordance with these voting instructions.

BHP cannot assure you that you will receive the voting materials in time to ensure that you can instruct the depositary to vote the shares underlying your ADSs. In addition, the depositary and its agents are not responsible for failing to carry out voting instructions or for the manner of carrying out voting instructions, provided that such nonaction or action is in good faith. This means that you may not be able to exercise your right to vote and there may be nothing you can do if the shares underlying your ADSs are not voted as you requested.

### ***Dividends and Other Distributions***

*How will you receive dividends and other distributions on the shares?*

The depositary has agreed to pay to you the cash dividends or other distributions it or the custodian receives on shares or other deposited securities, after converting any cash received into U.S. dollars, and, in all cases, deducting its fees and expenses and any taxes required to be withheld. You will receive these distributions in proportion to the number of shares your ADSs represent.

*Cash.* The depositary will convert any cash dividend or other cash distribution BHP pays on the shares into U.S. dollars, if it can do so on a reasonable basis and can transfer the U.S. dollars to the United States. If that is not possible or if any government approval is needed and cannot be obtained, the deposit agreement allows the depositary to distribute the foreign currency only to those ADS holders to whom it is possible to do so. It will hold the foreign currency it cannot convert for the account of the ADS holders who have not been paid. It will not invest the foreign currency and it will not be liable for any interest.

Before making a distribution, any withholding taxes that must be paid will be deducted. In addition, before any distribution, the fees and expenses of the depositary will be deducted. It will distribute only whole U.S. dollars and cents. If the exchange rates fluctuate during a time when the depositary cannot convert the foreign currency, you may lose some or all of the value of the distribution.

*Shares.* The depositary may distribute additional ADSs representing any shares BHP distributes as a dividend or free distribution of shares. The depositary will only distribute whole ADSs. In lieu of delivering fractional ADSs, the depositary will sell shares or ADSs by public or private sale and distribute the net proceeds in the same way as it does with cash. If the depositary does not distribute additional ADSs, the outstanding ADSs will also represent the new shares.

*Rights to purchase additional shares.* If BHP offers holders of its securities any rights to subscribe for additional shares, the depositary will make these rights available to you if (i) BHP has timely requested such rights be made available to you, (ii) BHP shall have delivered to the depositary satisfactory documentation in accordance with the deposit agreement and (iii) the depositary shall have determined such distribution is reasonably practicable. If the depositary decides it is not reasonably practicable to make the rights available, BHP does not meet the requirements of (i) or (ii) above, or any rights are not exercised and appear to be about to lapse, but that it is legal and practical to sell the rights, the depositary will sell the rights and distribute the proceeds in the same way as it does with cash. The depositary will allow rights that are not distributed or sold to lapse. In that case, you will receive no value for them.

*Other distributions.* The depositary will distribute to you any property distributed on deposited securities, other than cash, shares and rights, provided that (i) BHP has timely requested such distribution be made available to you, (ii) BHP shall have delivered satisfactory documentation in accordance with the deposit agreement and (iii) the depositary shall have determined such distribution to be reasonably practicable. The depositary will make any such distribution in such manner it deems practicable. If it cannot make the distribution BHP determines to be distributed to you, it will sell such property in whatever means it deems practicable and distribute the net proceeds, in the same way as it does with cash.

Neither BHP nor the depositary is responsible if it decides that it is unlawful or impracticable to make a distribution available to any ADS holders. BHP has no obligation to register ADSs, shares, rights or other securities under the Securities Act. BHP also has no obligation to take any other action to permit the distribution of ADSs, ADRs, shares, rights or anything else to ADS holders. This means that you may not receive the distributions BHP makes on the shares or any value for them if it is illegal or impractical for BHP to make them available to you. There can be no assurance that the depositary will be able to convert any currency at a specified exchange rate or sell any property, rights or shares or the securities at a specified price, nor that any such transaction can be completed in a specified time.

#### ***Notices and Reports***

The depositary will make available for ADS holders' inspection at its principal office any notices, reports and communications, including any proxy soliciting material, that it receives from BHP, if those notices, reports and communications are both (a) received by the depositary as the holder of the deposited securities and (b) made generally available by BHP to the holders of the deposited securities. The depositary will also make available to ADS holders copies of such reports when furnished by BHP pursuant to the deposit agreement. In addition, BHP is subject to the periodic reporting requirements of the Exchange Act and, accordingly, file certain reports with the SEC. Such reports and documents can be retrieved from the SEC's website ([www.sec.gov](http://www.sec.gov)).

#### ***Reclassifications, Recapitalizations and Mergers***

If BHP takes certain actions that affect the deposited securities, including (i) any change in par value, split up, cancellation, consolidation or other reclassification of deposited securities or (ii) any recapitalization, reorganization, merger, consolidation or sale of assets affecting BHP or to which it is a party, then the depositary may choose to:

- issue and deliver additional ADSs as in the case of a share dividend;
- amend the deposit agreement and the ADRs;
- amend the applicable Registration Statement on Form F-6 filed with the SEC in respect of the ADSs;
- call for the surrender of outstanding ADRs to be exchanged for new ADRs; and
- take any other actions as are reasonably requested by BHP or as the depositary, in consultation with BHP, considers appropriate to reflect the transaction.

#### ***Amendment and Termination***

##### *How may the deposit agreement be amended?*

BHP may agree with the depositary to amend the deposit agreement and the form of the ADRs without your consent if BHP and the depositary deem it necessary or desirable. If an amendment adds or increases fees or charges (other than charges in connection with foreign exchange control regulations, and taxes and other governmental charges, delivery and other such expenses), or materially prejudices a substantial right of ADS holders, it will not become effective for outstanding ADRs until 30 days after the ADS holders have been given notice of the amendment. At the time an amendment becomes effective, you are considered, by continuing to hold your ADSs, to agree to the amendment and to be bound by the form of the ADRs and the deposit agreement as amended.

##### *How may the deposit agreement be terminated?*

The depositary will terminate the deposit agreement at BHP's direction by distributing notice of termination to the ADS holders then outstanding at least 90 days prior to the date fixed in such notice for such termination. If, at any time, 90 days shall have expired after the depositary shall have delivered to BHP a written notice of its election to resign or BHP has delivered to the depositary written notice of BHP's election to remove the depositary, and a successor depositary shall not have been appointed and have accepted its appointment, the depositary may also terminate the deposit agreement by providing notice of termination at least 90 days prior to the date of termination to BHP and the holders of ADSs then outstanding.



After termination, the depositary and its agents will do the following under the deposit agreement but nothing else: collect dividends and distributions on the deposited securities, sell rights and other property received in respect of deposited securities, deliver shares and other deposited securities upon cancellation of ADSs and take such actions as may be required under applicable law in connection with its role as depositary. At any time after termination, the depositary may sell any remaining deposited securities by public or private sale. After that, the depositary will hold the money it received from the sale, as well as any other cash it is holding under the deposit agreement for the pro rata benefit of the ADS holders that have not surrendered their ADSs. The depositary will not invest the money and has no liability for interest. The depositary's only obligations will be to account for the money and other cash, and other obligations as may be required under applicable law in connection with the termination of the deposit agreement. After termination, BHP's only obligations will be to indemnify the depositary and to pay fees and expenses of the depositary that BHP agreed to pay.

### ***Inspection of Transfer Books***

The depositary will keep books at its principal office for the registration and transfer of ADSs, which will be open for your inspection at all reasonable times. However, such inspection shall not be for the purpose of communicating with other owners of ADSs in the interest of a business or object other than BHP's business or other than a matter related to the deposit agreement or the ADSs.

### ***Deposit, Withdrawal and Cancellation***

#### *How are ADSs issued?*

The depositary will issue ADSs if you or your broker deposit shares or evidence of rights to receive shares with the custodian and pay fees and expenses and any taxes or charges, such as share transfer registration fees owing to the depositary under the deposit agreement. Shares deposited with the custodian must be accompanied by certain delivery documentation, including documentation showing confirmation of the book-entry transfer and recordation of the shares to the custodian or that such irrevocable instructions have been given and any necessary governmental approvals have been obtained. Upon each deposit of shares, receipt of related delivery documentation and compliance with the other provisions of the deposit agreement, including the payment of the fees and charges of the depositary and any taxes or other fees or charges owing, the depositary will issue ADSs in the name or upon the order of the person entitled thereto.

All of the ADSs issued will be part of the depositary's direct registration system, and a registered holder will receive periodic statements from the depositary which will show the number of ADSs registered in such holder's name. An ADS holder can request that the ADSs not be held through the depositary's direct registration system and that an ADR be issued. The custodian will not accept a deposit of fractional shares or a number of shares which would give rise to fractional ADSs.

The custodian will hold all deposited shares for the account of the depositary. ADS holders thus have no direct ownership interest in the shares and only have such rights as are contained in the deposit agreement. The custodian will also hold any additional securities, property and cash received on or in substitution for the deposited shares. The deposited shares and any such additional items are referred to as "deposited securities".

#### *How do ADS holders cancel an ADS and obtain shares?*

You may turn in your ADRs at the depositary's principal office or, in the case of direct registration ADS, provide proper instructions and documentation for cancellation of ADSs. Upon payment of its fees and expenses and of any taxes or charges, such as share transfer registration fees, the depositary will deliver the shares represented by the corresponding amount of ADSs or ADRs and any other deposited securities underlying the ADSs or ADRs to you or a person you designate in accordance with your order. Any dividends or other cash held in respect of the deposited securities so delivered shall be delivered to you at the office of the custodian, or, at your request, risk and expense, the depositary will direct the custodian to forward (to the extent permitted by law) any cash or other property (other than securities) for delivery at its principal office.

The depositary shall not accept for surrender ADSs representing less than one share. In the case of delivery to it of ADSs representing a number other than a whole number of shares, the depositary shall cause ownership of the appropriate whole number of shares to be delivered in accordance with the deposit agreement, and shall, at the discretion of the depositary, either (i) return to the person surrendering such ADSs the number of ADSs representing any remaining fractional share, or (ii) sell or cause to be sold the fractional share represented by the ADSs so surrendered and remit the proceeds of such sale (net of (a) applicable fees and charges of, and expenses incurred by, the depositary and (b) taxes withheld) to the person surrendering the ADSs.

#### ***Requirements for Depositary Actions***

Before the depositary will take certain actions, including deliver or register a transfer of an ADS, make a distribution on an ADS, or permit withdrawal of shares, the depositary may require:

- payment for any tax or other governmental charges and share transfer or registration fee with respect thereto and payment of any applicable fees and charges of the depositary;
- satisfactory proof of the identity and genuineness of any signature or any other matters contemplated by the deposit agreement; and
- compliance with any laws or governmental regulations, or such reasonable regulations that the depositary and BHP may establish consistent with the deposit agreement.

The depositary may refuse to deliver ADSs or register transfers of ADSs generally when the transfer books of the depositary or BHP's transfer books are closed or if any such action is deemed necessary or advisable by the depositary or BHP, in good faith, at any time or from time to time because of any requirement of law or regulation, any government or governmental body or commission or any securities exchange on which shares or ADSs are listed, or under any provision of the deposit agreement or ADRs, if applicable, or under any provision of, or governing, the deposited securities, or because of a meeting of BHP's shareholders or for any other reason, subject, in all cases to compliance with U.S. securities laws.

#### ***Your Right to Receive the Shares Underlying Your ADSs***

You have the right to cancel your ADSs and withdraw the underlying shares at any time except:

- when temporary delays arise because: (i) the depositary has closed its transfer books or BHP has closed its transfer books; (ii) the transfer of shares is blocked to permit voting at a shareholders' meeting; or (iii) BHP is paying a dividend on its shares;
- when you or other ADS holders seeking to withdraw shares owe money to pay fees, taxes and similar charges; or
- when it is necessary to prohibit withdrawals in order to comply with any laws or governmental regulations that apply to ADSs or to the withdrawal of shares or other deposited securities.

#### ***Limitations on Obligations and Liability***

The deposit agreement expressly limits BHP's obligations and the obligations of the depositary. It also limits BHP's liability and the liability of the depositary. BHP and the depositary:

- are not liable if either of them is prevented or delayed by law, regulation, any other governmental authority or regulatory authority or stock exchange, BHP's constitution, any provision of or governing any deposit securities or any act of god or war or other circumstances beyond BHP's control from performing BHP's obligations under the deposit agreement;

- are not liable if either of them exercises or fails to exercise discretion permitted under the deposit agreement, the provisions of or governing the deposited securities or BHP's constitution;
- are not liable for any action or inaction in reliance upon the advice of or information from legal counsel, any person presenting shares for deposit, any holder, any beneficial owner or authorized representative thereof, or accountants, or any other person believed by it in good faith to be competent to give such advice;
- are not liable for the inability of any ADS holder to benefit from any distribution, offering, right or other benefit which is made available to holders of deposited securities but is not under the terms of the deposit agreement made available to holders of ADSs;
- are not liable for consequential or punitive damages for any breach of the terms of the deposit agreement;
- are only obligated to take the actions specifically set forth in the deposit agreement or the ADRs; and
- have no obligation to become involved in a lawsuit or other proceeding related to the deposited securities, the ADSs or the deposit agreement on your behalf or on behalf of any other party.

BHP and the depositary are protected in acting in reliance upon any written notice, request or other document believed by it to be genuine and to have been signed or presented by the proper party or parties.

Neither BHP nor the depositary will be liable for any failure to carry out any instructions to vote any of the deposited securities, or for the manner in which any vote is cast or the effect of any vote, provided that any such action or omission is in good faith and in accordance with the terms of the deposit agreement or incur any liability for any failure to determine that any distribution or action may be lawful or reasonably practicable, for any investment risk associated with acquiring an interest in the deposited securities, for the validity or worth of the deposited securities or for any tax consequences that may result from the ownership of ADSs, shares or deposited securities, or for the credit worthiness of any third party. The depositary will not be liable for the content of any information submitted to it by BHP for distribution to the holders or for any inaccuracy of any translation thereof, for allowing any rights to lapse upon the terms of the deposit agreement or for the failure or timeliness of any notice of BHP.

In the deposit agreement, BHP and the depositary agree to indemnify each other under certain circumstances.

## Summary of terms of employment for Mike Henry – Chief Executive Officer, BHP

### 1. Term

Mr Henry is employed under a single employment agreement with the BHP Group with no fixed term. The contract is applicable with effect from the date of Mr Henry's appointment as Chief Executive Officer (CEO) on 1 January 2020. Mr Henry's performance and remuneration will be reviewed at the end of each financial year.

The Group retains the right to terminate the contract by giving 12 months' notice or by making payment in lieu of notice of 12 months' base salary plus the relevant contribution to a superannuation or pension scheme. Mr Henry is also entitled to any accrued entitlements such as earned but untaken leave. Mr Henry has a right to terminate the contract by giving 12 months' notice.

### 2. Fixed Salary and Retirement Benefits

Mr Henry is paid a base salary which is reviewed annually, and any increase to his base salary is disclosed annually in the Remuneration Report (which is a section in BHP's fiscal year Annual Report). Effective 1 September 2024, Mr. Henry's base salary is US\$1,893,000 per annum. He is entitled to an additional sum equal to 10 per cent of base salary which he may pay into a superannuation or pension scheme, defer receipt of until retirement under the retirement savings plan, or take as a cash payment in lieu of retirement benefits.

Where Mr Henry elects to allocate the retirement contribution to a superannuation or pension scheme, or the retirement savings plan, the rules of the relevant plans will apply.

### 3. Benefits

Mr Henry receives additional benefits including the cost of private health, life and disability insurance, car parking, fringe benefits tax and the preparation of multi-jurisdictional taxation returns.

### 4. Incentive arrangements

Mr Henry is eligible to participate in incentive arrangements offered by BHP from time to time. Initially, Mr Henry will participate in the Cash and Deferred Plan (CDP) and the Long Term Incentive Plan (LTIP). The CDP and LTIP are part of BHP's remuneration policy which was approved by shareholders at the 2019 Annual General Meetings.

#### *CDP*

Under the rules of the CDP, Mr Henry is entitled to incentive awards calculated by reference to his base salary. For performance at the target level, which requires Mr Henry to meet the rigorous performance hurdles set by the Board, including delivery of the budget, Mr Henry would receive a cash bonus worth 80 per cent of base salary. For performance at the maximum level, Mr Henry would receive a cash bonus of 120 per cent of base salary. Two tranches of deferred shares will be awarded to Mr Henry, each to the equivalent value of the actual cash bonus received. These two tranches of deferred shares will vest in two years and five years, respectively.

The grant of deferred shares will be subject to the approval of shareholders where required by applicable listing rules.

#### *LTIP*

Long-term incentives are issued under the terms of the LTIP. The number of LTIP awards allocated will be, on a face value basis, a maximum of 200 per cent of Mr Henry's base salary, and based on the 12-month average share price and exchange rate up to and including the 30 June preceding the date of grant. LTIP awards are subject to performance hurdles, which are measured five years after the effective date of the grant. Performance hurdles are not subject to re-testing.

The performance hurdle requires BHP's total shareholder return (TSR) over a five-year performance period to be measured against the TSR of a sector peer group (67 per cent of awards) and the TSR of a global company index (33 per cent of awards). No LTIP awards vest if BHP's TSR is below the relevant comparator group TSR and the LTIP awards will be forfeited. 25 per cent of LTIP awards vest if BHP's TSR is at the relevant comparator group TSR. For all LTIP awards to vest, BHP's TSR must be at or above the 80th percentile TSR of the relevant comparator group. For performance between the relevant comparator group TSR and the 80th percentile TSR of the relevant comparator group, vesting occurs on a sliding scale.

The grant of LTIP awards will be subject to the approval of shareholders where required by applicable listing rules.

#### ***Dividends***

A dividend equivalent payment (DEP) is provided on vested CDP deferred shares and vested LTIP awards. No payment is made in respect of unvested or lapsed CDP deferred shares and LTIP awards. DEPs are paid in the form of shares.

#### ***Entitlements on termination***

The rules of the CDP and LTIP and BHP's remuneration policy provide that where employment is terminated by the resignation of the executive, or by the Group for cause, Mr Henry is not entitled to any cash incentive for the year in question and all CDP deferred shares or LTIP awards will lapse.

If Mr Henry retires or his employment terminates by mutual agreement:

- he may, at the People and Remuneration Committee's discretion, be considered for a prorata incentive under the CDP for the period of service during that year based on performance;
- CDP two-year deferred shares would vest in full on the original vesting date;
- CDP five-year deferred shares would vest on the original vesting date, with the number of deferred shares to vest reduced prorata to reflect the period of service; and
- he would have a right to retain entitlements to LTIP awards, which would vest on the original vesting date, only if, and to the extent, the performance hurdles are ultimately met. The number of entitlements Mr Henry would be permitted to retain would be reduced prorata to reflect the period of service.

Special provisions relate to events described as "uncontrollable" such as death and serious injury. In those circumstances, all of the CDP deferred shares and LTIP awards that have been awarded but which have not vested or are not exercisable vest immediately to and/or become immediately exercisable by Mr Henry or his estate.

#### **5. Minimum shareholding requirement (MSR)**

The Board and People and Remuneration Committee has determined that during his term as CEO, Mr Henry will be required to hold BHP securities with a value at least equal to five times one year's pre-tax (gross) base salary, and this applies for two years post-retirement. The value of the securities for the purposes of this requirement is the market value of the underlying shares. Unvested awards do not qualify.

The CEO is expected to grow his holdings to the MSR from the scheduled vesting of his employee awards over time. The MSR is tested at the time that shares are to be sold. Shares may be sold to satisfy tax obligations arising from the granting, holding, vesting, exercise or sale of the employee awards or the underlying shares whether the MSR is satisfied at that time or not.

**6. Leave entitlements**

Mr Henry will be entitled to the following leave entitlements:

- Annual leave – in accordance with applicable Australian law, currently four weeks per annum.
- Other leave – in accordance with applicable law.

**7. Post-employment restraints**

Mr Henry will be subject to non-competition and non-solicitation restraints that operate for 12 months after the cessation of his employment.

For personal use only

**Equity and Cash Incentive Plan Rules**  
**BHP Group Limited**  
ACN 004 028 077  
Adopted on 25 September 2023

---

For personal use only

## Table of Contents

<b>INTRODUCTION</b>	<b>1</b>
<b>1 Offers of incentives</b>	<b>1</b>
1.1 Board to make invitations	1
1.2 Information to be provided to Participants	2
1.3 Acceptance of Offer	2
1.4 Offer terms and conditions take precedence	2
<b>2 Rights</b>	<b>3</b>
2.1 Grant	3
2.2 Vesting	3
2.3 Allocation	4
2.4 Payment of cash equivalent	4
2.5 Lapse of Rights	5
<b>3 Options</b>	<b>5</b>
3.1 Grant	5
3.2 Vesting	5
3.3 Allocation following exercise	6
3.4 Payment of cash equivalent	6
3.5 Lapse of Options	7
<b>4 Restricted Shares</b>	<b>7</b>
4.1 Allocation	7
4.2 Restricted Shares purchased by salary sacrifice	7
4.3 Restricted Shares that are tax-exempt	8
4.4 Cessation of restrictions	8
4.5 Forfeiture of Restricted Shares	9
<b>5 Units</b>	<b>9</b>
5.1 Grant	9
5.2 Vesting	9
5.3 Payment of cash amount	10
5.4 Lapse of Units	10
<b>6 Cash Amounts</b>	<b>10</b>
6.1 Offer, Performance and Award	10
6.2 Payment of Cash Amounts	10
6.3 Board Discretion in relation to Cash Amounts	11
6.4 Entitlement to Cash Amounts	11
<b>7 Prohibited Dealings</b>	<b>11</b>
<b>8 Vesting outcomes</b>	<b>12</b>
<b>9 Preventing inappropriate benefits</b>	<b>12</b>
9.1 When the Board can take action	12
9.2 Actions the Board can take	13
9.3 Investigations	14
9.4 BHP Malus and Clawback Policy	14
9.5 Board's overriding discretion	14
<b>10 Forfeiture of Shares</b>	<b>14</b>
<b>11 Cessation of employment</b>	<b>15</b>
11.1 Board discretion on cessation	15
11.2 Post cessation discretions	15
11.3 Approved leave of absence	16



<b>12</b>	<b>Change of Control</b>	<b>16</b>
12.1	Change of Control Events	16
12.2	Notification of Vesting	17
12.3	Treatment of Vested Incentive Securities	17
12.4	Acquisition of shares in Acquiring Company	17
12.5	Divestment of material business or subsidiary	17
<b>13</b>	<b>Power to adjust Rights, Options and/or Units and the Exercise Price</b>	<b>18</b>
<b>14</b>	<b>Dividends and other rights</b>	<b>19</b>
14.1	Dividends and other rights associated with Shares	19
14.2	Dividend equivalent payments and other rights	19
<b>15</b>	<b>Custody Arrangements</b>	<b>20</b>
<b>16</b>	<b>Withholding</b>	<b>20</b>
<b>17</b>	<b>Amendments</b>	<b>21</b>
17.1	Power to make amendments	21
17.2	Restrictions on amendments	21
17.3	Notice of amendment	22
<b>18</b>	<b>Participants based overseas</b>	<b>22</b>
18.1	Overseas transfers	22
18.2	Non-Australian residents	22
18.3	Non-Australian taxpayers	22
<b>19</b>	<b>Misleading statements and omissions where monetary consideration is provided by Participants</b>	<b>22</b>
19.1	Additional disclosure	22
19.2	Misleading Statements and Omissions	23
19.3	Liability	23
19.4	Limitation of Liability	23
<b>20</b>	<b>Miscellaneous</b>	<b>24</b>
20.1	Shares issued under these Rules	24
20.2	Rights and obligations of Participants	24
20.3	Power of the Board to administer these Rules	25
20.4	Overriding Board discretion	25
20.5	Waiver of terms and conditions	25
20.6	Application of constitution of the Company, Corporations Act, Listing Rules and other applicable laws	26
20.7	Error in Allocation	26
20.8	Exchange Rate	26
20.9	Dispute or disagreement	26
20.10	Communication	26
20.11	Data protection	27
20.12	Tax	28
20.13	Laws governing these Rules	28
<b>21</b>	<b>Definition and Interpretation</b>	<b>29</b>
21.1	Definitions	29
21.2	Interpretation	33
	<b>Addendum 1</b>	<b>34</b>
	<b>Addendum 2</b>	<b>36</b>

---

**BHP Equity and Cash Incentive Plan Rules**  
**INTRODUCTION**

---

The purpose of these Rules is to allow the Board to make Offers of Incentive Securities and cash bonuses to Eligible Employees.

These Rules outline the terms and conditions upon which Offers will be made, including:

- the process for making and accepting Offers (**PART A**);
- the type of incentives that may be offered (being Rights, Options, Restricted Shares, Units and Cash Amounts) (**PART B**); and
- the general terms and conditions that apply to incentives (**PART C**).

Capitalised terms are defined in **PART D** of these Rules.

**Addendum 1** and **Addendum 2** to these Rules contain certain rules and definitions that apply to any Participant who is subject to foreign laws. The terms and conditions set out in the Addenda apply to such Participants and, as indicated in the Addenda, certain terms and conditions of these Rules will not apply to such Participants. In the case of any conflict between the terms of these Rules and the terms of an applicable Addendum, the terms of the applicable Addendum will prevail.

---

**PART A**

---

**1 Offers of incentives**

---

**1.1 Board to make invitations**

- (a) The Board may, from time to time, in its absolute discretion invite Eligible Employees to participate in a grant of Incentive Securities and/or an award of cash incentives, which may comprise any one or more of:
- Rights;
  - Options;
  - Restricted Shares;
  - Units; and
  - Cash Amounts,
- (Offer).**
- (b) Offers will be made on the terms set out in these Rules and/or on any additional or alternative terms as the Board determines, as specified in the terms of an Offer.
- (c) Offers of Incentive Securities made under these Rules in Australia are made under Division 1A of Part 7.12 of the Corporations Act.

## 1.2 Information to be provided to Participants

Without limiting the Board's discretion, the terms of the Offer to an Eligible Employee may include the following information:

- (a) the maximum Cash Amount being offered or method by which the amount will be calculated;
- (b) the type and number of Incentive Securities being offered, or the method by which the number or amount will be calculated;
- (c) the amount (if any) that will be payable for the grant of Incentive Securities;
- (d) any Vesting Conditions or other conditions that apply, including any Vesting Period;
- (e) information relating to the exercise of an Option or a Right (where exercisable), including any exercise price payable and any relevant exercise period(s);
- (f) where the Board has made a determination pursuant to rules 2.2(e) or 3.2(e) at the time of the Offer, clarification as to whether Rights or Options will be settled through an allocation of Shares or by making a cash payment (as applicable);
- (g) the circumstances in which Incentive Securities may lapse, Incentive Securities or Cash Amounts may be forfeited or a Participant's entitlement to Incentive Securities or Cash Amounts may be reduced;
- (h) how Incentive Securities or Cash Amounts may be treated if the Eligible Employee ceases employment with a Group company and any discretions retained by the Board under rule 11;
- (i) any restrictions (including the period of restriction) on Dealing in relation to a Restricted Share or Share allocated to the Eligible Employee under these Rules; and
- (j) where all or part of an Offer is made as a salary sacrifice offer under rule 4.2 or as a tax-exempt offer under rule 4.3 of these Rules, the Offer should specify this.

## 1.3 Acceptance of Offer

- (a) Acceptance of an Offer must be made by the Eligible Employee in accordance with the instructions that accompany the Offer, or in any other way the Board determines.
- (b) The Board may, at its discretion, refuse to allow the participation of an Eligible Employee where that Eligible Employee ceases to be an Eligible Employee, or ceases to satisfy any other conditions imposed by the Board, before the grant is made.
- (c) Nothing limits the Board's ability to treat the conduct of an Eligible Employee in respect of an Offer (including the failure of an Eligible Employee to lodge an election not to participate within the time specified in the instructions accompanying the Offer) as valid acceptance of that Offer under these Rules.
- (d) The Board may revoke an Offer given to an Eligible Employee prior to the date specified for the acceptance of the Offer or the grant of Incentive Securities being made or the Cash Amount being paid, whichever is later, and such Offer will be deemed never to have been made.

## 1.4 Offer terms and conditions take precedence

To the extent of any inconsistency, the terms and conditions advised to an Eligible Employee in an Offer will prevail over any other provision of these Rules.

---

**2 Rights**

---

**2.1 Grant**

- (a) Where an Eligible Employee has accepted an Offer to participate in a grant of Rights in accordance with rule 1.3(a), the Board will, subject to its discretion under rule 1.3(b), grant Rights to the Eligible Employee.
- (b) Unless the Board determines otherwise or otherwise specified in an Offer:
  - (1) no payment is required for the grant of a Right;
  - (2) Rights may not be registered in any name other than that of the Eligible Employee; and
  - (3) where the Offer is made to an Eligible Employee in Australia, subdivision 83A-C of the Tax Act applies to the Rights (subject to the requirements of the Tax Act).

**2.2 Vesting**

- (a) Subject to any express rule to the contrary, a Right will only Vest (and if applicable, become exercisable) where each Vesting Condition, and all other relevant conditions advised to the Participant by the Board pursuant to rule 1.2, have been satisfied or otherwise waived by the Board.
- (b) Vesting occurs upon notification from the Company (or its delegate) to the Participant that a Right has Vested pursuant to this rule 2.2.
- (c) Where the Board notifies a Participant that a Right is exercisable, the exercise of the Right will be effected in the form and manner determined by the Board and notified to the Participant. If an exercisable Right is not exercised (or otherwise surrendered by the Participant) by the end of the exercise period or expiry date specified in the terms of an Offer, the Right will be automatically exercised on that date.
- (d) If the Vesting or exercise of a Right would arise in a period where Dealings by a Participant would be prohibited or the Board determines that the Vesting or exercise of a Right would otherwise be inappropriate in the circumstances, the Board may determine that Vesting or exercise will be delayed until such time as Dealings are permitted or appropriate. For the avoidance of doubt, the Board may determine that Vesting or exercise will be delayed only in relation to the affected Participant or in relation to some or all Participants (irrespective of whether they are subject to the Dealing restriction).
- (e) At the time an Offer is made or at any time prior to Vesting or exercise (if applicable) of the Right, the Board may determine that the Vesting (and if applicable, exercise) of some or all Rights will be satisfied by:
  - (1) an allocation of Shares; and/or
  - (2) making a cash payment under rule 2.4 (instead of an allocation of Shares).
- (f) If no determination is made, the Vesting (and, if applicable, exercise) of a Right will be satisfied by the Company allocating Shares to the Participant pursuant to rule 2.3.
- (g) The Participant has no entitlement to receive a Share or a cash payment under rule 2.2(e) until the Rights have Vested, and if applicable, been exercised.

### 2.3 Allocation

- (a) Subject to rules 2.2(e), 2.3(b) and 2.3(c), where Vesting (and if applicable, exercise) of a Right will be satisfied by an allocation of Shares under rule 2.2(e), as soon as practicable following Vesting (and if applicable, exercise) of a Right, the Board must issue to, procure the transfer to, or procure the setting aside for, the Participant the number of Shares in respect of which Rights have Vested or been exercised (as applicable), less any Tax required to be withheld. No further action is required on the part of the Participant.
- (b) In the case of Rights held by or on behalf of a Participant who is a Director, Vested (and if applicable, exercised) Rights must be satisfied by Shares that have been purchased on market, unless:
  - (1) no shareholder approval is required under the Listing Rules in respect of the Director's participation in the Offer; or
  - (2) shareholders have approved the Director's participation in the Offer to the extent required under the Listing Rules.
- (c) If the allocation of a Share would arise in a period where Dealings by a Participant would be prohibited or the Board determines that the allocation of a Share would otherwise be inappropriate in the circumstances, the Board may determine that allocation will be delayed until such time as Dealings are permitted or appropriate.

### 2.4 Payment of cash equivalent

- (a) Where the Board determines under rule 2.2(e) to make a cash payment to a Participant in lieu of an allocation of Shares, the Company must pay to the Participant an amount in Australian dollars (or any other currency determined by the Board in its absolute discretion) equivalent to the value of the Shares underlying the relevant Rights that the Board determines will be settled by making a cash payment.
- (b) The amount of the cash payment referred to in rule 2.4(a) will be calculated by multiplying the number of Shares underlying the Rights that the Board determines will be settled by making a cash payment by the Current Market Price (less any Tax required to be withheld).

## 2.5 Lapse of Rights

- (a) A Right will lapse upon the earliest to occur of:
- (b) 10 years after the date on which the Right was allocated to the Participant, or any date specified as the expiry date in the Offer, other than a Vested but unexercised Right which will be automatically exercised on the applicable expiry date;
- (c) the Right lapsing in accordance with a provision of these Rules (including in accordance with a term of an Offer);
- (d) failure to meet a Vesting Condition or any other condition applicable to the Right within the Vesting Period; or
- (e) the receipt by the Company of a notice in writing from a Participant to the effect that the Participant has elected to surrender the Right.

## 3 Options

---

### 3.1 Grant

- (a) Where an Eligible Employee has accepted an Offer to participate in a grant of Options in accordance with rule 1.3(a), the Board will, subject to its discretion under rule 1.3(b), grant Options to the Eligible Employee.
- (b) Unless the Board determines otherwise or otherwise specified in an Offer:
  - (1) no payment is required for the grant of an Option; and
  - (2) Options may not be registered in any name other than that of the Eligible Employee; and
  - (3) where the Offer is made to an Eligible Employee in Australia, subdivision 83A-C of the Tax Act applies to the Options (subject to the requirements of the Tax Act).

### 3.2 Vesting

- (a) Subject to any express rule to the contrary, an Option will only Vest and become exercisable where each Vesting Condition, and all other relevant conditions advised to the Participant by the Board pursuant to rule 1.2, have been satisfied or otherwise waived by the Board.
- (b) Vesting occurs upon notification from the Company (or its delegate) to the Participant that an Option has Vested pursuant to this rule 3.2.
- (c) The exercise of an Option will be effected in the form and manner determined by the Company and, subject to rule 3.4, must be accompanied by payment of the relevant Exercise Price (if any) either in cleared funds or via any cashless exercise mechanism. The Company will notify the Participant of the process for exercise of Options that Vest, including any cashless exercise mechanism available to the Participant.

- For personal use only
- (d) If the Vesting or exercise of an Option would arise in a period where Dealings by a Participant would be prohibited, or the Board determines that the Vesting or exercise of an Option would otherwise be inappropriate in the circumstances, the Board may determine that Vesting or exercise will be delayed until such time as Dealings are permitted or appropriate. For the avoidance of doubt, the Board may determine that Vesting or exercise will be delayed only in relation to the affected Participant or in relation to some or all Participants (irrespective of whether they are subject to the Dealing restriction).
  - (e) At the time an Offer is made or at any time prior to exercise of the Option, the Board may determine that the exercise of some or all Options will be satisfied by:
    - (1) an allocation of Shares; and/or
    - (2) a cash payment under rule 3.4 (instead of an allocation of Shares).
  - (f) If no determination is made, the exercise of an Option will be satisfied by the Company allocating Shares to the Participant.
  - (g) The Participant has no entitlement to receive a Share or a cash payment under rule 3.2(e) until the Options have been exercised.

### 3.3 Allocation following exercise

- (a) Subject to rules 3.3(b) and 3.3(c), where exercise of an Option will be satisfied by an allocation of Shares under rule 3.2(e) as soon as practicable following the exercise of an Option, the Board must issue to, procure the transfer to, or procure the setting aside for, the Participant the number of Shares in respect of which Options have been exercised, less any Tax required to be withheld (adjusted as appropriate where a cashless exercise mechanism has been utilised by the Participant). No further action is required on the part of the Participant.
- (b) In the case of Options held by or on behalf of a Participant who is a Director, Vested Options must be satisfied by Shares that have been purchased on market, unless:
  - (1) no shareholder approval is required under the Listing Rules in respect of the Director's participation in the Offer; or
  - (2) shareholders have approved the Director's participation in the Offer to the extent required under the Listing Rules.
- (c) If the allocation of a Share would arise in a period where Dealings by a Participant would be prohibited or the Board determines that the allocation of a Share would otherwise be inappropriate in the circumstances, the Board may determine that allocation will be delayed until such time as Dealings are permitted or appropriate.

### 3.4 Payment of cash equivalent

- (a) Where the Board determines under rule 3.2(e) to make a cash payment to a Participant in lieu of an allocation of Shares, the Company must as soon as reasonably practicable:
  - (1) refund any amount paid (if any) by the Participant to exercise those Options; and
  - (2) pay to the Participant an amount in Australian dollars (or any other currency determined by the Board in its absolute discretion) determined under rule 3.4(b).
- (b) The amount of the cash payment referred to in rule 3.4(a) will be calculated by multiplying the number of Shares underlying the Options that the Board determines will be settled by making a cash payment by the Current Market Price, less the total of any Exercise Price that would otherwise have been payable in respect of those Options and any Tax required to be withheld.

### 3.5 Lapse of Options

An Option will lapse upon the earliest to occur of:

- (a) 10 years after the date on which the Option was allocated to the Participant, or any date specified as the expiry date in the Offer (unless the Board determines that the Options will be exercised on the expiry date by way of a cashless exercise mechanism);
- (b) the Option lapsing in accordance with a provision of these Rules (including in accordance with a term of an Offer);
- (c) failure to meet a Vesting Condition or any other condition applicable to the Option within the Vesting Period; or
- (d) the receipt by the Company of a notice in writing from a Participant to the effect that the Participant has elected to surrender the Option.

## 4 Restricted Shares

---

### 4.1 Allocation

- (a) After an Eligible Employee has accepted an Offer to participate in a grant of Restricted Shares in accordance with rule 1.3(a), the Board must, subject to its discretion under rule 1.3(b) and rule 4.1(b), allocate the Restricted Shares in accordance with any timeframe specified in the Offer by either:
  - (1) issuing Restricted Shares to;
  - (2) procuring the transfer of Restricted Shares to; or
  - (3) procuring the setting aside of Restricted Shares for, the Eligible Employee.
- (b) If the allocation of a Restricted Share would arise in a period where Dealings by a Participant would be prohibited or the Board determines that the allocation of a Restricted Share would otherwise be inappropriate in the circumstances, the Board may determine that allocation will be delayed until such time as Dealings are permitted or appropriate. For the avoidance of doubt, the Board may determine that allocation will be delayed only in relation to the affected Participant or in relation to some or all Participants (irrespective of whether they are subject to the Dealing restriction).
- (c) Unless the Board determines otherwise or otherwise specified in an Offer:
  - (1) no payment is required for the grant of a Restricted Share (other than a Restricted Share purchased pursuant to rule 4.2); and
  - (2) Restricted Shares may not be registered in any name other than that of the Eligible Employee or the Trustee.

### 4.2 Restricted Shares purchased by salary sacrifice

Notwithstanding anything else in these Rules:

- (a) Offers of Restricted Shares made pursuant to this rule 4.2 constitute Offers made under a separate reduction in the Participant's pre-tax remuneration (**Salary Sacrifice**) provision of these Rules.
- (b) Offers made to Eligible Employees in Australia pursuant to this separate provision will allow a Participant to agree to acquire Restricted Shares in return for a Salary Sacrifice that would not have happened apart from that Offer of not more than A\$5,000 per year ending 30 June (or such other amount specified by subsection 83A-105(4) of subdivision 83A-C of the Tax Act to be the maximum amount of discount to which that subsection can apply).



- (c) Subdivision 83A-C of the Tax Act applies to Offers made pursuant to this separate Salary Sacrifice provision of these Rules.

#### **4.3 Restricted Shares that are tax-exempt**

Notwithstanding anything else in these Rules:

- (a) Offers of Restricted Shares made pursuant to this rule 4.3 constitute Offers made under a separate tax-exempt provision of these Rules.
- (b) Offers of Restricted Shares under this rule 4.3 are made on a non-discriminatory basis in relation to at least 75% of the Australian resident permanent employees of the relevant employer who have completed at least 3 years of service (whether continuous or non-continuous).
- (c) Subdivision 83A-B of the Tax Act applies to Offers made pursuant to this tax exempt provision of these Rules.
- (d) A Restricted Share allocated to a Participant under this rule 4.3 will be subject to a restriction period from the date that the Restricted Shares are allocated until the earlier of:
- (1) the date that is three years from the date of allocation (or such other period that may be required under Subdivision 83A-B of the Tax Act, including such earlier time as the Commissioner of Taxation allows in accordance with section 83A-45(5) of the Tax Act); and
  - (2) the date on which the Participant ceases to be employed by the Group.
- (e) Restricted Shares allocated to a Participant under this tax-exempt provision of the Rules cannot be forfeited.

#### **4.4 Cessation of restrictions**

- (a) Subject to any express rule to the contrary, a Share only ceases to be a Restricted Share (e.g, Vests) where:
- (1) the Vesting Period and each other relevant condition (including all Vesting Conditions) advised to the Participant by the Board pursuant to rule 1.2 have been satisfied or otherwise waived by the Board; and
  - (2) the Company notifies the Participant that the restrictions in respect of the Restricted Share have ceased or no longer apply.
- (b) Subject to the terms of an Offer and the Securities Dealing Policy, when a Share ceases to be a Restricted Share, all restrictions on disposing of, or otherwise Dealing with, that Share, as set out in these Rules or the terms of an Offer, will cease.
- (c) If the Vesting of a Restricted Share would arise in a period where Dealings by a Participant would be prohibited or would otherwise be inappropriate in the circumstances, the Board may determine that Vesting will be delayed until such time as Dealings are permitted or appropriate. For the avoidance of doubt, the Board may determine that Vesting will be delayed only in relation to the affected Participant or in relation to some or all Participants (irrespective of whether they are subject to the Dealing restriction).

- (d) Unless provided otherwise in the terms of an Offer, when a Share that is held by the Trustee on behalf of a Participant ceases to be a Restricted Share, the Trustee will continue to hold the Share on trust on behalf of the Participant until such time as the Participant, or the Company on behalf of the Participant, directs the Trustee to:
- (1) transfer the Share into the Participant's name or:
    - (A) to another account the Participant nominates; or
    - (B) to an account to be held on the Participant's behalf; or
  - (2) sell the Share and pay the proceeds of sale (net of any applicable brokerage, commission, stamp duty or other transaction costs) to the Participant.

#### **4.5 Forfeiture of Restricted Shares**

Subject to rule 4.3(e), a Restricted Share will be forfeited upon the earliest to occur of the:

- (a) Restricted Share being forfeited in accordance with a provision of these Rules (including in accordance with a term of an Offer);
- (b) failure to meet a Vesting Condition or any other condition applicable to the Restricted Share within the Vesting Period; or
- (c) receipt by the Company of a notice in writing from a Participant to the effect that the Participant has elected to surrender the Restricted Share.

### **5 Units**

---

#### **5.1 Grant**

- (a) Where an Eligible Employee has accepted an Offer to participate in a grant of Units in accordance with rule 1.3(a), the Board must, subject to its discretion under rules 1.3(b) and 5.2(b) grant Units to the Eligible Employee.
- (b) Unless the Board determines otherwise:
  - (1) no payment is required for the grant of a Unit; and
  - (2) Units may not be recorded in any name other than that of the Eligible Employee.

#### **5.2 Vesting**

- (a) Subject to any express rule to the contrary, a Unit granted under these Rules will only Vest where each Vesting Condition, and all other relevant conditions advised to the Participant pursuant to rule 1.2, have been satisfied or otherwise waived by the Board.
- (b) If the Vesting of a Unit would arise in a period where Dealings by a Participant would be prohibited, or the Board determines that the Vesting of a Unit would otherwise be inappropriate in the circumstances, the Board may determine that Vesting will be delayed until such time as Dealings are permitted.
- (c) For the avoidance of doubt, the Board may determine that Vesting will be delayed only in relation to some or all Participants Units (irrespective of whether they are subject to the Dealing restriction).
- (d) The Vesting of a Unit will be satisfied by the Company making a cash payment in accordance with rule 5.3.
- (e) Vesting occurs on notification from the Company to the Participant that a Unit has Vested pursuant to this rule 5.2.

### **5.3 Payment of cash amount**

- (a) As soon as practicable following Vesting of a Unit in accordance with rule 5.2, the Company must make the cash payment referred to in rule 5.3(c) for each Unit that has Vested.
- (b) No further action is required on the part of the Participant.
- (c) In order to satisfy its obligation under rule 5.3(a), the Company must pay to the Participant an amount equivalent to the cash value of Units that have Vested (less any Tax required to be withheld).
- (d) Unless otherwise specified in the terms of an Offer, the amount of the cash payment referred to in rule 5.3(c) will be calculated by multiplying the number of Units that have Vested by the Current Market Price (less any Tax required to be withheld).

### **5.4 Lapse of Units**

A Unit will lapse on the earliest to occur of:

- (a) the Unit lapsing in accordance with a provision of these Rules (including in accordance with a term of an Offer);
- (b) failure to meet a Vesting Condition or any other condition applicable to the Unit within the Vesting Period; or
- (c) the receipt by the Company of a notice in writing from a Participant to the effect that the Participant has elected to surrender the Unit.

## **6 Cash Amounts**

---

### **6.1 Offer, Performance and Award**

- (a) Where an Eligible Employee has accepted an Offer to participate in an award of a Cash Amount in accordance with rule 1.3(a), the Board will, subject to its discretion under rule 1.3(b), (c) and 6.3, assess the extent to which the Vesting Conditions and all other relevant conditions have been satisfied over the Vesting Period, determine the Cash Amount to be awarded and advise the Eligible Employee of the Cash Amount that has been awarded. No further action is required on the part of the Participant.
- (b) Unless the Board determines otherwise or otherwise specified in an Offer, no payment is required for the award of a Cash Amount.
- (c) Notwithstanding the terms of any Offer made under rule 1.3, the Board may in its absolute discretion make any changes to the terms of the Offer prior to a Cash Amount being awarded. The Company will provide appropriate notification of the changes to the affected Eligible Employee or Participant.
- (d) A Cash Amount is awarded to a Participant upon notification from the Company (or its delegate) that the award has been made.

### **6.2 Payment of Cash Amounts**

- (a) The Cash Amount will be paid (less any Tax required to be withheld) to a Participant as soon as reasonably practicable following the award of the Cash Amount.
- (b) The Cash Amount will be payable by any Group Company.
- (c) The Cash Amount will be paid to the Participant through the payroll of the relevant Group Company.

- (d) The Company may determine in its absolute discretion the currency in which amounts will be paid.
- (e) Subject to any express rule to the contrary, a Cash Amount will only be awarded where each Vesting Condition, and all other relevant conditions advised to the Participant by the Board pursuant to rule 1.2, have been satisfied or otherwise waived by the Board.

### **6.3 Board Discretion in relation to Cash Amounts**

The Board may in its absolute discretion adjust (upwards or downwards) the Cash Amount awarded to a Participant, notwithstanding the application of the Vesting Conditions and any other relevant conditions. In exercising this discretion, the Board may have regard to one or more of the following considerations:

- (a) the personal performance and/or conduct of a Participant;
- (b) the performance of the division or function in which the Participant is employed or for which they have accountability, or which is relevant in relation to the Participant's role;
- (c) the performance of the Group or any Group company; and
- (d) any other factor which the Board reasonably determines is appropriate to take into account in relation to the Participant's Cash Amount.

### **6.4 Entitlement to Cash Amounts**

- (a) A Participant has no entitlement to be paid a Cash Amount unless and until the Cash Amount is awarded to them.
- (b) A Cash Amount will be forfeited:
  - (1) in accordance with a provision of these Rules (including in accordance with a term of an Offer); or
  - (2) on receipt by the Company of a notice in writing from a Participant to the effect that the Participant has elected not to receive the Cash Amount.

## **PART C**

---

### **7 Prohibited Dealings**

---

- (a) Subject to the Securities Dealing Policy, any Dealing in respect of an Incentive Security prior to Vesting is prohibited unless:
  - (1) the Board determines otherwise; or
  - (2) the Dealing is required by law and the Participant has provided satisfactory evidence to the Company of that fact.
- (b) Where, in the opinion of the Board, a Participant (or the Trustee at the Participant's direction) Deals with an Incentive Security in contravention of rule 7(a), the Incentive Security will immediately lapse or be forfeited.
- (c) The Board may, at its discretion, impose restrictions on Dealing in respect of any Shares allocated under these Rules (including upon Vesting or exercise of Rights or Options or at the request of the Participant) and may implement any procedure it considers appropriate to enforce such restrictions. Where a Participant requests that the Board impose restrictions on Dealing in respect of any Shares, the Board has the discretion to accept or reject such a request.

- (a) The Board may in its absolute discretion apply an adjustment (upwards or downwards) to the number of a Participant's Incentive Securities that Vest based on application of the Vesting Conditions and any other relevant conditions. In exercising this discretion, the Board may have regard to one or more of the following considerations:
  - (1) the personal performance and/or conduct of a Participant;
  - (2) the performance of the division or function in which the Participant is employed or for which they have accountability, or which is relevant in relation to the Participant's role;
  - (3) the performance of the Group or any Group company; and
  - (4) any other factor which the Board reasonably determines is appropriate to take into account in relation to the Participant's Incentive Securities.
- (b) Where the Board decides to reduce the number of a Participant's Incentive Securities that Vest, those Incentive Securities that would otherwise have Vested will instead lapse or be forfeited (as applicable).

9 Preventing inappropriate benefits

---

9.1 When the Board can take action

The Board may do any of the things in rule 9.2 where, in the opinion of the Board:

- (a) a Participant:
  - (1) has acted fraudulently or dishonestly;
  - (2) has engaged in gross misconduct;
  - (3) has engaged in an act which has brought the Company, the Group or any Group company into disrepute or may negatively impact the Company's, Group's or any Group company's reputation;
  - (4) has breached their duties or obligations to the Company or any Group company (including acting in breach of the terms and conditions of their employment or the Group's Code of Conduct);
  - (5) owes money or a debt to the Company or a Group company and has not otherwise agreed to an alternative arrangement with the Company or Group company (as applicable) to settle the debt owed; or
  - (6) is convicted of an offence or has a judgment entered against them in connection with the affairs of the Group;
- (b) a Participant's Incentive Securities Vest or may Vest, or a Participant's Cash Amount is awarded or may be awarded, as a result of the fraud, dishonesty, negligence or breach of duties or obligations of any other person (including a breach by that person of the terms and conditions of their employment or the Group's Code of Conduct) and, in the opinion of the Board, the Incentive Securities or Cash Amount will not or would not have otherwise Vested or been awarded;
- (c) a significant unexpected or unintended consequence, or a significant event, circumstance or outcome has occurred which impacts the Group or a Group company, including impacting its value, reputation or social licence to operate, where the original expected performance outcomes which the Incentive Securities were, or the Cash Amount was, intended to promote have not been realised;

- (d) the Company (or another Group company) is required or entitled to reclaim remuneration from a Participant or reduce a Participant's remuneration outcome under one or more of the following:
- (1) law;
  - (2) regulation, including a direction, standard or guidance from a regulator;
  - (3) contract; or
  - (4) Company or Group policy (as amended from time to time);
- (e) Vesting of some or all of the Participant's unvested Incentive Securities, payment of a dividend equivalent payment, or awarding of some or all of the Participant's Cash Amount, is not justified or supportable, having regard to any one or more of the following:
- (1) the personal performance and/or conduct of a Participant;
  - (2) the performance of the business unit or function in which the Participant is employed or for which they have accountability, or which is relevant in relation to the Participant's role;
  - (3) the performance of the Group or any Group company;
  - (4) a Financial Misstatement Circumstance;
  - (5) the Participant has contributed to circumstances giving rise to:
    - (A) a material loss to the Company;
    - (B) a material failure of risk management; or
  - (6) any other factor which the Board reasonably determines is appropriate to take into account in relation to the Participant's entitlements under these Rules; or
- (f) any additional circumstances specified in an Offer.

## 9.2 Actions the Board can take

Subject to rule 4.3(e), the Board may determine that any or all of the following occur:

- (a) a Participant's entitlement to an Incentive Security, dividend equivalent payment or Share (including a Share received on Vesting and exercise of an Option or Right) may be reduced or extinguished through lapse or forfeiture (as applicable);
- (b) any Share received may be required to be transferred to such person as the Company determines;
- (c) a Participant must pay or repay (as the case may be) to the Company as a debt:
  - (1) all or part of the net proceeds of sale where Shares allocated under these Rules have been sold;
  - (2) any cash payment received under these Rules; and/or
  - (3) any dividends, distributions or dividend equivalent payments received in respect of Incentive Securities or Shares allocated under these Rules; and/or
- (d) the restrictions on disposing or otherwise Dealing with a Participant's Restricted Shares are extended.

### 9.3 Investigations

In circumstances where:

- (a) the Board is considering the application of this rule 9;
- (b) a Participant is under investigation by the Group, a Group company or an external third party (including a regulator); or
- (c) such other circumstances specified in an Offer,

the Board may determine that any or all of the following will occur:

- (d) the Vesting, exercise and/or allocation of a Participant's Incentive Securities, and the awarding of a Participant's Cash Amount, be delayed or suspended (as appropriate) until such time as the Board determines (including until the final conclusion of any investigation under rule 9.3(b)); or
- (e) the restrictions on disposing or otherwise Dealing with a Participant's Restricted Shares are extended.

### 9.4 BHP Malus and Clawback Policy

- (a) Offers of Incentive Securities and Cash Amounts to Eligible Employees under these Rules are subject to the BHP Malus and Clawback Policy, as applicable and as amended from time to time.
- (b) If the Company is required to prepare an accounting restatement due to the material noncompliance of the Company with any financial reporting requirement under applicable law, including any required accounting restatement to correct an error in previously issued financial statements that is material to the previously issued financial statements, or that would result in a material misstatement if the error were corrected in the current period or left uncorrected in the current period, any Incentive-Based Compensation earned by a current or former Executive Officer during the three fiscal years preceding the required accounting restatement will be subject to the applicable recovery or "clawback" provisions of the BHP Malus and Clawback Policy.

### 9.5 Board's overriding discretion

For avoidance of doubt, and despite anything else in these rules, the Board has an overriding discretion to exercise any powers under this rule 9:

- (a) at each decision point relating to a grant of Incentive Securities, including during the applicable Vesting Period; and
- (b) whether or not the employment or engagement of the Participant has ceased.

## 10 Forfeiture of Shares

---

- (a) Where Shares (including Restricted Shares) are forfeited in accordance with these Rules and the Shares are held by the Participant, the Participant is deemed to have agreed to dispose of their legal and/or beneficial interest (as appropriate) in such Shares for nil consideration and the Shares will be transferred into the name of the Company's nominee who will then hold full legal and beneficial title to those Shares.
- (b) Where Shares (including Restricted Shares) are forfeited in accordance with these Rules and the Shares are held by the Trustee, the Participant's rights in the Shares will be extinguished for nil consideration. Where these Shares are already held by an employee share trust, the Shares will be held as general trust property in accordance with the terms of the Trust Deed, or in other cases, the Shares will be transferred into the name of the Company's nominee who will then hold full legal and beneficial title to those Shares. The Board may, at any time in the future, direct the Trustee to hold the Shares for the benefit of a different or new Participant.
- (c) Where a Participant forfeits Shares allocated to them on exercise of Options pursuant to these Rules, the Company may, but need not, repay to the Participant any Exercise Price paid by the Participant in respect of the forfeited Shares.

## 11 Cessation of employment

---

### 11.1 Board discretion on cessation

- (a) The Board, in its discretion, may determine that some or all of a Participant's unvested Incentive Securities, vested but unexercised Incentive Securities, and unawarded Cash Amounts, as applicable:
- (1) lapse;
  - (2) are forfeited;
  - (3) Vest (immediately or subject to conditions);
  - (4) are awarded (immediately or subject to conditions);
  - (5) are only exercisable for a prescribed period and will otherwise lapse;
  - (6) are subject to modified Vesting Conditions than those that previously applied; and/or
  - (7) are no longer subject to some or any of the restrictions (including any Vesting Condition) that previously applied,
- as a result of the Participant ceasing employment with the Group.
- (b) The Board may specify in the Offer to the Participant (in accordance with rule 1.2) how the Participant's Incentive Securities and Cash Amounts will be treated on cessation of employment. The applicable treatment may vary depending on the circumstances in which the Participant's employment ceases. In specifying a cessation treatment to apply to an Offer, the Board may preserve some or all of its discretion under rule 11.1(a).
- (c) Notwithstanding anything else in this rule 11, where:
- (1) a Participant ceases their employment with a Group company;
  - (2) the reason for the cessation is due to the transfer of the Participant's employment to another Group company or to a joint venture in which a Group company participates; and
  - (3) prior to the Participant ceasing employment, the CEO of the Company (or their delegate) consented to the transfer,
- the Participant will be treated as though their employment did not cease and rules 11.1(a) and 11.2 do not apply, unless the Board determines otherwise.

### 11.2 Post cessation discretions

- (a) The Board may exercise any of the post cessation discretions in rule 11.2(b) in respect of a Participant who has:
- (1) ceased to be employed by the Group; and
  - (2) received or may receive remuneration or favourable treatment under these Rules or any other plan or agreement with the Group in connection with their cessation of employment (including where entitlements Vest or remain on foot or are awarded after cessation of employment in accordance with their terms),
- where the Board determines in good faith that:
- (3) the Participant has breached a Post Cessation Covenant; or



- (4) a change in the Participant's circumstances since they ceased to be employed by the Group means it is no longer appropriate for the Participant to retain the benefits outlined in rule 11.2(a)(2) above. These circumstances may include, for example, where the Participant commences employment with a Competitor, or where the Participant purported to retire from the workforce and subsequently recommences employment.
- (b) For the purposes of rule 11.2(a) and subject to rule 4.3(e), the Board may do any one or more of the following:
- (1) deem any Cash Amount or unvested Incentive Securities of the Participant to have lapsed or be forfeited with effect from the date determined by the Board;
  - (2) deem all or any Shares (including Restricted Shares) allocated under these Rules that are still held by or on behalf of the Participant to be forfeited;
  - (3) where any Shares (including Restricted Shares) allocated to a Participant under these Rules (including on Vesting of Incentive Securities) have been sold by or on behalf of the Participant, require the Participant to pay all or part of the net proceeds of that sale to the Company as a debt; and/or
  - (4) where cash has been allocated to a Participant on Vesting of Incentive Securities, including in the form of a dividend or dividend equivalent payment made under rule 14.2, or where a Cash Amount has been paid, require the Participant to repay all or part of the cash to the Company as a debt.

### **11.3 Approved leave of absence**

Subject to applicable laws, at the discretion of the Board, a Participant who is granted an approved leave of absence and who exercises their right to return to work under any applicable award, enterprise agreement, other agreement, statute or regulation may be treated as not having ceased to be an employee for the purposes of the Rules. Whether a Participant who is granted leave without pay is deemed to have ceased employment will be determined with reference to the Group's policies and any applicable laws.

## **12 Change of Control**

---

### **12.1 Change of Control Events**

- (a) Where there is a Change of Control Event, the Board may, in its absolute discretion, determine the treatment of any Incentive Securities and/or Cash Amount, including that:
- (1) all or a specified number of a Participant's Incentive Securities remain on foot subject to the original terms of grant, Vest, lapse, be forfeited or cease to be subject to restrictions (as applicable); and
  - (2) all or a portion of a Participant's Cash Amount remain on foot subject to the original terms of grant, is awarded, lapses or is forfeited (as applicable).
- (b) For the avoidance of doubt:
- (1) a Change of Control Event does not include an internal reorganisation of the structure, business and/or assets of the Group; and
  - (2) if the Board does not make a determination pursuant to rule 12.1(a), then all of a Participant's Incentive Securities and Cash Amounts will remain on foot subject to the original terms of grant.

- (c) Any unvested Incentive Securities that do not Vest and unawarded Cash Amounts that do not become payable under rule 12.1(a) will lapse or be forfeited, unless the Board determines a different treatment.
- (d) The Board may specify in the Offer to the Participant (in accordance with rule 1.2) a particular treatment that will apply to unvested Incentive Securities and unawarded Cash Amounts in the context of a Change of Control Event or other change of Control.

## 12.2 Notification of Vesting

Where some or all of a Participant's Incentive Securities Vest and/or some or all of a Participant's Cash Amounts become payable pursuant to rule 12.1, the Company (or its delegate) will, as soon as reasonably practicable, give written notice to each Participant of the number of Incentive Securities that have Vested and the amount of the Cash Amount that has been awarded.

## 12.3 Treatment of Vested Incentive Securities

- (a) The Board has the discretion to determine the treatment of all Vested Incentive Securities (including those that Vest in accordance with rule 12.1) where a Change of Control Event occurs.
- (b) Without limiting the Board's discretion in rule 12.3(a), the Board may determine that all Vested Options and Rights must be exercised within a period specified by the Board and will lapse if not exercised within the specified period.

## 12.4 Acquisition of shares in Acquiring Company

- (a) If:
  - (1) a company (**Acquiring Company**) obtains Control of the Company as a result of a Change of Control Event; and
  - (2) the Company and the Acquiring Company agree,subject to applicable laws (including the Listing Rules) a Participant may, upon:
  - (3) Vesting (and, if applicable, exercise) of Rights; or
  - (4) exercise of Options,be provided with shares of the Acquiring Company or its parent or subsidiary in lieu of Shares in such manner as the Company and the Acquiring Company may agree (including by a replacement security or exchange of Shares issued on Vesting or exercise) and on substantially the same terms and on substantially the same conditions but with any necessary or appropriate adjustments to the number and kind of shares.
- (b) If rule 12.4(a) applies, the Participant appoints the Company as their agent to do anything needed to give effect to this arrangement, including agreeing to become a member of the Acquiring Company or its parent (as applicable).

## 12.5 Divestment of material business or subsidiary

- (a) Where the Company divests a business designated by the Board for this purpose as "material", the Board may make special rules that apply to some or all of an affected Participant's Incentive Securities and Cash Amount.
- (b) Without limiting the Board's discretion in rule 12.5(a), such rules may include varying the Vesting Condition and/or any other relevant conditions advised to a Participant and deeming that a Participant remains an employee of the Group for a specific period for the purposes of the relevant Offers.

- (c) As soon as reasonably practicable after making any special rules under this rule 12.5, the Board will give notice in writing of those special rules to any affected Participant.
- (d) Any special rules made under this rule 12.5 will not be considered amendments for the purposes of rule 17.

### 13 Power to adjust Rights, Options and/or Units and the Exercise Price

---

- (a) A grant of an Incentive Security carries no entitlement to participate in new issues of Shares by the Company prior to Vesting and exercise (if applicable) of the Incentive Security.
- (b) Subject to rule 13(c), prior to the allocation of Shares (or payment of an equivalent cash amount) to a Participant upon Vesting (and, if applicable, exercise) of Rights, Options or Units, the Board may grant additional Rights, Options or Units or make any adjustments it considers appropriate to the terms of a Right, Option and/or Unit granted to that Participant in order to minimise or eliminate any material advantage or disadvantage to a Participant resulting from a corporate action by, or capital reconstruction in relation to, the Company, including but not limited to any return of capital. Adjustments that may be made include adjustments to:
  - (1) the number of Rights, Options or Units to which the Participant is entitled;
  - (2) the number of Shares to which the Participant is entitled upon Vesting (and, if applicable, exercise) of Rights or exercise of Options;
  - (3) any amount payable on Vesting of Rights (and if applicable exercise) or exercise of Options (including the Exercise Price); or
  - (4) a combination of paragraphs (1), (2) and/or (3) above.
- (c) Without limiting rule 13(b), if:
  - (1) Shares are issued pro rata to the Company's shareholders generally by way of a rights issue, Options will be adjusted in accordance with ASX Listing Rule 6.22.2 (or any replacement rule);
  - (2) Shares are issued pro rata to the Company's shareholders generally by way of a bonus issue (other than an issue in lieu of dividends or by way of a dividend reinvestment) involving capitalisation of reserves or distributable profits, Options and Rights will be adjusted in the manner allowed or required by the ASX Listing Rules; or
  - (3) any reorganisation (including consolidation, subdivision, reduction or return) of the issued capital of the Company is effected, Options and Rights will be adjusted in the manner required by the ASX Listing Rules.
- (d) Where additional Rights, Options or Units are granted to the Participant under this rule 13, such Rights, Options or Units will be subject to the same terms and conditions as the original Rights, Options or Units granted to the Participant (including without limitation, any Vesting Conditions), unless the Board determines otherwise.
- (e) The Board must, as soon as reasonably practicable after making any additional grants or adjustments under this rule 13, give notice in writing to any affected Participant.

**14.1 Dividends and other rights associated with Shares**

- (a) Subject to the terms of any Trust Deed (if applicable) or Offer, the following rules apply in respect of Shares allocated to, or on behalf of, a Participant under these Rules (including Restricted Shares allocated under rule 4.1):
- (1) the Participant is entitled to receive all dividends and other distributions or benefits payable to the Participant or to the Trustee in respect of the Shares;
  - (2) the Participant is entitled to exercise, or to direct the Trustee in writing how to exercise, the voting rights attaching to the Shares, either generally or in a particular case;
  - (3) any bonus shares that are issued in respect of the Shares will be issued to the Participant, or to the Trustee on the Participant's behalf, and will be held by the Participant or Trustee as Shares subject to the same terms, conditions and restrictions on Dealing (if any) as the Shares in respect of which they were issued; and
  - (4) if rights arise on a rights issue in respect of the Shares, the Participant may Deal with or exercise those rights, or instruct the Trustee (if applicable) in relation to those rights in accordance with the Trust Deed. If the Shares are held by the Trustee on the Participant's behalf and the Participant does not instruct the Trustee how to Deal with the rights, the rights will be dealt with in accordance with the Trust Deed.

**14.2 Dividend equivalent payments and other rights**

- (a) Unless or until Shares are allocated to a Participant following Vesting or exercise of their Rights or Options (as applicable), the Participant has no interest in those Shares in respect of which the Right or Option was granted.
- (b) Notwithstanding rule 14.2(a), the Board may determine at the time an Offer is made that a dividend equivalent payment will be paid to a Participant who becomes entitled to an allocation of Shares (or equivalent cash amount) following the Vesting or exercise of Rights, Options or Units under that Offer (minus any applicable tax).
- (c) A Participant will have no right to receive a dividend equivalent payment made in respect of any Rights, Options or Units that lapse under these Rules.
- (d) Subject to the terms of any Offer, unless the Board determines otherwise, a dividend equivalent payment:
- (1) will only be paid following Vesting or exercise of Rights, Options or Units (as applicable);
  - (2) will be an amount determined by the Company that will be approximately equal to the amount of dividends that would have been payable to the Participant had they been the owner of the Shares referred to in rule 14.2(b) during the Vesting Period;
  - (3) will not be grossed up or otherwise adjusted to account for any tax consequences which would have applied if the Participant had actually been paid a dividend; and
  - (4) may be satisfied through the allocation of Shares or payment of cash.

## 15 Custody Arrangements

---

- (a) Legal title to any Shares which are due to be transferred to the Participant pursuant to the Plan may (notwithstanding any other Rule) be transferred to a person (the “**Custodian**”) appointed by the Company from time to time to hold legal title to such Shares on behalf of the Participant.
- (b) The Custodian will receive and hold Shares on behalf of the Participant in accordance with such terms and conditions as are agreed by the Company from time to time, and by participating in the Plan the Participant irrevocably agrees to those terms and conditions (which will be made available to the Participant on request to the Company).
- (c) The transfer of any Shares to the Custodian will satisfy any obligation of the Company under the Plan to transfer Shares to the Participant (and references in the Plan to Shares (or legal title thereof) having been transferred to the Participant will be read accordingly)

## 16 Withholding

---

- (a) Notwithstanding any other provisions of these Rules, if a Group company, the Trustee or a plan administrator is obliged, or reasonably believes it may have an obligation, as a result of or in connection with any:
  - (1) grant of Incentive Securities;
  - (2) allocation of Shares under these Rules; or
  - (3) payment of any amounts including a Cash Amount, cash equivalent amount or dividend equivalent amount, to account for any liability of a Participant, including:
  - (4) income tax or employment taxes under any wage, withholding or other arrangements; or
  - (5) any other Tax, social security contributions or levy or charge of a similar nature,then the relevant Group company, Trustee or plan administrator is entitled to withhold or be reimbursed by the Participant for the amount or amounts so paid or payable.
- (b) Where rule 16(a) applies, the relevant Group company, the Trustee or plan administrator is not obliged to grant any Incentive Securities, to allocate Shares or to make a cash payment in accordance with these Rules unless the Company is satisfied that arrangements for payment or reimbursement of the amounts referred to in rule 16(a) have been made. Those arrangements may include, without limitation:
  - (1) the provision by the Participant of sufficient funds to reimburse the relevant Group company, Trustee or plan administrator for the amount (by salary deduction, reduction of any amount owed by the Group to the Participant or otherwise);
  - (2) the sale on behalf of the Participant of Shares allocated pursuant to these Rules for payment or reimbursement of these amounts, as well as the costs of any such sale;
  - (3) a reduction in any amount payable to the Participant on Vesting of a Cash Amount or Units or in lieu of an allocation of Shares under these Rules;
  - (4) the Participant forgoing their entitlement to an equivalent number of Shares that would otherwise be allocated to the Participant; or

- (5) lapse or forfeiture of a portion of a Cash Amount or a sufficient number of Units, Rights, Options and/or Shares to satisfy the debt the Participant owes to the relevant Group company, Trustee or plan administrator.
- (c) Unless the Group company, Trustee or plan administrator (as applicable) and the Participant agree to use a different valuation, any Units, Rights, Options and/or Shares lapsed or forfeited (as applicable) under this rule will be valued at the Current Market Price on the date of lapse or forfeiture.
- (d) Any amounts which are paid or payable for the purposes of these Rules are inclusive of the Group's compulsory superannuation contribution (if applicable).
- (e) The Board may require any Participant, as a condition of the allocation of any Incentive Securities, to enter into an agreement transferring any liability of any Group company to social security contributions or any Tax in respect of those Incentive Securities or Shares.

## 17 Amendments

---

### 17.1 Power to make amendments

- (a) Subject to rule 17.2 and rule 6.1(c), the Board may at any time by resolution:
- (1) amend or add to (**amend**) all or any of the provisions of these Rules;
  - (2) amend the terms or conditions of any Incentive Security granted or Cash Amount Offered under these Rules; or
  - (3) suspend or terminate the operation of these Rules or any incentive plan operated in connection with these Rules.
- (b) Notwithstanding rule 17.2, the Board may waive, amend or replace any Vesting Condition attaching to an Incentive Security if the Board determines that the original Vesting Condition is no longer appropriate or applicable (including, without limitation, where a Vesting Condition refers to a particular stock market index that is no longer published or there is a corporate action by the Company, including a discounted rights issue, which impacts on the Vesting Condition), provided that the interests of the relevant Participant are not, in the opinion of the Board, materially prejudiced or advantaged relative to the position reasonably anticipated at the time of the grant.

### 17.2 Restrictions on amendments

Without the consent of the Participant, the Board may not exercise its powers under rule 17.1(a) in a manner which reduces the rights of the Participant in respect of any Incentive Security or Share already granted under these Rules other than an amendment introduced primarily:

- (a) for the purpose of complying with or addressing present or future laws or regulatory developments that apply to one or more of the following:
- (1) the remuneration and benefits of Participants (collectively or individually);
  - (2) awards of Incentive Securities; and
  - (3) these Rules or incentive plans generally;
- (b) to correct any manifest error or mistake; or
- (c) to take into consideration possible adverse tax implications arising from, amongst others, adverse rulings, changes to tax legislation and/or changes in the interpretation of tax legislation by a court of competent jurisdiction.

### **17.3 Notice of amendment**

As soon as reasonably practicable after making any amendment under rule 17.1, the Board will give notice in writing of that amendment to any Participant affected by the amendment.

## **18 Participants based overseas**

---

### **18.1 Overseas transfers**

If a Participant is transferred to work in another country and the Participant continues to hold an office or employment with the Group, the Board may decide that:

- (a) some or all of the Participant's Cash Amounts, Units or Restricted Shares will Vest;
- (b) some or all of the Participant's Options or Rights will Vest and if applicable, become exercisable;
- (c) some or all of the Participant's Options or Rights will be settled in cash in lieu of Shares;
- (d) some or all of the Participant's unvested Incentive Securities will be forfeited and replaced with cash or an entitlement to a future cash amount; or
- (e) any other treatment that the Board determines will apply in relation to some or all of a Participant's Incentive Securities or Cash Amounts,
- (f) with the balance (if any) continuing to be held on the original terms.

### **18.2 Non-Australian residents**

The Board may adopt additional rules that will apply to a grant made to an Eligible Employee who is a resident in a jurisdiction other than Australia. The remaining provisions of these Rules will apply subject to whatever alterations or additions the Board may determine having regard to any securities, exchange control, taxation or other laws and/or regulations or any other matter that the Board considers directly or indirectly relevant. To the extent of any inconsistency, any additional rules adopted by the Board under this rule will prevail over any other provision of these Rules.

### **18.3 Non-Australian taxpayers**

Where a Participant is resident for tax purposes outside of Australia, the Board may require, as a term of grant or Vesting, that the Participant enter into with the Company (or any Group company) any tax election as may be required in respect of the Incentive Securities or Shares to be allocated under these Rules.

## **19 Misleading statements and omissions where monetary consideration is provided by Participants**

---

The provisions of this rule 19 apply only where an Offer of Incentive Securities is received in Australia and the Participant pays or provides monetary consideration under the terms of the Offer.

### **19.1 Additional disclosure**

The terms of an Offer, comprising these Rules, the Offer made under rule 1 and any supporting information (collectively in this rule 19 the 'Offer Documents'), must comply with any applicable disclosure obligations under Division 1A of Part 7.12 of the Corporations Act as amended from time to time.

## 19.2 Misleading Statements and Omissions

- (a) The Offer Documents must not include a misleading or deceptive statement and must not omit any information that would result in the Offer Documents being misleading or deceptive.
- (b) The Company must provide the Participant with an updated offer document as soon as practicable after becoming aware during the application period stated in the Offer Document that an Offer Document provided to a Participant has become out of date, or is otherwise not correct, in a material respect.
- (c) The directors of the Company or any person named, with their consent, in the Offer Documents (each a '**Relevant Person**') must notify the Company in writing as soon as practicable if, during the application period stated in the Offer Documents, the Relevant Person becomes aware that:
  - (1) a material statement in the Offer Documents is misleading or deceptive;
  - (2) information was omitted from any of the Offer Documents that has resulted in one or more of the Offer Documents being misleading or deceptive; or
  - (3) a new circumstance has arisen during the application period which means the Offer Document is out of date, or otherwise not correct, in a material respect.

## 19.3 Liability

Subject to rule 19.4, a participant who suffers loss or damage because of a contravention of rule 19.2, may recover the amount of the loss or damage from:

- (a) the Company;
- (b) each director of the Company;
- (c) each person named in the Offer Documents, with their consent, as a proposed director of the Company;
- (d) in the case of a misleading or deceptive statement or omission — a person named, with their consent, in the Offer Documents as having made the misleading or deceptive statement, or a statement on which the misleading or deceptive statement is based; and
- (e) in the case of a failure by a Relevant Person to notify the Company of a misleading or deceptive statement, omission or new circumstance — the Relevant Person.

## 19.4 Limitation of Liability

The Company or a Relevant Person is not liable for any loss or damage suffered by a Participant because of a contravention of rule 19.2, if:

- (a) the Company or the Relevant Person made all inquiries (if any) that were reasonable in the circumstances and, after doing so, believed on reasonable grounds that the statement was not misleading or deceptive;
- (b) the Company or the Relevant Person did not know that the statement was misleading or deceptive;
- (c) the Company placed reasonable reliance on information given to the Company by someone other than a director, employee or agent of the Company, or the Relevant Person placed reasonable reliance on information given to the Relevant Person by someone other than an employee or agent of the Relevant Person;



- (d) if the Relevant Person is a person who was named, with their consent, in the Offer Documents, as a proposed director of the Company or otherwise, the person proves that they publicly withdrew their consent to being named in the Offer Documents in that way; or
- (e) the contravention arose because of a new circumstance that arose since the Offer Document was prepared and the Relevant Person proves that they were not aware of the matter.

## **20 Miscellaneous**

---

### **20.1 Shares issued under these Rules**

- (a) Any Shares issued under these Rules will rank equally in all respects with other Shares for the time being on issue by the Company (for example, having rights with respect to voting, dividends and other distributions, and in the event of a winding up of the Company), except
  - (1) in relation to any rights attaching to such Shares by reference to a record date prior to the date of their issue; or
  - (2) as provided for in accordance with rule 14.1.
- (b) If the Company is listed, the Company will apply for quotation of Shares issued under these Rules within the period required by the Listing Rules.

### **20.2 Rights and obligations of Participants**

- (a) An Eligible Employee has no right to receive an Offer under these Rules.
- (b) Unless the subject of an express provision in an employment contract, the rights and obligations of any Participant under the terms of their office, employment or contract with the Group are not affected by their participation in the Offer.
- (c) Participation in the Offer does not confer on any Participant any right to future employment and does not affect any rights which any member of the Group may have to terminate the employment of any Participant.
- (d) These Rules will not form part of and are not incorporated into any contract of any Participant (whether or not they are an employee of the Group) including, for the avoidance of doubt, any contract of employment between the Participant and any past or present Group company.
- (e) The grant of Incentive Securities or an offer of a Cash Amount on a particular basis in any year does not create any right or expectation of the grant of Incentive Securities or an offer of a Cash Amount on the same basis, or at all, in any future year.
- (f) No Participant has any right to compensation for any loss in relation to these Rules or an Offer, including:
  - (1) any loss or reduction of any rights or expectations under these Rules or an Offer in any circumstances or for any reason (including lawful or unlawful termination of employment or the employment relationship);
  - (2) any exercise of a discretion or a decision taken in relation to a grant of Incentive Securities or an offer of a Cash Amount or in relation to these Rules, or any failure to exercise a discretion under these Rules;
  - (3) the operation, suspension, termination or amendment of these Rules or any Offer; or

- (4) lapse or forfeiture (as applicable) of any Incentive Securities or Cash Amount.
- (g) The Participant irrevocably appoints each company secretary of the Company (or any other officer of the Company authorised by the Board for this purpose) as their attorney to do anything necessary to:
- (1) allocate Shares to the Participant in accordance with these Rules;
  - (2) effect a forfeiture of Shares in accordance with these Rules (including rule 10 or the terms of an Offer); and
  - (3) execute transfers of Shares in accordance with these Rules,
- and the Participant acknowledges that this irrevocable attorney is deemed to be given for valuable consideration.
- (h) The invalidity or non-enforceability of any provision or Rule will not affect the validity or enforceability of the remaining provisions and Rules which will continue in full force and effect.
- (i) Notwithstanding any provisions of these Rules, if required by the Company the transfer of Shares on Vesting will be conditional on the Participant entering into (and may be delayed until the Participant has entered into), such documentation as is reasonably required to facilitate the holding of legal title to Shares on behalf of the Participant by any nominee (including a custodian), which may include any documentation in respect of “know-your-client” processes or worldwide common reporting processes.

### **20.3 Power of the Board to administer these Rules**

- (a) These Rules are administered by the Board which has power to:
- (1) determine procedures for administration of these Rules, including to implement an employee share trust (or to impose a holding lock) for the purposes of delivering and holding Shares on behalf of Participants upon the grant of Restricted Shares or the Vesting (and, if applicable, exercise) of Rights or exercise of Options; and
  - (2) delegate to any one or more persons for such period and on such conditions as it may determine the exercise of any of its powers or discretions arising under these Rules.
- (b) Except as otherwise expressly provided in these Rules, the Board has absolute and unfettered discretion to act or refrain from acting under or in connection with these Rules and in the exercise of any power or discretion under these Rules.

### **20.4 Overriding Board discretion**

Subject to rule 4.3(e), the Listing Rules and any other applicable law, and notwithstanding any other provision of these Rules or the terms of an Offer, the Board may, in its absolute discretion, determine that a Cash Amount or the number of Rights, Options, Units and/or Restricted Shares that Vest will be greater or lower than the Cash Amount or the number of Rights, Options, Units and/or Restricted Shares which would otherwise have been eligible to Vest in accordance with these Rules and the terms of the applicable Offer.

### **20.5 Waiver of terms and conditions**

Notwithstanding any other provision of these Rules, the Board may at any time waive in whole or in part any terms or conditions (including any Vesting Condition) in relation to any Cash Amounts or Incentive Securities or Shares granted to a Participant.

## 20.6 Application of constitution of the Company, Corporations Act, Listing Rules and other applicable laws

- (a) Offers under these Rules must be operated in accordance with the constitution of the Company, the Corporations Act, the Listing Rules, other applicable laws and regulations (including the EU Market Abuse Regulation (regulation (EU) 596/2014), retained in UK law as “UK MAR”).
- (b) Notwithstanding any other provisions of these Rules, Incentive Securities and Shares will not be allocated, issued, acquired, transferred or otherwise dealt with under these Rules, and no other benefit will be deliverable under these Rules, if to do so would:
  - (1) contravene the constitution of the Company, the Corporations Act, the Listing Rules, or any other applicable laws (including any applicable foreign law);
  - (2) give rise to unreasonable cost or regulatory requirements for the Company or any Group company; or
  - (3) require the Company or any Group company to pay, provide, or procure the payment or provision of, any money or benefits to the Participant which would require shareholder approval under Part 2D.2, Division 2 of the Corporations Act.
- (c) For the avoidance of doubt, the Company has no obligation to seek shareholder approval to deliver any benefit under these Rules that cannot be delivered without shareholder approval.

## 20.7 Error in Allocation

- (a) If any Incentive Security is provided under these Rules in error or by mistake to a person (**Mistaken Recipient**) who is not the intended recipient, the Mistaken Recipient will have no right or interest, and will be taken never to have had any right or interest in, that Incentive Security and the Incentive Security will immediately lapse or be forfeited (as applicable).
- (b) If any cash payment is paid under these Rules in error or by mistake to a person who is not the intended recipient (**Mistaken Recipient**), the Mistaken Recipient will have no right to retain that cash payment and the Company may take whatever steps it deems reasonably necessary to seek repayment of that cash payment as a debt.

## 20.8 Exchange Rate

A payment under these Rules may be made in a currency other than Australian dollars, in which case the amount of such payment will be converted into such other currency on such basis as the Board may reasonably decide.

## 20.9 Dispute or disagreement

In the event of any dispute, disagreement or uncertainty as to the interpretation of these Rules, or as to any question or right arising from or related to these Rules or to any Incentive Securities, Cash Amounts or Shares granted under it, the decision of the Board is final and binding.

## 20.10 Communication

Any notice or other communication provided to a Participant under or in connection with these Rules may be given by personal delivery or by sending it by post or email to the Participant, or by posting it on the Company’s intranet.

## 20.11 Data protection

- (a) Subject to any applicable laws, by participating in an Offer, the Participant consents to the holding and processing of personal data or other similar matters set out in the Offer provided by the Participant to the Group, the plan administrator or the Trustee, for all purposes with regard to the operation of these Rules. These include, but are not limited to:
- (1) administering and maintaining Participant records;
  - (2) providing information to the Trustee, registrars, brokers, printers or third party plan administrators;
  - (3) providing information to any regulatory authority (including the Australian Taxation Office) where required under law; and
  - (4) providing information to future purchasers of a Group company or the business in which the Participant works.
- (b) Without limiting the terms of an Offer, by participating in an Offer and allowing the Company to grant Incentive Securities or award a Cash Amount under these Rules, the Participant:
- (1) acknowledges that the Group, the plan administrator and/or the Trustee may be required or authorised to collect the personal data under laws including the Tax Act, the *Taxation Administration Act 1953* (Cth) and the Corporations Act, and that limited details about shareholders are available to members of the public on request;
  - (2) confirms they have reviewed the Privacy Policy, and acknowledges that the Privacy Policy applies to the Group's handling of their personal data, and contains further details about the countries to which personal data may be disclosed, requesting access to and updating of personal data and how to raise queries and concerns; and
  - (3) agrees that if their personal data is disclosed to a third party in a country outside Australia, the Group will not be accountable under Australian privacy law for the conduct of the recipient in relation to that personal data, and the Participant may not be able to seek redress under Australian privacy law.
- (c) Without limiting rules 20.11(a) or 20.11(b), by allowing the Company to grant Incentive Securities or award a Cash Amount under these Rules, the Participant agrees, subject to rule 20.11(d):
- (1) the Australian tax file number (**TFN**) or foreign equivalent tax identification number (**TIN**) they have provided to the Group as an employee of the Group (where applicable) being provided to any plan administrator, as agent for the Company and also as administrator of these Rules; and
  - (2) their TFN or TIN (where applicable) being provided to the Australian Taxation Office and any other regulatory authorities, including in foreign jurisdictions as required and permitted under law.
- (d) Rule 20.11(c) is voluntary and the Participant should notify the Company if they wish to withdraw agreement to that rule at any time. Participants who withdraw agreement from rule 20.11(c) may be subject to withholding tax deductions under the *Taxation Administration Act 1953* (Cth).
- (e) To the extent that the processing of the personal data of a Participant is not subject to EU Regulation 2016/679 (**EU GDPR**), the UK General Data Protection Regulation (**UK GDPR**) or the UK Data Protection Act 2018, each Participant consents to the holding and processing of personal data as referred to in this rule 20.11.

- (f) Rule 20.11(e) does not apply in respect of any Participant the processing of whose personal data is subject to EU GDPR, UK GDPR or the UK Data Protection Act 2018 and the legal grounds for the processing of the personal data of such Participant will (depending on the nature and purpose of any specific instance of processing) be one of:
- (1) such processing being necessary for the purposes of the legitimate interests of the Company and each other Group company in incentivising their officers and employees and operating these Rules;
  - (2) such processing being necessary for the purposes of any relevant data controller in respect of such personal data complying with its legal obligations; and
  - (3) such processing being necessary for the performance of the contractual obligations arising under these Rules.

The collection and processing of such personal data for such purposes is a contractual requirement of participation in these Rules. Details in relation to the processing of such personal data referred to in this rule 20.11(f), and of the Participant's rights in connection with such processing, are available in the Global Employee Privacy Notice (or any similar provisions of any employee privacy policy or employee handbook) operated from time to time by any Group company in respect of such Participant, and any such Participant may obtain such notice or policy from their employing company.

The personal data to be processed as referred to in this Rule 20.11 may be disclosed or transferred to, and/or processed by: (i) any professional advisors of any Group company, any revenue, regulatory or governmental authorities, (ii) a Trustee; any registrars, brokers, other third party administrators (or similar) appointed in connection with any employee share or incentive plans operated by any Group company, or any person appointed (whether by the Participant or any Group company) to act as nominee on behalf of (or provide a similar service to) the Participant; (iii) subject to appropriate confidentiality undertakings, any prospective purchasers of, and/or any person who obtains Control of or acquires, the Company or the whole or part of the business of the Group; or (iv) any Group Company and officers, employees or agents of such Group company.

In this rule 20.11(f), "personal data" and "data controller" each have the meaning given in EU GDPR or UK GDPR as appropriate.

#### **20.12 Tax**

Unless otherwise required by law, no Group Company is responsible for any Tax which may become payable by a Participant as a consequence of or in connection with the grant of any Incentive Securities, payment of Cash Amounts, the allocation of any Shares or any Dealing with any Incentive Securities or any Shares.

#### **20.13 Laws governing these Rules**

These Rules, and any Cash Amounts offered and awarded, Incentive Securities granted and Shares allocated under them, are governed by the laws of Victoria and the Commonwealth of Australia.

## PART D

### 21 Definition and Interpretation

#### 21.1 Definitions

<u>Term</u>	<u>Meaning</u>
<b>Acquiring Company</b>	has the meaning given in rule 12.4(a)
<b>ASX</b>	ASX Limited ACN 008 624 691 or the Australian Securities Exchange, as the context requires
<b>BHP Malus and Clawback Policy</b>	the Group's policy regarding malus and clawback in respect of Incentive Securities and Cash Amounts, as amended from time to time
<b>Board</b>	the board of directors of the Company, any committee of the board or a person or body to which the board has delegated its powers, or some of its powers, for the purposes these Rules
<b>Cash Amount</b>	a cash bonus amount receivable by an Eligible Employee under these Rules subject to satisfaction of applicable conditions (including any Vesting Conditions or Vesting Period)
<b>Change of Control Event</b>	where there is a: <ol style="list-style-type: none"><li>1 Takeover Bid for Shares; or</li><li>2 other transaction, event or state of affairs,</li></ol> that, in the Board's opinion, is likely to result in, or should otherwise be treated as, a change in the Control of the Company
<b>Code of Conduct</b>	the Company's Code of Conduct (or equivalent), as amended or replaced from time to time
<b>Company</b>	BHP Group Limited ACN 004 028 077
<b>Competitor</b>	any business that competes with the Group or a Group company
<b>Control</b>	has the meaning given in section 50AA of the Corporations Act
<b>Corporations Act</b>	<i>Corporations Act 2001</i> (Cth)

<u>Term</u>	<u>Meaning</u>
<b>Current Market Price</b>	the arithmetic average of the daily volume weighted average market price (rounded to the nearest cent) of all Shares traded on the ASX during the previous ten trading days, or any other calculation as determined by the Board
<b>Custodian</b>	has the meaning given in rule 15
<b>Deal or Dealing</b>	<p>in relation to an Incentive Security or Share (as the case may be), any dealing, including but not limited to:</p> <ol style="list-style-type: none"> <li>1 a sale, transfer, assignment, encumbrance, option, swap, or any other alienation of all or any part of the rights attaching to the Incentive Security or Share;</li> <li>2 any dealing, as that term is defined in the Company's Securities Dealing Policy;</li> <li>3 any attempt to do any of the actions set out in paragraph 1 above; and</li> <li>4 any hedging (including any dealing with a derivative instrument) intended to "lock in" a profit relating to an Incentive Security, and any other transactions in financial products that operate to limit the economic risk associated with holding an Incentive Security</li> </ol>
<b>Director</b>	a director of the Company
<b>Eligible Employee</b>	an employee of the Group (including a Director employed in an executive capacity) or any other person who is declared by the Board to be eligible to receive a grant of Incentive Securities or cash under these Rules
<b>Executive Officer</b>	has the meaning given in section 303A.14 of the NYSE Listed Company Manual
<b>Exercise Price</b>	the amount payable to exercise an Option following Vesting as set out in an Offer (as adjusted or amended in accordance with these Rules)
<b>Financial Misstatement Circumstance</b>	<ol style="list-style-type: none"> <li>1 a material misstatement or omission in the financial statements of a Group company; or</li> <li>2 any other circumstances or events which, in the opinion of the Board, may, or are likely to, affect the Group's financial soundness or require re-statement of the Group's financial statements,</li> </ol> <p>including, without limitation, as a result of misrepresentations, errors, omissions, or negligence</p> <p>a material misstatement or omission in the financial statements of a Group company or any other circumstances or events which, in the opinion of the Board, may, or are likely to, affect the Group's financial soundness or require re-statement of the Group's financial statements, including, without limitation, as a result of misrepresentations, errors, omissions, or negligence</p>

For personal use only

<b>Term</b>	<b>Meaning</b>
<b>Group</b>	the Company and each Related Body Corporate of the Company, including any other company or entity designated by the Board to be a Group company for the purposes of these Rules, and which includes BHP Mitsubishi Alliance Coal Operations Pty Ltd
<b>Group company</b>	a member of the Group or any other company or entity designated by the Board to be a Group company for the purposes of these Rules, and which includes BHP Mitsubishi Alliance Coal Operations Pty Ltd
<b>Incentive-Based Compensation</b>	has the meaning given in section 303A.14 of the NYSE Listed Company Manual
<b>Incentive Security</b>	a Restricted Share, Right, Option and/or Unit (as the case may be)
<b>Listing Rules</b>	the official Listing Rules of the ASX and any other exchange on which the Company is listed as they apply to the Company from time to time
<b>Offer</b>	an invitation to an Eligible Employee made by the Company under rule 1.1 to apply for, participate in, or receive (as applicable), a grant of Incentive Securities or an award of a Cash Amount
<b>Option</b>	an entitlement to receive a Share or, in certain circumstances, to a cash payment, subject to satisfaction of applicable conditions (including any Vesting Condition) and compliance with the applicable exercise procedure (including payment of any applicable Exercise Price or compliance with any cashless exercise arrangement approved by the Board in its discretion)
<b>Participant</b>	a person who has been offered a Cash Amount or allocated an Incentive Security or Share under the terms of these Rules from time to time
<b>Post Cessation Covenant</b>	in respect of a Participant means: <ol style="list-style-type: none"> <li>1 a restriction or undertaking owed to the Group or a Group Company in connection with the Participant's former employment with the Group; or</li> <li>2 any compromise or contractual arrangement in relation to the cessation of the Participant's employment with the Group</li> </ol>
<b>Privacy Policy</b>	the Group's privacy policy, as amended from time to time, which can be found on the Group's website at <a href="https://www.bhp.com/privacy-policy">https://www.bhp.com/privacy-policy</a> , or such other Group policy in relation to privacy laws as applicable from time to time

For personal use only



<u>Term</u>	<u>Meaning</u>
<b>Related Body Corporate</b>	has the meaning given in section 50 of the Corporations Act
<b>Restricted Share</b>	a Share allocated in accordance with rule 4.1 that is subject to restrictions on Dealing, Vesting Conditions and/or other restrictions or conditions
<b>Right</b>	an entitlement to a Share or, in certain circumstances, to a cash payment, subject to satisfaction of applicable conditions (including any Vesting Condition) and compliance with any applicable exercise procedure
<b>Rules</b>	the terms and conditions set out in this document, as amended from time to time
<b>Securities Dealing Policy</b>	the Group policy for trading in securities (as amended or replaced from time to time) or such other Group policy in relation to trading or Dealing in Shares as applicable from time to time
<b>Share</b>	a fully paid ordinary share in the capital of the Company. A reference to a Share includes a reference to a Restricted Share
<b>Subsidiary</b>	has the meaning given in section 46 of the Corporations Act
<b>Takeover Bid</b>	has the meaning given in section 9 of the Corporations Act
<b>Tax</b>	includes any tax, levy, impost, goods and services tax, deduction, charge, rate, employee social security contribution, other contribution, duty or withholding which is assessed (or deemed to be assessed), levied, imposed or made by any government or any governmental, semi-governmental or judicial entity or authority in any part of the world, together with any interest, penalty, fine, charge, fee or other amount assessed (or deemed to be assessed), levied, imposed or made on or in respect of any or all of the foregoing
<b>Tax Act</b>	the <i>Income Tax Assessment Act 1997</i> (Cth)
<b>Trust Deed</b>	in relation to an Offer, any trust deed or custodian deed nominated by the Company as the Trust Deed for the purposes of the Offer, as amended from time to time

For personal use only

<b>Term</b>	<b>Meaning</b>
<b>Trustee</b>	the trustee under the Trust Deed and/or the custodian under the custodian deed (as applicable)
<b>Unit</b>	an entitlement to a cash payment that is equal to the Current Market Price of a specified number of Shares, also commonly known as a phantom share unit, subject to satisfaction of applicable conditions (including any Vesting Condition)
<b>Vest or Vesting</b>	<p>the process by which the holder of an Incentive Security becomes entitled to:</p> <ol style="list-style-type: none"> <li>1 in the case of a Right, exercise the Right (if applicable) or be allocated a Share (or equivalent cash payment) in accordance with rules 2.2 and 2.3;</li> <li>2 in the case of an Option, exercise the Option in accordance with rules 3.2 and 3.3;</li> <li>3 in the case of a Restricted Share, have all restrictions on disposing of or otherwise Dealing with the Restricted Share cease in accordance with rule 4.3 (other than any additional restrictions imposed by the Board under rule 7(c)); and</li> <li>4 in the case of a Unit, following the satisfaction of all Vesting Conditions that apply, being paid a cash payment in accordance with rules 5.2 and 5.3,</li> </ol> <p>and/or the process by which a Cash Amount is awarded to a Participant and becomes payable in accordance with rules 6.1 and 6.2</p>
<b>Vesting Condition</b>	performance, service or other conditions that must be satisfied or circumstances which must exist before an Incentive Security Vests or a Cash Amount is awarded under these Rules, advised to a Participant by the Board under rule 1.2
<b>Vesting Period</b>	the prescribed period for satisfaction of a Vesting Condition, advised to a Participant by the Board under rule 1.2

## 21.2 Interpretation

The following rules apply unless a contrary intention appears:

- (a) headings are for convenience only and do not affect the interpretation of these Rules unless the context requires otherwise;
- (b) any reference in these Rules to any statute or statutory instrument includes a reference to that statute or statutory instrument as amended, consolidated, re-enacted or replaced from time to time;
- (c) a reference to any agreement or document includes a reference to that agreement or document as amended, novated, supplemented or amended from time to time;
- (d) any words denoting the singular include the plural and words denoting the plural include the singular;
- (e) where any word or phrase is given a definite meaning in these Rules, any part of speech or other grammatical form of that word or phrase has a corresponding meaning;
- (f) the word “includes” in any form is not a word of limitation; and
- (g) any determination, decision or exercise of power, by the Board will be at its absolute discretion.

## Provisions applicable to US Taxpayers

---

This Addendum 1 contains certain rules and definitions that apply to any Participant who is subject to United States taxation, including any US tax resident or non-residents of the US who earn US-source compensation. The terms and conditions set out in this Addendum 1 apply to such US taxpayers and, as indicated in this Addendum 1, certain terms and conditions of these Rules will not apply to such US taxpayers. In the case of any conflict between the terms of these Rules and the terms of this Addendum 1 with respect to US taxpayers, the terms of this Addendum 1 will prevail.

### The Rules of **Part B** Section 2 (*Rights*)

---

#### 2.2 Vesting

With respect to a US taxpayer, where the exercise of the Right may be determined or postponed by the Board, the determination or postponement of the exercise date shall comply with the requirements of Section 409A of the Internal Revenue Code (the “Code”) to the extent applicable. The exercise date shall not be later than the tenth anniversary of the date of grant or earlier expiration date of the Right.

### The Rules of **Part B** Section 3 (*Options*)

---

#### 3.2 Vesting

With respect to a US taxpayer, where the exercise of the Option may be determined or postponed by the Board, the determination or postponement of the exercise date shall comply with the requirements of Section 409A of the Code to the extent applicable. The exercise date shall not be later than the tenth anniversary of the date of grant or earlier expiration date of the Option.

With respect to an Option granted to a US taxpayer, the Exercise Price must be not less than the fair market value of the Shares on the date of grant.

### The Rules of **Part B** Section 5 (*Units*)

---

#### 5.2 Vesting

With respect to a US taxpayer, where the satisfaction of the Vesting of the Unit may be determined or postponed by the Board, the determination or postponement of the satisfaction of the Vesting of the Unit shall comply with the requirements of Section 409A to the extent applicable.

### The Rules of **Part C** Section 11 (*Cessation of employment*)

---

With respect to any award of a Participant who is a US taxpayer which constitutes deferred compensation for the purposes of Section 409A, the Participant is to be treated as ceasing to be employed by any member of the Group for the purposes of these Rules when the Participant has a “separation from service” (as defined in Section 409A).

### The Rules of **Part C** Section 12 (*Change of Control*)

---

If the Participant is a US taxpayer, Vested Shares must be allocated, cash payments must be made in lieu of an allocation of Shares, payments must be made in respect of Vested Units and Cash Amounts must be paid, as applicable, in compliance with Section 409A to the extent applicable.

The Rules of **Part C** Section 13 (*Power to adjust Rights, Options and/or Units and the Exercise Price*)

---

With respect to an Option granted to a US taxpayer, the Exercise Price must be not less than the fair market value of the Shares on the date of grant, to the extent required by Section 409A.

The Rules of **Part C** Section 16 (*Withholding*)

---

In addition, the Company shall withhold from any amounts payable under these Rules to a US taxpayer such federal, state, local or foreign taxes as shall be required to be withheld pursuant to any applicable law or regulation.

The Rules of **Part C** Section 17 (*Amendments*)

---

**17.1 Power to make amendments**

Any amendment to the Rules or plan, as applicable, will comply with the requirements under Section 409A to the extent applicable.

The Rules of **Part C** Section 20 (*Miscellaneous*)

---

**20.12 Tax**

In addition, it is intended that these Rules shall be exempt from or comply with the provisions of Section 409A so as not to subject any US taxpayer to the payment of additional taxes and interest under Section 409A. In furtherance of this intent, these Rules shall be interpreted, operated, and administered in a manner consistent with these intentions, and to the extent that any rules, regulations or other guidance issued under Section 409A would result in a US taxpayer being subject to payment of additional income taxes or interest under Section 409A, the Board may amend these Rules in order to avoid the application of such taxes or interest to the extent permitted by Section 409A.

Notwithstanding any provision to the contrary in these Rules, no payment or distribution under these Rules which constitutes deferred compensation under Section 409A and becomes payable by reason of a US taxpayer's termination of employment within the Group will be made to such US taxpayer unless the US taxpayer's termination of employment constitutes a "separation from service" (as such term is defined in Treasury Regulations issued under Section 409A). For the purposes of these Rules, each amount to be paid or benefit to be provided shall be construed as a separate identified payment for the purposes of Section 409A. In no event may a Participant who is a US taxpayer, directly or indirectly, designate the calendar year of payment. Notwithstanding any provision of these Rules to the contrary, if necessary to comply with the restriction in Section 409A(a)(2)(B) of the Code concerning payments to "specified employees" (as defined in Section 409A) any payment on account of a Participant's separation from service that would otherwise be due hereunder within six months after such separation will nonetheless be delayed until the first business day of the seventh month following the Participant's date of termination (or, if earlier, the Participant's death) and the first such payment will include the cumulative amount of any payments that would have been paid prior to such date if not for such restriction.

The Rules of **Part D** Section 21.1 (*Definitions*)

---

**21.1 Definitions**

**Change of Control Event** - with respect to any award that constitutes a deferral of compensation subject to Section 409A, a change in the ownership or effective control of the Company or in the ownership of a substantial portion of the assets of the Company under Section 409A(a)(2)(A)(v) of the Code and regulations thereunder.

All references in these Rules to a "change in the Control of the Company" or to a "change of Control" or to a company "obtain[ing] Control" shall be construed in accordance with Section 409A(a)(2)(A)(v) of the Code to the extent applicable.

**Provisions applicable to International Participants**

---

This Addendum 2 contains certain rules and definitions that apply to any Participant that:

- (i) is not resident in Australia; and
  - (ii) is not subject to the United States taxation in accordance with Addendum 1,
- (an “**International Participant**”).

The terms and conditions set out in this Addendum 2 apply to such International Participants, and as indicated in this Addendum 2, certain terms and conditions of these Rules will not apply to such International Participants.

In the case of any conflict between the terms of these Rules and the terms of this Addendum 2 with respect to International Participants, the terms of this Addendum 2 will prevail.

**The Rules of Part C Section 7 (*Prohibited Dealings*)**

---

Rule 7(a) is amended to read: “Any Dealing in respect of an Incentive Security prior to Vesting is prohibited. For the avoidance of doubt, this Rule 7(a) does not restrict the transmission of an Incentive Security to the Participant’s personal representatives following their death.”

**The Rules of Part C Section 20.2 (*Rights and obligations of Participants*)**

---

A new Rule 20.2(j) and 20.2(k) is added to Rule 20.2 as follows:

- (j) Benefits under the Rules do not form part of a Participant’s remuneration for any purpose and are not pensionable.
- (k) By participating in the Plan, the Participant waives all and any rights to compensation or damages in consequence of the termination of his office or employment with any past or present Group company for any reason whatsoever, whether lawfully or otherwise, insofar as those rights arise or may arise from his ceasing to have rights under the Rules (including ceasing to be entitled to exercise any Option) as a result of such termination, or from the loss or diminution in value of such rights or entitlements, including by reason of the operation of the Rules, any determination by the Board pursuant to a discretion contained in the Rules or the provisions of any statute or law relating to taxation.

**The Rules of Part D Section 21.1 (*Definitions*)**

---

The definition of **Eligible Employee** in Rule 21.1 is amended to read: “an employee of the Group (including a Director employed in an executive capacity).”

## List of Subsidiaries

#	Company Name	Country
	<b>Wholly owned subsidiaries</b>	
1.	141 Union Company	United States of America
2.	ACG Mineracao Ltda	Brazil
3.	Agnew Pastoral Company Pty Ltd	Australia
4.	Albion Downs Pty Limited	Australia
5.	Araguaia Participações Ltda	Brazil
6.	ARL Holdings Ltd (in liquidation)	Bermuda
7.	ARL South America Exploration Ltd (in liquidation)	Bermuda
8.	Avanco Holdings Pty Ltd <sup>(a)</sup>	Australia
9.	Avanco Lux S.ar.l	Luxembourg
10.	Avanco Lux S.C.S.	Avanco Lux S.C.S.
11.	Avanco Resources Mineração Ltda	Brazil
12.	Avanco Resources Pty Ltd <sup>(a)(b)</sup>	Australia
13.	AVB Brazil Pty Ltd	Australia
14.	AVB Carajás Holdings Pty Ltd	Australia
15.	AVB Copper Pty Ltd	Australia
16.	AVB Mineração Ltda	Brazil
17.	AVB Minerals Pty Ltd	Australia
18.	BHP (AUS) DDS Pty Ltd	Australia
19.	BHP (Towage Services) Pty Ltd <sup>(a)(b)</sup>	Australia
20.	BHP Aluminum Australia Pty Ltd	Australia
21.	BHP Billiton (UK) DDS Limited	United Kingdom
22.	BHP Billiton (UK) Limited	United Kingdom
23.	BHP Billiton Brasil Ltda	Brazil
24.	BHP Billiton Company B.V.	Netherlands
25.	BHP Billiton Finance (USA) Limited	Australia
26.	BHP Billiton Finance B.V.	Netherlands
27.	BHP Billiton Finance Limited	Australia
28.	BHP Billiton Finance Plc	United Kingdom
29.	BHP Billiton Freight Singapore Pte Limited	Singapore
30.	BHP Billiton Group Limited	United Kingdom
31.	BHP Billiton Holdings Limited	United Kingdom
32.	BHP Billiton International Metals B.V.	Netherlands
33.	BHP Billiton International Services Limited	United Kingdom
34.	BHP Billiton International Trading (Shanghai) Co. Ltd	China
35.	BHP Billiton Marketing AG	Switzerland
36.	BHP Billiton Marketing Asia Pte Ltd	Singapore
37.	BHP Billiton Marketing UK Limited	United Kingdom
38.	BHP Billiton Petroleum Great Britain Limited	United Kingdom
39.	BHP Billiton Services Jersey Limited	Jersey
40.	BHP Billiton SSM Development Pty Ltd	Australia
41.	BHP Billiton Sustainable Communities	United Kingdom
42.	BHP Billiton UK Holdings Limited	British Virgin Islands
43.	BHP Billiton UK Investments Limited	British Virgin Islands
44.	BHP BK Limited	United Kingdom
45.	BHP Canada Inc.	Canada
46.	BHP Capital No. 20 Pty Limited	Australia
47.	BHP Chile Inc.	United States of America
48.	BHP Chile Inversiones Limitada	Chile

49.	BHP Coal Pty Ltd <sup>(a)(b)</sup>	Australia
50.	BHP Copper Inc.	United States of America
51.	BHP Direct Reduced Iron Pty Limited <sup>(a)</sup>	Australia
52.	BHP Energy Coal Australia Pty Ltd	Australia
53.	BHP Escondida Inc.	United States of America
54.	BHP Exploration Chile SpA	Chile
55.	BHP Finance (International) Inc.	United States of America
56.	BHP Finance Limited	United Kingdom
57.	BHP Foreign Holdings Inc.	United States of America
58.	BHP Foundation	United States of America
59.	BHP Freight Pty Ltd <sup>(a)</sup>	Australia
60.	BHP Group (UK) Ltd	United Kingdom
61.	BHP Group Holdings Limited	United Kingdom
62.	BHP Group Operations Pty Ltd <sup>(a)(b)</sup>	Australia
63.	BHP Holdings (International) Inc.	United States of America
64.	BHP Holdings (USA) Inc.	United States of America
65.	BHP Holdings International (Investments) Inc.	United States of America
66.	BHP Holdings Limited	United Kingdom
67.	BHP Innovation Pty Ltd <sup>(a)</sup>	Australia
68.	BHP Internacional Participações Ltda	Brazil
69.	BHP International Finance Corp	United States of America
70.	BHP International Services Limited	United Kingdom
71.	BHP Investments Canada Inc	Canada
72.	BHP IO Mining Pty Ltd	Australia
73.	BHP IO Workshop Pty Ltd	Australia
74.	BHP Iron Ore Holdings Pty Ltd	Australia
75.	BHP Iron Ore Pty Ltd <sup>(a)(b)</sup>	Australia
76.	BHP Japan Limited	Japan
77.	BHP Lonsdale Investments Pty Ltd <sup>(a)</sup>	Australia
78.	BHP Manganese Australia Pty Ltd	Australia
79.	BHP Marine & General Insurances Pty Ltd	Australia
80.	BHP Marketing North America Inc.	United States of America
81.	BHP Marketing Services India Pvt Ltd	India
82.	BHP Marketing UK Limited	United Kingdom
83.	BHP Metals Exploration d.o.o. Beograd	Serbia
84.	BHP Metals Exploration Pty Ltd	Australia
85.	BHP MetCoal Holdings Pty Ltd <sup>(a)(b)</sup>	Australia
86.	BHP Midgard AB	Sweden
87.	BHP Mineral Resources Inc.	United States of America
88.	BHP Minerals (Shanghai) Co., Ltd	China
89.	BHP Minerals Europe Limited	United Kingdom
90.	BHP Minerals Exploration Inc.	United States of America
91.	BHP Minerals Holdings Proprietary Limited <sup>(a)(b)</sup>	Australia
92.	BHP Minerals India Private Limited	India
93.	BHP Minerals International Exploration Inc.	United States of America
94.	BHP Minerals International LLC	United States of America
95.	BHP Minerals Pty Ltd <sup>(a)(b)</sup>	Australia
96.	BHP Minerals Service Company	United States of America
97.	BHP New Mexico Coal Inc.	United States of America
98.	BHP Nickel Operations Pty Ltd	Australia
99.	BHP Nickel West Pty Ltd <sup>(a)(b)</sup>	Australia
100.	BHP Olympic Dam Corporation Pty Ltd <sup>(a)(b)</sup>	Australia
101.	BHP Peru Holdings Inc.	United States of America
102.	BHP Pty Ltd	Australia
103.	BHP Queensland Coal Investments Pty Ltd	Australia
104.	BHP Queensland Coal Limited	United States of America

105. BHP Resolution Holdings LLC	United States of America
106. BHP Shared Business Services Pty Ltd	Australia
107. BHP Shared Services Malaysia Sdn. Bhd.	Malaysia
108. BHP SSM Indonesia Holdings Pty Ltd	Australia
109. BHP SSM International Pty Ltd	Australia
110. BHP Titanium Minerals Pty Ltd	Australia
111. BHP Towage Services (Boodarie) Pty Ltd	Australia
112. BHP Towage Services (Iron Brolga) Pty Ltd	Australia
113. BHP Towage Services (Iron Corella) Pty Ltd	Australia
114. BHP Towage Services (Iron Ibis) Pty Ltd	Australia
115. BHP Towage Services (Iron Kestrel) Pty Ltd	Australia
116. BHP Towage Services (Iron Osprey) Pty Ltd	Australia
117. BHP Towage Services (Iron Quail) Pty Ltd	Australia
118. BHP Towage Services (Iron Robin) Pty Ltd	Australia
119. BHP Towage Services (Iron Whistler) Pty Ltd	Australia
120. BHP Towage Services (Iron Wren) Pty Ltd	Australia
121. BHP Towage Services (Mallina) Pty Ltd	Australia
122. BHP Towage Services (RT Atlantis) Pty Ltd	Australia
123. BHP Towage Services (RT Clerke) Pty Ltd	Australia
124. BHP Towage Services (RT Darwin) Pty Ltd	Australia
125. BHP Towage Services (RT Discovery) Pty Ltd	Australia
126. BHP Towage Services (RT Endeavour) Pty Ltd	Australia
127. BHP Towage Services (RT Enterprise) Pty Ltd	Australia
128. BHP Towage Services (RT Imperieuse) Pty Ltd	Australia
129. BHP Towage Services (RT Inspiration) Pty Ltd	Australia
130. BHP Towage Services (RT Tough) Pty Ltd	Australia
131. BHP Ventures US Inc	United States
132. BHP WAIO Pty Ltd <sup>(a)(b)</sup>	Australia
133. BHP Western Mining Resources International Pty Ltd	Australia
134. BHP World Exploration Inc.	Canada
135. BHP Yakabindie Nickel Pty Ltd <sup>(a)(b)</sup>	Australia
136. Billiton Australia Finance Pty Ltd	Australia
137. Billiton Development B.V.	Netherlands
138. Billiton Executive Pension Scheme Trustee Limited	United Kingdom
139. Billiton Guinea B.V.	Netherlands
140. Billiton Investment 3 B.V. (in liquidation)	Netherlands
141. Billiton Investment 8 B.V. (in liquidation)	Netherlands
142. Billiton Investments Ireland Limited	Ireland
143. Billiton Marketing Holding B.V.	Netherlands
144. Billiton Suriname Holdings B.V. (in liquidation)	Netherlands
145. Broadmeadow Mine Services Pty Ltd <sup>(a)</sup>	Australia
146. Carrapateena Pty Ltd <sup>(a)(b)</sup>	Australia
147. Carson Hill Gold Mining Corporation	United States of America
148. Cassini Resources Pty Ltd	Australia
149. Central Queensland Services Pty Ltd <sup>(a)</sup>	Australia
150. Cerro-Quebrado S.A.	Ecuador
151. Coal Mines Australia Pty Ltd	Australia
152. Compañía Minera Cerro Colorado Limitada	Chile
153. Consolidated Nominees Proprietary Limited	South Africa
154. Crossbow Resources Pty Ltd	Australia
155. CTP Assets Pty Ltd	Australia
156. CTP Operations Pty Ltd	Australia
157. Estrela Metals Pty Ltd	Australia
158. Global BHP Copper Ltd	Cayman Islands
159. Hay Point Services Pty Limited <sup>(a)</sup>	Australia



160. Hunter Valley Energy Coal Pty Ltd	Australia
161. Jenipapo Recursos Naturais Ltda	Brazil
162. Marcona International S.A.	Panama
163. MCT Mineração Ltda	Brazil
164. Mineração Águas Boas Ltda	Brazil
165. Minera Spence SA	Chile
166. Minotaur Resources Holdings Pty Ltd <sup>(a)(b)</sup>	Australia
167. Mt Arthur Coal Pty Limited	Australia
168. Mt Arthur Underground Pty Ltd	Australia
169. Operation Services Chile SpA	Chile
170. OS ACPM Pty Ltd <sup>(a)(b)</sup>	Australia
171. OS MCAP Pty Ltd <sup>(a)(b)</sup>	Australia
172. OZ Exploration Pty Ltd	Australia
173. OZ Minerals Pty Ltd <sup>(a)(b)</sup>	Australia
174. OZ Minerals Brazil (Holdings) Pty Ltd <sup>(a)(b)</sup>	Australia
175. OZ Minerals Carrapateena Pty Ltd <sup>(a)(b)</sup>	Australia
176. OZ Minerals Equity Pty Ltd	Australia
177. OZ Minerals Group Treasury Pty Ltd	Australia
178. OZ Minerals Holdings Pty Ltd	Australia
179. OZ Minerals Insurance Pte Ltd	Singapore
180. OZ Minerals International (Holdings) Pty Ltd	Australia
181. OZ Minerals Investments Pty Ltd	Australia
182. OZ Minerals Jamaica Limited (in liquidation)	Jamaica
183. OZ Minerals Musgrave Holdings Pty Ltd <sup>(a)</sup>	Australia
184. OZ Minerals Musgrave Operations Pty Ltd <sup>(a)</sup>	Australia
185. OZ Minerals Peru S.A.C. (in liquidation)	Peru
186. OZ Minerals Prominent Hill Operations Pty Ltd <sup>(a)(b)</sup>	Australia
187. OZ Minerals Prominent Hill Pty Ltd <sup>(a)(b)</sup>	Australia
188. OZ Minerals Services Pty Ltd	Australia
189. OZ Minerals Zinifex Holdings Pty Ltd	Australia
190. OZM Carrapateena Pty Ltd <sup>(a)</sup>	Australia
191. Phoenix Mining Finance Company Proprietary Limited (in liquidation)	South Africa
192. Pilbara Gas Pty Limited <sup>(a)</sup>	Australia
193. Pilbara Pastoral Company Pty Limited	Australia
194. PT Billiton Indonesia	Indonesia
195. RAL Cayman Inc.	Cayman Islands
196. Rio Algom Exploration Inc.	Canada
197. Rio Algom Investments (Chile) Inc.	Canada
198. Rio Algom Limited	Canada
199. Rio Algom Mining LLC	United States of America
200. Riocerro Inc.	Cayman Islands
201. Riochile Inc.	Cayman Islands
202. SLM Santa Lucia Mineração Eireli	Brazil
203. Stein Insurance Company Limited	Guernsey
204. Tamakaya Energia SpA	Chile
205. The Broken Hill Proprietary Company Pty Ltd <sup>(a)(b)</sup>	Australia
206. UMAL Consolidated Pty Ltd <sup>(a)(b)</sup>	Australia
207. United Iron Pty Ltd	Australia
208. Westminer Insurance Pte Ltd	Singapore
209. Wirraway Metals & Mining Pty Ltd	Australia
210. WMC Corporate Services Inc.	United States of America
211. WMC Finance (USA) Limited	Australia
212. WMC Mineracao Ltda.	Brazil
213. ZRUS Holdings Pty Ltd	Australia

**Subsidiaries where effective interest is less than 100 per cent**

214. BHP Billiton (Philippines) Inc. (99.99%)	Philippines
215. BHP Iron Ore (Jimblebar) Pty Ltd (85%)	Australia
216. BHP Shared Services Philippines Inc. (99.99%)	Philippines
217. Consórcio Santos Luz de Imóveis Ltda (90%)	Brazil
218. Kelti S.A. (57.5%)	Chile
219. Minera Escondida Ltda (57.5%)	Chile
220. QNI Philippines Inc. (99.99%)	Philippines

**221. Joint operations**

Mt Goldsworthy (85%)	Australia
222. Mt Newman (85%)	Australia
223. Yandi (85%)	Australia
224. Central Queensland Coal Associates (50%)	Australia
225. BHP SaskPower Carbon Capture and Storage (CCS) Knowledge Centre Inc. (50%)	Canada
226. BM Alliance Coal Marketing Pty Limited (50%)	Australia
227. BM Alliance Coal Operations Pty Limited (50%)	Australia
228. BM Alliance Marketing Pte Ltd (50%)	Singapore
229. BMA Japan KK (50%)	Japan

**230. Joint ventures and associates**

CMC-Coal Marketing DAC (33.33%)	Ireland
231. Compañía Minera Antamina S.A. (33.75%)	Peru
232. Global HubCo B.V. (33.33%)	Netherlands
233. NCIG Holdings Pty Ltd (27.98%)	Australia
234. Resolution Copper Mining LLC (45%)	United States of America
235. RightShip Pty Limited (33.33%)	Australia
236. Samarco Mineração S.A. (50%)	Brazil

(a) These companies are parties to the Limited Deed of Cross Guarantee (Deed) and members of the Closed Group as at 30 June 2024.

(b) These companies are parties to the Deed and are relieved from the Corporations Act 2001 requirements for preparation, audit and lodgement of financial reports and Directors' reports.



## Securities Dealing policy

### Brief description

This document describes BHP's Securities Dealing controls and processes designed to prevent the misuse (or perceived misuse) of sensitive information by restricting certain securities dealings by BHP directors, employees and contractors.

Effective 5 March 2018

For personal use only

## **BHP: Securities Dealing policy**

### **Securities Dealing policy**

#### **1. Background**

BHP has developed controls and processes designed to prevent the misuse (or perceived misuse) of sensitive information by restricting certain Securities Dealings by BHP directors, employees and contractors.

This policy is intended to assist BHP directors, employees and contractors to comply with their legal obligations relating to Securities Dealings.

Compliance with insider trading laws and this Securities Dealing policy is each individual's responsibility. Breach of this policy will be regarded by BHP as serious misconduct which may lead to disciplinary action including dismissal.

For further information on this policy or any questions on how this policy applies to a proposed Dealing, please contact Group Governance.

Attachment 1 sets out the defined terms which are identified by the use of capital letters.

#### **2. To whom does this policy apply?**

Certain obligations detailed in this policy apply to all BHP directors, employees and contractors.

Certain additional restrictions detailed in this policy apply only to:

- participants in BHP's employee incentive schemes;
- Restricted Persons; and
- persons discharging managerial responsibilities (PDMRs).

#### **3. Dealing restrictions**

##### **All BHP directors, employees and contractors**

##### **Insider trading**

##### *BHP Securities*

BHP directors, employees and contractors who have Inside Information about BHP must not:

- Deal in BHP Securities;
- advise, procure or encourage another person to Deal in BHP Securities; or
- pass on Inside Information to any other person (whether directly or indirectly), if the BHP director, employee or contractor knows or ought reasonably to know that the other person may use the information to Deal (or advise, procure or encourage someone else to Deal) in BHP Securities.

Participation in any of the activities listed above is called 'insider trading'.

The purpose or motive for the Dealing, or whether a profit is made from the Dealing, is irrelevant.

## **BHP: Securities Dealing policy**

### *Insider lists*

Group Governance will maintain BHP insider lists and will notify people recorded on any insider list. People on an insider list are considered to have Inside Information and accordingly, the prohibitions set out above will apply.

### *Other entities*

The prohibition on insider trading is not restricted to dealings in BHP Securities. BHP directors, employees and contractors who have Inside Information relating to an external company must not Deal in the Securities of that company.

### *Consequences*

Compliance with insider trading laws and this Securities Dealing policy is an individual's responsibility. Breach of this policy will be regarded by BHP as serious misconduct which may lead to disciplinary action, including dismissal. The penalties for breach of the insider trading prohibitions include potential criminal liability.

## **Confidential information**

BHP directors, employees and contractors are bound by a duty of confidentiality in relation to confidential information obtained directly or indirectly in the course of their duties.

BHP directors, employees and contractors must not communicate any confidential information concerning BHP, or use that information in any way, to gain an advantage for themselves or to injure or cause loss to BHP.

## **BHP's reputation**

It is of fundamental importance that public confidence in BHP is maintained. It could be damaging to BHP's reputation if the market or the general public perceived that directors, employees or contractors might be taking advantage of their position in BHP to make financial gains (for example, by dealing in Securities on the basis of Inside Information).

As a guiding principle, BHP directors, employees and contractors should ask themselves:

*If the market was aware of all the current circumstances, could the proposed dealing be perceived as taking advantage of my position in an inappropriate way? How would it look if the transaction were reported on the front page of the newspaper?*

If a BHP director, employee or contractor is unsure, they should consult Group Governance.

Where clearance is required for a Dealing under this policy, clearance will not be granted where the Dealing would not satisfy the considerations above.

## **Participants in BHP's employee incentive schemes**

BHP employees who are participants in BHP's Group Incentive Scheme, Long Term Incentive Plan, the Management Award Plan, the Group Short Term Incentive Plan, or any successor to these plans, must not Deal in any BHP Securities during any Closed Period.

Participants must not at any time enter into a transaction that operates or is intended to operate to limit participants' exposure to the risk of holdings of unvested BHP Securities granted under a BHP employee incentive scheme or vested BHP Securities that are subject to holding locks or similar restrictions.

## **Restricted Persons**

Restricted Persons are subject to additional Dealing restrictions.

## **BHP: Securities Dealing policy**

Group Governance will notify people if they are Restricted Persons recorded on the Securities Dealing Restricted List.

Restricted Persons are people who regularly have access to sensitive BHP information due to their position within the Group. Restricted Persons include (but are not limited to):

- Executive Leadership Team members who are not PDMRs;
- assistants and managers to Executive Leadership Team members;
- Investor Relations employees;
- Group Governance employees;
- Asset Presidents; and
- key employees in Corporate Affairs and Group Reporting.

Restricted Persons must not Deal in BHP Securities:

- during any Closed Period; or
- without prior clearance using the Securities Dealing Clearance Request Form (see the “Clearance Procedures” section of this policy).

### **Persons discharging managerial responsibilities (PDMRs)**

PDMRs are subject to additional Dealing restrictions. PDMRs must not Deal (or Deal on behalf of a third party) in any BHP Securities:

- during a Closed Period; or
- without prior notification to the Group Company Secretary and clearance using the Securities Dealing Clearance Request Form (see the “Clearance Procedures” section of this policy).

PDMRs are prohibited from Dealing in any BHP Securities:

- on considerations of a short-term nature. An investment with a maturity of one year or less will always be considered to be of a short-term nature; and
- where the Dealing involves using unvested BHP Securities as collateral in any financial transaction, including hedging and margin loan arrangements.

After Dealing in BHP Securities, PDMRs must notify the Group Company Secretary of the transaction details. Dealings by PDMRs are required to be notified to stock exchanges and the UK Financial Conduct Authority within three business days after the Dealing. Subject to authorisation by the PDMR, BHP will make this notification on the PDMR's behalf.

Certain obligations also apply in respect of persons closely associated (PCAs) with PDMRs. Those obligations are outlined below.

PDMRs must notify each of their PCAs of the restrictions and disclosure requirements in relation to Dealings in BHP Securities and receive acknowledgement from the PCA that they understand their obligations.

PDMRs must notify their PCAs that:

- they are a PCA and that obligations arise as a result of their relationship with a BHP PDMR;
- they must not Deal in BHP Securities during a Closed Period;
- they must advise the Group Company Secretary of the transaction details immediately after they have Dealt in BHP Securities; and

## **BHP: Securities Dealing policy**

- Dealings by PCAs are required to be notified to the stock exchanges and to the UK Financial Conduct Authority within three Business Days after the Dealing. Subject to authorisation by the PCA, BHP can file these notifications on the PCA's behalf.

BHP maintains a record of all PCAs notified by its PDMRs.

### **4. Clearance procedures**

#### **Timing requirements**

Clearance Officers must give the person making the Dealing request a copy of the response and clearance (if any) in writing within two Business Days after the initial clearance request. Group Governance will maintain a record of the response to any Dealing request and of any clearance given.

If clearance is given, the Dealing must be completed within two Business Days thereafter.

#### **Dealings in exceptional circumstances**

Clearance may be given to a PDMR or Restricted Person to Deal on his or her own account, or for the account of a third party, during a Closed Period if they are not in possession of Inside Information in relation to BHP and either:

- exceptional circumstances, such as severe financial difficulty or compulsion by court order, exist which require the immediate sale of shares; or
- the Dealing is made under, or related to, an employee share or saving scheme, qualification or entitlement of shares; or
- the Dealing does not result in a change to the beneficial interest in the Securities.

The determination of whether the person in question is in severe financial difficulty or whether there are other exceptional circumstances can be made only by the Group Company Secretary or by the Chairman of the Board.

#### **Excluded Dealings**

Other than during the period of 30 days prior to the announcement of BHP's full year results and the period of 30 days prior to the publication of BHP's half year results, clearance is not required for:

- the following categories of Dealings:
  - acquisition of BHP Securities through a dividend reinvestment plan;
  - acquisition of BHP Securities through a share purchase plan available to all retail shareholders;
  - acquisition of BHP Securities through a rights issue; and
  - the disposal of BHP Securities through the acceptance of a takeover offer, scheme of arrangement or equal access buy-back; and
- Dealings that result in no effective change to the beneficial interest in the BHP Securities (for example, transfers of BHP Securities already held in a superannuation fund or trust of which the director, employee, contractor or PCA is a beneficiary).

However, such Dealings remain subject to the prohibitions on insider trading under relevant laws and regulations.

## **BHP: Securities Dealing policy**

### **Other matters**

Any clearance to Deal can be given or refused by a Clearance Officer at his or her discretion. No clearance to Deal will be given if the Dealing would breach the prohibitions on insider trading under relevant law or regulation.

This decision to refuse clearance is final and binding. If clearance is refused, the person seeking the clearance must keep that information confidential and not disclose it to anyone

A clearance to Deal can be withdrawn if new information comes to light or there is a change in circumstances.

Any clearance to Deal is not an endorsement of the proposed Dealing. The person doing the Dealing is individually responsible for their investment decisions and their compliance with insider trading and market abuse laws.

If a person comes into possession of Inside Information after receiving clearance, they must not deal despite having received clearance.

### **5. Compliance**

Strict compliance with this policy is mandatory.

For personal use



**BHP: Securities Dealing policy****Attachment: Definitions**

<b>Term</b>	<b>Definition</b>
<b>Business Day Business Days</b>	Any day which is not a Saturday, Sunday, Christmas Day, Good Friday, a bank holiday in the United Kingdom or a public holiday in Australia.
<b>BHP</b>	BHP Billiton Limited, BHP Billiton Plc and its related bodies corporate.
<b>Clearance Officer</b>	Any of the following: <ul style="list-style-type: none"><li>• Group Company Secretary;</li><li>• Vice President, Group Governance;</li><li>• Head of Governance RAC &amp; Disclosure; or</li><li>• Head of ESG Policy &amp; Engagement.</li></ul>
<b>Closed Period</b>	The period from: <ul style="list-style-type: none"><li>• the end of BHP's financial year to the publication of BHP's full year results announcement; and</li><li>• the end of BHP's half year to the publication of BHP's half year results.</li></ul>
<b>Deal Dealing Dealings Dealt</b>	Includes, in relation to Securities, any transaction or change affecting title to or interest in Securities, including: <ul style="list-style-type: none"><li>• any acquisition or disposal, or agreement to acquire or dispose;</li><li>• entering into a contract to secure a profit or avoid a loss by reference to price fluctuations;</li><li>• grant, acceptance, acquisition, disposal, exercise or discharge of any option;</li><li>• entering, terminating, assigning or novating any stock lending agreement;</li><li>• using as security, or otherwise granting a charge, lien or other encumbrance;</li><li>• any transaction, or the exercise of any power or discretion, effecting a change of ownership of a beneficial interest; and</li><li>• any other right or obligation, present or future, conditional or unconditional, to acquire or dispose.</li></ul>
<b>Group Governance</b>	BHP's Group Governance function.

**BHP: Securities Dealing policy**

<b>Term</b>	<b>Definition</b>
<b>Inside Information</b>	<p>Information which:</p> <ul style="list-style-type: none"><li>• is not generally available; and</li><li>• if made generally available, would be likely or expected to have a significant or material effect on the price or value of BHP's or another company's Securities (judged by whether it would affect a reasonable investor's investment decision).</li></ul> <p>Such information may include matters of supposition, matters insufficiently definite to warrant being made public and matters relating to the intentions, or likely intentions, of a person.</p>
<b>Person closely associated (PCA)</b>	<p>A person closely associated with a PDMR, being:</p> <ul style="list-style-type: none"><li>• family members (spouse, civil partner, dependent children/stepchildren and relatives who have shared the same household for at least one year), and</li><li>• companies, trusts, partnerships or entities:<ul style="list-style-type: none"><li>• which are managed by a PDMR or a family member;</li><li>• which are directly or indirectly controlled by a PDMR or a family member;</li><li>• which are set up for the benefit of a PDMR or a family member; or</li><li>• the economic interests of which are substantially equivalent to a PDMR's or a family member's.</li></ul></li></ul>
<b>Person discharging managerial responsibilities (PDMR)</b>	<ul style="list-style-type: none"><li>• a Director;</li><li>• a key management personnel named in BHP's remuneration report; or</li><li>• a person as such determined by the Group Company Secretary.</li></ul>
<b>Restricted Person</b>	A person recorded on the Securities Dealing Restricted List.
<b>Securities</b>	<p>Any publicly traded or quoted securities of any company, including any member of BHP, or any other financial products or instruments whether quoted or not and any securities that are convertible into or linked to such securities.</p> <p>Includes:</p> <ul style="list-style-type: none"><li>• shares and other securities equivalent to shares;</li><li>• options or rights to shares or other securities equivalent to shares;</li><li>• bonds and other forms of securitised debt; and</li><li>• securitised debt convertible or exchangeable into shares or into other securities equivalent to shares.</li></ul>

## SECTION 302 CERTIFICATION

## CEO Certification

I, Mike Henry, certify that:

1. I have reviewed this annual report on Form 20-F of BHP Group Limited (the “company”);
2. Based on my knowledge, this report does not contain any untrue statement of a material fact or omit to state a material fact necessary to make the statements made, in light of the circumstances under which such statements were made, not misleading with respect to the period covered by this report;
3. Based on my knowledge, the financial statements, and other financial information included in this report, fairly present in all material respects the financial condition, results of operations and cash flows of the company as of, and for, the periods presented in this report;
4. The company’s other certifying officer and I are responsible for establishing and maintaining disclosure controls and procedures (as defined in Exchange Act Rules 13a-15(e) and 15d-15(e)) and internal control over financial reporting (as defined in Exchange Act Rules 13a-15(f) and 15d-15(f)) for the company and have:
  - (a) Designed such disclosure controls and procedures, or caused such disclosure controls and procedures to be designed under our supervision, to ensure that material information relating to the company, including its consolidated subsidiaries, is made known to us by others within those entities, particularly during the period in which this report is being prepared;
  - (b) Designed such internal control over financial reporting, or caused such internal control over financial reporting to be designed under our supervision, to provide reasonable assurance regarding the reliability of financial reporting and the preparation of financial statements for external purposes in accordance with generally accepted accounting principles;
  - (c) Evaluated the effectiveness of the company’s disclosure controls and procedures and presented in this report our conclusions about the effectiveness of the disclosure controls and procedures, as of the end of the period covered by this report based on such evaluation; and
  - (d) Disclosed in this report any change in the company’s internal control over financial reporting that occurred during the period covered by the annual report that has materially affected, or is reasonably likely to materially affect, the company’s internal control over financial reporting; and
5. The company’s other certifying officer and I have disclosed, based on our most recent evaluation of internal control over financial reporting, to the company’s auditors and the audit committee of the company’s board of directors (or persons performing the equivalent functions):
  - (a) All significant deficiencies and material weaknesses in the design or operation of internal control over financial reporting which are reasonably likely to adversely affect the company’s ability to record, process, summarize and report financial information; and
  - (b) Any fraud, whether or not material, that involves management or other employees who have a significant role in the company’s internal control over financial reporting.

/s/ Mike Henry

Name: Mike Henry  
Title: Chief Executive Officer  
Date: 30 August 2024

## SECTION 302 CERTIFICATION

## CFO Certification

I, Vandita Pant, certify that:

1. I have reviewed this annual report on Form 20-F of BHP Group Limited (the “company”);
2. Based on my knowledge, this report does not contain any untrue statement of a material fact or omit to state a material fact necessary to make the statements made, in light of the circumstances under which such statements were made, not misleading with respect to the period covered by this report;
3. Based on my knowledge, the financial statements, and other financial information included in this report, fairly present in all material respects the financial condition, results of operations and cash flows of the company as of, and for, the periods presented in this report;
4. The company’s other certifying officer and I are responsible for establishing and maintaining disclosure controls and procedures (as defined in Exchange Act Rules 13a-15(e) and 15d-15(e)) and internal control over financial reporting (as defined in Exchange Act Rules 13a-15(f) and 15d-15(f)) for the company and have:
  - (a) Designed such disclosure controls and procedures, or caused such disclosure controls and procedures to be designed under our supervision, to ensure that material information relating to the company, including its consolidated subsidiaries, is made known to us by others within those entities, particularly during the period in which this report is being prepared;
  - (b) Designed such internal control over financial reporting, or caused such internal control over financial reporting to be designed under our supervision, to provide reasonable assurance regarding the reliability of financial reporting and the preparation of financial statements for external purposes in accordance with generally accepted accounting principles;
  - (c) Evaluated the effectiveness of the company’s disclosure controls and procedures and presented in this report our conclusions about the effectiveness of the disclosure controls and procedures, as of the end of the period covered by this report based on such evaluation; and
  - (d) Disclosed in this report any change in the company’s internal control over financial reporting that occurred during the period covered by the annual report that has materially affected, or is reasonably likely to materially affect, the company’s internal control over financial reporting; and
5. The company’s other certifying officer and I have disclosed, based on our most recent evaluation of internal control over financial reporting, to the company’s auditors and the audit committee of the company’s board of directors (or persons performing the equivalent functions):
  - (a) All significant deficiencies and material weaknesses in the design or operation of internal control over financial reporting which are reasonably likely to adversely affect the company’s ability to record, process, summarize and report financial information; and
  - (b) Any fraud, whether or not material, that involves management or other employees who have a significant role in the company’s internal control over financial reporting.

/s/ Vandita Pant

Name: Vandita Pant  
Title: Chief Financial Officer  
Date: 30 August 2024

**SECTION 906 CERTIFICATION**

Pursuant to section 906 of the Sarbanes-Oxley Act of 2002 (subsections (a) and (b) of section 1350, chapter 63 of title 18, United States Code) in connection with the annual report on Form 20-F of BHP Group Limited (the "Company") for the annual period ended 30 June 2024 as filed with the Securities and Exchange Commission on the date hereof (the "Report"), the undersigned officer of the Company hereby certifies, to such officer's knowledge, that:

- (1) The Report fully complies with the requirements of Section 13(a) or 15(d) of the Securities Exchange Act of 1934; and
- (2) The information contained in the Report fairly presents, in all material respects, the financial condition and results of operations of the Company.

/s/ Mike Henry

\_\_\_\_\_  
Name: Mike Henry  
Title: Chief Executive Officer  
Date: 30 August 2024

This certification accompanies the Report pursuant to § 906 of the Sarbanes-Oxley Act of 2002 and shall not, except to the extent required by the Sarbanes-Oxley Act of 2002, be deemed "filed" by the Company for purposes of §18 of the Securities Exchange Act of 1934, as amended, or otherwise subject to the liability of that section.

For personal use

**SECTION 906 CERTIFICATION**

Pursuant to section 906 of the Sarbanes-Oxley Act of 2002 (subsections (a) and (b) of section 1350, chapter 63 of title 18, United States Code) in connection with the annual report on Form 20-F of BHP Group Limited (the "Company") for the annual period ended 30 June 2024 as filed with the Securities and Exchange Commission on the date hereof (the "Report"), the undersigned officer of the Company hereby certifies, to such officer's knowledge, that:

- (1) The Report fully complies with the requirements of Section 13(a) or 15(d) of the Securities Exchange Act of 1934; and
- (2) The information contained in the Report fairly presents, in all material respects, the financial condition and results of operations of the Company.

/s/ Vandita Pant

Name: Vandita Pant  
Title: Chief Financial Officer  
Date: 30 August 2024

This certification accompanies the Report pursuant to § 906 of the Sarbanes-Oxley Act of 2002 and shall not, except to the extent required by the Sarbanes-Oxley Act of 2002, be deemed "filed" by the Company for purposes of §18 of the Securities Exchange Act of 1934, as amended, or otherwise subject to the liability of that section.

For personal use

**Consent of Independent Registered Public Accounting Firm**

We consent to the incorporation by reference in the following Registration Statements:

- (1) Registration Statement (Form F-3 No. 333-269898) of BHP Billiton Finance (USA) Limited;
- (2) Registration Statement (Form S-8 No. 333-100496) pertaining to the BHP Billiton Limited Group Incentive Scheme;
- (3) Registration Statement (Form S-8 No. 333-141531) pertaining to the BHP Billiton Limited Global Employee Share Plan;
- (4) Registration Statement (Form S-8 No. 333-160636) pertaining to the BHP Billiton Limited Executive Incentive Plan and Group Short Term Incentive Plan; and
- (5) Registration Statement (Form S-8 No. 333-227431) pertaining to the BHP Billiton Limited Executive Incentive Plan and the BHP Billiton Limited Global Employee Share Plan;

of our reports dated 30 August 2024, with respect to the consolidated financial statements of BHP Group Limited, and the effectiveness of internal control over financial reporting of BHP Group Limited included in this Annual Report (Form 20-F) of BHP Group Limited for the year ended 30 June 2024.

/s/ Ernst & Young  
Melbourne, Australia  
30 August 2024

For personal use

## CONSENT OF QUALIFIED PERSON

I, Balazs Nemeth, in connection with the annual report on Form 20-F for the year ended June 30, 2024 and any amendments or supplements and/or exhibits thereto (collectively, the "Form 20-F"), consent to:

- the filing and use of the technical report summary titled "Technical Report Summary – Jansen" (the "Technical Report Summary"), with an effective date of June 30, 2024, as an exhibit to and referenced in the Form 20-F;
- the use of and references to my name, including my status as an expert or "qualified person" (as defined in Subpart 1300 of Regulation S-K promulgated by the Securities and Exchange Commission), in connection with the Form 20-F and the Technical Report Summary;
- any extracts from, or summaries of, the Technical Report Summary in the Form 20-F and the use of information derived, summarized, quoted or referenced from the Technical Report Summary, or portions thereof, that was prepared by me, that I supervised the preparation of and/or that was reviewed and approved by me, that is included or incorporated by reference in the Form 20-F; and
- the incorporation by reference in the Registration Statements on Form S-8 (File Nos. 333-227431, 333-100496, 333-141531 and 333-160636) and Registration Statement on Form F-3 (No. 333-269898) of the above items as included in the Form 20-F.

I am responsible for authoring, and this consent pertains to, the particular section[s] identified in the Technical Report Summary as having been prepared by me and the corresponding section[s] of the Executive Summary.

Date: August 7, 2024

/s/ Balazs Nemeth

Name: Balazs Nemeth, MAusIMM

Title: Principal Geophysicist  
Jansen  
BHP



## CONSENT OF QUALIFIED PERSON

I, Cameron McKinnon, in connection with the annual report on Form 20-F for the year ended June 30, 2024 and any amendments or supplements and/or exhibits thereto (collectively, the "Form 20-F"), consent to:

- the filing and use of the technical report summary titled "Technical Report Summary – Jansen" (the "Technical Report Summary"), with an effective date of June 30, 2024, as an exhibit to and referenced in the Form 20-F;
- the use of and references to my name, including my status as an expert or "qualified person" (as defined in Subpart 1300 of Regulation S-K promulgated by the Securities and Exchange Commission), in connection with the Form 20-F and the Technical Report Summary;
- any extracts from, or summaries of, the Technical Report Summary in the Form 20-F and the use of information derived, summarized, quoted or referenced from the Technical Report Summary, or portions thereof, that was prepared by me, that I supervised the preparation of and/or that was reviewed and approved by me, that is included or incorporated by reference in the Form 20-F; and
- the incorporation by reference in the Registration Statements on Form S-8 (File Nos. 333-227431, 333-100496, 333-141531 and 333-160636) and Registration Statement on Form F-3 (No. 333-269898) of the above items as included in the Form 20-F.

I am responsible for authoring, and this consent pertains to, the particular section[s] identified in the Technical Report Summary as having been prepared by me and the corresponding section[s] of the Executive Summary.

Date: August 7, 2024

/s/ Cameron McKinnon

Name: Cameron McKinnon, APEGS

Title: Manager Process Engineering  
Jansen  
BHP

## CONSENT OF QUALIFIED PERSON

I, Graham Reynolds, in connection with the annual report on Form 20-F for the year ended June 30, 2024 and any amendments or supplements and/or exhibits thereto (collectively, the "Form 20-F"), consent to:

- the filing and use of the technical report summary titled "Technical Report Summary – Jansen" (the "Technical Report Summary"), with an effective date of June 30, 2024, as an exhibit to and referenced in the Form 20-F;
- the use of and references to my name, including my status as an expert or "qualified person" (as defined in Subpart 1300 of Regulation S-K promulgated by the Securities and Exchange Commission), in connection with the Form 20-F and the Technical Report Summary;
- any extracts from, or summaries of, the Technical Report Summary in the Form 20-F and the use of information derived, summarized, quoted or referenced from the Technical Report Summary, or portions thereof, that was prepared by me, that I supervised the preparation of and/or that was reviewed and approved by me, that is included or incorporated by reference in the Form 20-F; and
- the incorporation by reference in the Registration Statements on Form S-8 (File Nos. 333-227431, 333-100496, 333-141531 and 333-160636) and Registration Statement on Form F-3 (No. 333-269898) of the above items as included in the Form 20-F.

I am responsible for authoring, and this consent pertains to, the particular section[s] identified in the Technical Report Summary as having been prepared by me and the corresponding section[s] of the Executive Summary.

Date: August 7, 2024

/s/ Graham Reynolds

Name: Graham Reynolds, MAusIMM

Title: General Manager Operational Readiness  
Jansen  
BHP

## CONSENT OF QUALIFIED PERSON

I, Jairo Gomez, in connection with the annual report on Form 20-F for the year ended June 30, 2024 and any amendments or supplements and/or exhibits thereto (collectively, the "Form 20-F"), consent to:

- the filing and use of the technical report summary titled "Technical Report Summary – Jansen" (the "Technical Report Summary"), with an effective date of June 30, 2024, as an exhibit to and referenced in the Form 20-F;
- the use of and references to my name, including my status as an expert or "qualified person" (as defined in Subpart 1300 of Regulation S-K promulgated by the Securities and Exchange Commission), in connection with the Form 20-F and the Technical Report Summary;
- any extracts from, or summaries of, the Technical Report Summary in the Form 20-F and the use of information derived, summarized, quoted or referenced from the Technical Report Summary, or portions thereof, that was prepared by me, that I supervised the preparation of and/or that was reviewed and approved by me, that is included or incorporated by reference in the Form 20-F; and
- the incorporation by reference in the Registration Statements on Form S-8 (File Nos. 333-227431, 333-100496, 333-141531 and 333-160636) and Registration Statement on Form F-3 (No. 333-269898) of the above items as included in the Form 20-F.

I am responsible for authoring, and this consent pertains to, the particular section[s] identified in the Technical Report Summary as having been prepared by me and the corresponding section[s] of the Executive Summary.

Date: August 7, 2024

/s/ Jairo Gomez

Name: Jairo Gomez, APEGS

Title: Principal Geotechnical Engineer  
Jansen  
BHP

## CONSENT OF QUALIFIED PERSON

I, Jessica Perras, in connection with the annual report on Form 20-F for the year ended June 30, 2024 and any amendments or supplements and/or exhibits thereto (collectively, the "Form 20-F"), consent to:

- the filing and use of the technical report summary titled "Technical Report Summary – Jansen" (the "Technical Report Summary"), with an effective date of June 30, 2024, as an exhibit to and referenced in the Form 20-F;
- the use of and references to my name, including my status as an expert or "qualified person" (as defined in Subpart 1300 of Regulation S-K promulgated by the Securities and Exchange Commission), in connection with the Form 20-F and the Technical Report Summary;
- any extracts from, or summaries of, the Technical Report Summary in the Form 20-F and the use of information derived, summarized, quoted or referenced from the Technical Report Summary, or portions thereof, that was prepared by me, that I supervised the preparation of and/or that was reviewed and approved by me, that is included or incorporated by reference in the Form 20-F; and
- the incorporation by reference in the Registration Statements on Form S-8 (File Nos. 333-227431, 333-100496, 333-141531 and 333-160636) and Registration Statement on Form F-3 (No. 333-269898) of the above items as included in the Form 20-F.

I am responsible for authoring, and this consent pertains to, the particular section[s] identified in the Technical Report Summary as having been prepared by me and the corresponding section[s] of the Executive Summary.

Date: August 14, 2024

/s/ Jessica Perras

Name: Jessica Perras, APEGS

Title: Tailings & Closure Planner  
Jansen  
BHP

## CONSENT OF QUALIFIED PERSON

I, Johannes Sondergaard, in connection with the annual report on Form 20-F for the year ended June 30, 2024 and any amendments or supplements and/or exhibits thereto (collectively, the "Form 20-F"), consent to:

- the filing and use of the technical report summary titled "Technical Report Summary – Jansen" (the "Technical Report Summary"), with an effective date of June 30, 2024, as an exhibit to and referenced in the Form 20-F;
- the use of and references to my name, including my status as an expert or "qualified person" (as defined in Subpart 1300 of Regulation S-K promulgated by the Securities and Exchange Commission), in connection with the Form 20-F and the Technical Report Summary;
- any extracts from, or summaries of, the Technical Report Summary in the Form 20-F and the use of information derived, summarized, quoted or referenced from the Technical Report Summary, or portions thereof, that was prepared by me, that I supervised the preparation of and/or that was reviewed and approved by me, that is included or incorporated by reference in the Form 20-F; and
- the incorporation by reference in the Registration Statements on Form S-8 (File Nos. 333-227431, 333-100496, 333-141531 and 333-160636) and Registration Statement on Form F-3 (No. 333-269898) of the above items as included in the Form 20-F.

I am responsible for authoring, and this consent pertains to, the particular section[s] identified in the Technical Report Summary as having been prepared by me and the corresponding section[s] of the Executive Summary.

Date: August 7, 2024

/s/ Johannes Sondergaard

Name: Johannes Sondergaard, MAusIMM

Title: Manager Resource Engineering

Jansen

BHP

For personal use only

## CONSENT OF QUALIFIED PERSON

I, Melanie Failler, in connection with the annual report on Form 20-F for the year ended June 30, 2024 and any amendments or supplements and/or exhibits thereto (collectively, the "Form 20-F"), consent to:

- the filing and use of the technical report summary titled "Technical Report Summary – Jansen" (the "Technical Report Summary"), with an effective date of June 30, 2024, as an exhibit to and referenced in the Form 20-F;
- the use of and references to my name, including my status as an expert or "qualified person" (as defined in Subpart 1300 of Regulation S-K promulgated by the Securities and Exchange Commission), in connection with the Form 20-F and the Technical Report Summary;
- any extracts from, or summaries of, the Technical Report Summary in the Form 20-F and the use of information derived, summarized, quoted or referenced from the Technical Report Summary, or portions thereof, that was prepared by me, that I supervised the preparation of and/or that was reviewed and approved by me, that is included or incorporated by reference in the Form 20-F; and
- the incorporation by reference in the Registration Statements on Form S-8 (File Nos. 333-227431, 333-100496, 333-141531 and 333-160636) and Registration Statement on Form F-3 (No. 333-269898) of the above items as included in the Form 20-F.

I am responsible for authoring, and this consent pertains to, the particular section[s] identified in the Technical Report Summary as having been prepared by me and the corresponding section[s] of the Executive Summary.

Date: August 7, 2024

/s/ Melanie Failler

Name: Melanie Failler, ASPB

Title: Principal Environment

Jansen

BHP

For personal use only

## CONSENT OF QUALIFIED PERSON

I, Ozen Turkekul, in connection with the annual report on Form 20-F for the year ended June 30, 2024 and any amendments or supplements and/or exhibits thereto (collectively, the "Form 20-F"), consent to:

- the filing and use of the technical report summary titled "Technical Report Summary – Jansen" (the "Technical Report Summary"), with an effective date of June 30, 2024, as an exhibit to and referenced in the Form 20-F;
- the use of and references to my name, including my status as an expert or "qualified person" (as defined in Subpart 1300 of Regulation S-K promulgated by the Securities and Exchange Commission), in connection with the Form 20-F and the Technical Report Summary;
- any extracts from, or summaries of, the Technical Report Summary in the Form 20-F and the use of information derived, summarized, quoted or referenced from the Technical Report Summary, or portions thereof, that was prepared by me, that I supervised the preparation of and/or that was reviewed and approved by me, that is included or incorporated by reference in the Form 20-F; and
- the incorporation by reference in the Registration Statements on Form S-8 (File Nos. 333-227431, 333-100496, 333-141531 and 333-160636) and Registration Statement on Form F-3 (No. 333-269898) of the above items as included in the Form 20-F.

I am responsible for authoring, and this consent pertains to, the particular section[s] identified in the Technical Report Summary as having been prepared by me and the corresponding section[s] of the Executive Summary.

Date: August 7, 2024

/s/ Ozen Turkekul

Name: Ozen Turkekul, APEGS

Title: Principal Geologist

Jansen

BHP

For personal use only

**Guarantors and Issuers of Guaranteed Securities**

Each of the following securities issued by BHP Billiton Finance (USA) Limited, a wholly owned subsidiary of BHP Group Limited, is fully and unconditionally guaranteed by BHP Group Limited:

4.875% Notes due 2026  
5.250% Notes due 2026  
4.750% Notes due 2028  
5.100% Notes due 2028  
5.250% Notes due 2030  
4.900% Notes due 2033  
5.250% Notes due 2033  
5.500% Notes due 2053

Each of the following securities issued by BHP Billiton Finance (USA) Limited, a wholly owned subsidiary of BHP Group Limited, is fully and unconditionally guaranteed by each of BHP Group Limited and BHP Group (UK) Ltd (formerly BHP Group Plc), a wholly owned subsidiary of BHP Group Limited, on a full and unconditional basis:

5.000% Notes due 2043  
4.125% Notes due 2042

For personal use



# SEC S-K 229.1300 Technical Report Summary Prefeasibility Study Jansen Potash Project Saskatchewan, Canada

For the fiscal year ended: 30 June 2024

Report Prepared for

**BHP Group Limited**  
(ABN 49 004 028 077)

171 Collins Street  
Melbourne  
Victoria  
Australia

For personal use only

### **Note Regarding Forward Looking Statements**

This Technical Report Summary (TRS) contains forward-looking statements, including: statements regarding trends in commodity prices and currency exchange rates; demand for commodities; resources, reserves and production forecasts; plans, strategies and objectives of management; operations or facilities (including associated costs); anticipated production or construction commencement dates; capital costs and scheduling; operating costs and supply of materials and skilled employees; anticipated productive lives of projects, mines and facilities; provisions and contingent liabilities; and tax and regulatory developments.

Forward-looking statements may be identified by the use of terminology including, but not limited to, 'intend', 'aim', 'project', 'see', 'anticipate', 'estimate', 'plan', 'objective', 'believe', 'expect', 'commit', 'may', 'should', 'need', 'must', 'will', 'would', 'continue', 'forecast', 'guidance', 'trend' or similar words. These statements discuss future expectations concerning the results of assets or financial conditions, or provide other forward-looking information.

Forward-looking statements are based on current expectations and reflect judgments, assumptions, estimates and other information available as at the date of this TRS. These statements do not represent guarantees or predictions of future financial or operational performance and involve known and unknown risks, uncertainties and other factors, many of which are beyond the control of BHP and which may cause actual results to differ materially from those expressed in the statements contained in this TRS. Readers are cautioned against reliance on any forward-looking statements or guidance, including in light of the current economic climate. Other factors that may affect actual results are set out in BHP's reports that are filed with, and furnished to, the U.S. Securities and Exchange Commission, including BHP's Annual Report on Form 20-F for the period ended June 30, 2024.

Except as required by applicable regulations or by law, BHP does not undertake to publicly update or review any forward-looking statements, whether as a result of new information or future events.

The production schedule data included in Sections 13 and 19 of this TRS has been prepared to demonstrate the economic viability of the mineral reserves of Jansen only and may differ from production guidance published by BHP from time to time in accordance with the relevant ASX Listing Rules. See Sections 11, 12, 16, 17, 18 and 19 for more information on the pricing and cost assumptions utilised to produce Jansen's production schedule data in this TRS.

Specifically, the production schedule data for the entire life of mineral reserves included in Sections 13 and 19 of this TRS has been prepared utilising the average of Nutrien's quarterly published offshore and onshore realised prices from 2008 through 2023 and annual costs sourced from bottom-up estimates, operational experience and benchmarking, budget quotes from potential vendors, design specifications, and currently contracted rates where applicable, whereas BHP's forward production and cost guidance published in accordance with the ASX Listing Rules are prepared utilising BHP's internally generated projected long-term commodity prices and cost assumptions. Therefore, the production schedule data included in this TRS may differ from BHP's production guidance published in accordance with the ASX Listing Rules.

Report Prepared by:

Qualified Person	Specific Type of Activity and Area of Accountability	Signature	Date
Balazs Nemeth	Mineral Tenure & Mineral Resources – Section 1, 2, 3, 7 (excluding 7.3, 7.4), 11, 13.2.2, 20, 22.1, 24	/s/Balazs Nemeth	30 June 2024
Ozen Turkekul	Mineral Resources – Section 1, 2, 4, 5, 6, 8, 9, 21, 22.1, 24	/s/Ozen Turkekul	30 June 2024
Johannes Sondergaard	Mineral Reserves – Section 1, 2, 12, 13 (excluding 13.2.1, 13.2.2), 15 (excluding 15.6), 16, 17.4-17.7, 19, 22.2, 23, 24, 25 Capital Costs - Section 1, 2, 18.2	/s/Johannes Sondergaard	30 June 2024
Cameron McKinnon	Metallurgy, Processing - Section 1, 2, 10, 14	/s/Cameron McKinnon	30 June 2024
Jairo Gomez	Mineral Reserves, Geotechnical – Section 1, 2, 7.4, 13.2.1	/s/Jairo Gomez	30 June 2024
Graham Reynolds	Operating Costs - Section 1, 2, 18.1	/s/Graham Reynolds	30 June 2024
Melanie Failler	Environmental studies, Permitting - Section 1, 2, 17 Introduction, 17.1, 17.2 (excluding 17.2.1, 17.2.2.), 17.3	/s/Melanie Failler	30 June 2024
Jessica Perras	Tailings disposal - Section 15.6, 17.2.1, 17.2.2	/s/Jessica Perras	30 June 2024

For personal use only

## Table of Contents

1	EXECUTIVE SUMMARY .....	15
1.1	PROPERTY DESCRIPTION AND OWNERSHIP .....	16
1.2	GEOLOGY AND MINERALISATION .....	17
1.3	STATUS OF EXPLORATION, DEVELOPMENT AND OPERATIONS .....	18
1.4	MINERAL RESOURCES AND MINERAL RESERVES ESTIMATES .....	18
1.4.1	<i>Mineral Resources</i> .....	18
1.4.2	<i>Mineral Reserves</i> .....	20
1.5	MINING METHOD .....	20
1.6	PROCESSING AND RECOVERY METHODS .....	21
1.7	INFRASTRUCTURE .....	21
1.8	MARKET STUDIES .....	22
1.9	CAPITAL AND OPERATING COST ESTIMATES .....	22
1.10	ECONOMIC ANALYSIS .....	23
1.11	PERMITTING REQUIREMENTS .....	23
1.12	QUALIFIED PERSON'S CONCLUSIONS AND RECOMMENDATIONS .....	24
2	INTRODUCTION .....	25
2.1	REGISTRANT FOR WHOM THE TECHNICAL REPORT SUMMARY WAS PREPARED .....	25
2.2	TERMS OF REFERENCE AND PURPOSE OF THE REPORT .....	25
2.3	SOURCES OF INFORMATION .....	25
2.4	DETAILS OF INSPECTION .....	25
2.5	REPORT VERSION UPDATE .....	27
3	PROPERTY DESCRIPTION .....	28
3.1	PROPERTY LOCATION .....	28
3.2	MINERAL TENURE .....	29
3.3	MINERAL RIGHTS DESCRIPTION .....	32
3.4	ENCUMBRANCES .....	33
3.5	OTHER SIGNIFICANT FACTORS AND RISKS .....	33
3.6	ROYALTIES OR SIMILAR INTEREST .....	33
4	ACCESSIBILITY, CLIMATE, LOCAL RESOURCES, INFRASTRUCTURE, AND PHYSIOGRAPHY .....	34
4.1	TOPOGRAPHY, ELEVATION, AND VEGETATION .....	34
4.2	MEANS OF ACCESS .....	34
4.3	CLIMATE AND LENGTH OF OPERATING SEASON .....	34
4.4	INFRASTRUCTURE AND AVAILABILITY .....	34
4.5	WATER .....	35
4.6	ELECTRICITY .....	35
4.7	PERSONNEL .....	35
4.8	SUPPLIES .....	35
5	HISTORY .....	36
5.1	PREVIOUS OPERATIONS .....	36
5.2	EXPLORATION AND DEVELOPMENT BY PREVIOUS OWNERS OR OPERATORS .....	36

6	GEOLOGICAL SETTING, MINERALIZATION, AND DEPOSIT .....	38
6.1	REGIONAL GEOLOGY .....	38
6.2	LOCAL GEOLOGY .....	38
6.3	PROPERTY GEOLOGY .....	41
6.4	MINERAL DEPOSIT .....	42
7	EXPLORATION .....	45
7.1	EXPLORATION WORK (OTHER THAN DRILLING) .....	45
7.1.1	<i>Procedures and Parameters Relating to the Surveys and Investigations</i> .....	45
7.1.2	<i>Sampling Methods and Sample Quality</i> .....	46
7.1.3	<i>Information about the Area Covered</i> .....	47
7.1.4	<i>Significant Results and Interpretation</i> .....	47
7.2	EXPLORATION DRILLING .....	49
7.2.1	<i>Drilling Type and Extent</i> .....	49
7.2.2	<i>Drilling, Sampling and Recovery Factors</i> .....	50
7.2.3	<i>Drilling Results and Interpretation</i> .....	52
7.3	HYDROGEOLOGY .....	53
7.3.1	<i>Near Surface Hydrogeology</i> .....	53
7.3.2	<i>Deep Hydrogeology</i> .....	57
7.4	GEOTECHNICAL DATA, TESTING, AND ANALYSIS .....	60
8	SAMPLE PREPARATION, ANALYSES, AND SECURITY .....	63
8.1	SAMPLE PREPARATION METHODS AND QUALITY CONTROL MEASURES .....	63
8.1.1	<i>Methods</i> .....	63
8.1.2	<i>Sample Security</i> .....	65
8.2	SAMPLE PREPARATION, ASSAYING AND ANALYTICAL PROCEDURES .....	65
8.3	QUALITY CONTROL /QUALITY ASSURANCE PROCEDURES .....	66
8.4	OPINION ON ADEQUACY .....	69
8.5	NON-CONVENTIONAL INDUSTRY PRACTICE .....	69
9	DATA VERIFICATION .....	70
9.1	DATA VERIFICATION PROCEDURES .....	70
9.1.1	<i>External Reviews</i> .....	70
9.1.2	<i>Internal Reviews</i> .....	70
9.2	LIMITATIONS .....	70
9.3	OPINION ON DATA ADEQUACY .....	71
10	MINERAL PROCESSING AND METALLURGICAL TESTING .....	72
10.1	TESTING AND PROCEDURES .....	72
10.2	SAMPLE REPRESENTATIVENESS .....	73
10.3	LABORATORIES .....	75
10.4	RELEVANT RESULTS .....	76
10.4.1	<i>Impact of ore variability on plant recovery</i> .....	77
10.5	ADEQUACY OF DATA AND NON-CONVENTIONAL INDUSTRY PRACTICE .....	78
10.6	OPINION ON INFLUENCE FOR ECONOMIC EXTRACTION .....	78
11	MINERAL RESOURCES ESTIMATES .....	79

11.1	KEY ASSUMPTIONS, PARAMETERS, AND METHODS USED.....	79
11.2	GEOLOGICAL MODELLING .....	80
11.3	BLOCK MODELLING.....	80
11.4	VALIDATION .....	82
11.5	CUT-OFF GRADES ESTIMATES.....	83
11.6	REASONABLE PROSPECT FOR ECONOMIC EXTRACTION (RPEE).....	83
11.7	RESOURCE CLASSIFICATION AND CRITERIA.....	83
11.8	UNCERTAINTY.....	85
11.9	MINERAL RESOURCE STATEMENT .....	86
11.10	DISCUSSION OF RELATIVE ACCURACY/CONFIDENCE.....	87
12	MINERAL RESERVE ESTIMATES.....	88
12.1	KEY ASSUMPTIONS, PARAMETERS AND METHODS USED.....	88
12.2	CUT-OFF GRADES ESTIMATES.....	91
12.3	RESERVES CLASSIFICATION AND CRITERIA.....	93
12.4	MINERAL RESERVE STATEMENT.....	94
12.5	DISCUSSION OF RELATIVE ACCURACY/CONFIDENCE.....	94
13	MINING METHODS.....	96
13.1	SELECTED MINING METHOD.....	96
13.2	ADDITIONAL PARAMETERS RELEVANT TO MINE DESIGNS AND PLANS.....	97
13.2.1	<i>Geotechnical Models</i> .....	97
13.2.2	<i>Hydrogeological Models</i> .....	100
13.3	PRODUCTION RATES AND MINE LIFE .....	101
13.4	MINING UNIT DIMENSIONS, MINING DILUTION AND RECOVERY FACTORS .....	102
13.5	OVERBURDEN STRIPPING, UNDERGROUND DEVELOPMENT AND BACKFILLING .....	104
13.6	EQUIPMENT AND PERSONNEL .....	104
13.7	FINAL MINE OUTLINE .....	107
14	PROCESSING AND RECOVERY METHODS.....	109
14.1	PROCESS PLANT .....	111
14.2	PLANT THROUGHPUT AND DESIGN, EQUIPMENT CHARACTERISTICS AND SPECIFICATIONS .....	113
14.3	REQUIREMENTS FOR ENERGY, WATER, PROCESS MATERIALS, AND PERSONNEL.....	114
14.4	NOVEL PROCESSING METHODS .....	115
15	INFRASTRUCTURE.....	116
15.1	ROADS.....	118
15.2	RAIL .....	119
15.3	PORT FACILITIES .....	120
15.4	DAMS.....	120
15.5	DUMPS AND LEACH PADS .....	120
15.6	TAILINGS DISPOSAL .....	120
15.7	POWER, WATER AND PIPELINES .....	121
15.8	UNDERGROUND INFRASTRUCTURE.....	122
15.8.1	<i>Mine bulk material handling (BMH) system</i> .....	122
15.8.2	<i>Underground Electrical Distribution</i> .....	123
15.8.3	<i>Mine ventilation infrastructure</i> .....	123

15.8.4	<i>Dewatering</i> .....	124
15.8.5	<i>Underground maintenance</i> .....	124
15.9	SHAFTS AND HOISTING.....	125
15.9.1	<i>Hoist and headframe</i> .....	125
15.9.2	<i>Shaft liner</i> .....	125
15.10	INFRASTRUCTURE LAYOUT MAP.....	126
16	MARKET STUDIES.....	127
16.1	MARKET INFORMATION.....	127
16.1.1	<i>Product Specifications</i> .....	127
16.1.2	<i>Supply Demand and Pricing</i> .....	128
16.1.3	<i>Competitors</i> .....	131
16.1.4	<i>Market Entry Strategies</i> .....	132
16.2	CONTRACTS AND STATUS.....	133
17	ENVIRONMENTAL STUDIES, PERMITTING, PLANS AND AGREEMENTS.....	136
17.1	ENVIRONMENTAL STUDIES AND IMPACT ASSESSMENTS.....	136
17.2	WASTE AND TAILINGS DISPOSAL.....	138
17.2.1	<i>Waste and Tailings Disposal</i> .....	139
17.2.2	<i>Site Monitoring</i> .....	140
17.2.3	<i>Water Management</i> .....	140
17.3	PROJECT PERMITTING AND APPROVALS.....	141
17.4	SOCIAL PLANS AND AGREEMENTS.....	142
17.5	CLOSURE PLANNING.....	142
17.6	LOCAL PROCUREMENT AND HIRING.....	143
17.7	DISCUSSION OF RELATIVE ACCURACY/CONFIDENCE.....	143
18	CAPITAL AND OPERATING COSTS.....	145
18.1	OPERATING COST.....	145
18.1.1	<i>Operating Cost Estimate</i> .....	145
18.1.2	<i>Basis and Accuracy Level for Cost Estimates</i> .....	147
18.2	CAPITAL COST.....	147
18.2.1	<i>Capital Cost Estimate</i> .....	147
18.2.2	<i>Basis and Accuracy Level for Cost Estimates</i> .....	149
19	ECONOMIC ANALYSIS.....	151
19.1	KEY ASSUMPTIONS, PARAMETERS AND METHODS USED.....	151
19.1.1	<i>Mine Plan Physicals</i> .....	151
19.1.2	<i>Potash Price</i> .....	151
19.1.3	<i>Foreign Exchange Rate</i> .....	151
19.1.4	<i>Capital and Operating Costs</i> .....	151
19.1.5	<i>Closure Costs</i> .....	151
19.1.6	<i>Royalties and Taxes</i> .....	151
19.1.7	<i>Valuation Assumptions</i> .....	152
19.2	RESULTS OF ECONOMIC ANALYSIS.....	153
19.3	SENSITIVITY ANALYSIS.....	154
20	ADJACENT PROPERTIES.....	156

21	OTHER RELEVANT DATA AND INFORMATION.....	158
22	INTERPRETATION AND CONCLUSIONS.....	159
22.1	MINERAL RESOURCES.....	159
22.2	MINERAL RESERVES.....	159
23	RECOMMENDATIONS.....	160
24	REFERENCES.....	161
25	RELIANCE ON INFORMATION PROVIDED BY THE REGISTRANT.....	162

For personal use only



## List of Tables

TABLE 1-1: JANSEN – SUMMARY OF POTASH (EXCLUSIVE) MINERAL RESOURCES (AS AT 30 <sup>TH</sup> JUNE 2024)	19
TABLE 1-2: JANSEN – SUMMARY OF POTASH MINERAL RESERVES (AS AT 30 <sup>TH</sup> JUNE 2024)	20
TABLE 2-1: LIST OF QUALIFIED PERSONS	26
TABLE 2-2: QUALIFIED PERSONS SITE VISITS	27
TABLE 3-1: JANSEN SERVICE SHAFT COORDINATES	28
TABLE 3-2: JANSEN MAIN LEASE AREAS AND ASSOCIATED PAYMENTS	30
TABLE 3-3: SUMMARY OF JANSEN LAND POSITION	33
TABLE 5-1: SUMMARY OF EXPLORATION DRILLING BY PREVIOUS OWNERS	36
TABLE 7-1: SEISMIC SURVEY SAMPLING	46
TABLE 7-2: SUMMARY OF BHP CANADA DRILLING INFORMATION	50
TABLE 7-3: SUMMARY OF HYDRAULIC CONDUCTIVITY VALUES FOR THE NEAR SURFACE HYDROSTRATIGRAPHIC UNITS	55
TABLE 7-4: SUMMARY OF HYDRAULIC PARAMETERS AND VALUES MEASURED IN FIELD FOR THE BRINE DISPOSAL HORIZON	60
TABLE 7-5: CSR TEST RESULTS	61
TABLE 7-6: BRZ TEST RESULTS	61
TABLE 11-1: COMPARISON OF DRILL HOLE, DECLUSTERED (AREA WEIGHTED DRILL HOLE), AND RESOURCE MODEL K <sub>2</sub> O VALUES FROM PLY#1	83
TABLE 11-2: JANSEN – SUMMARY OF POTASH (EXCLUSIVE) MINERAL RESOURCES (AS AT 30 <sup>TH</sup> JUNE 2024)	87
TABLE 12-1: MINE DESIGN MODIFYING FACTORS	89
TABLE 12-2: ROOF BEAM THICKNESS THRESHOLDS	90
TABLE 12-3: ASSUMPTIONS / ESTIMATES FOR CUT-OFF GRADE	92
TABLE 12-4: LIST OF CUT-OFFS CURRENTLY IN USE	92
TABLE 12-5: JANSEN PROJECT KEY VALUE DRIVERS	93
TABLE 12-6: RANGE CASES – GRADE SUMMARY	93
TABLE 12-7: JANSEN – SUMMARY OF POTASH MINERAL RESERVES (AS AT 30 <sup>TH</sup> JUNE 2024)	94
TABLE 13-1: ESTIMATED RUN OF MINE PRODUCTION (BY FINANCIAL YEAR 1 JULY – 30 JUNE, BASED ON FY24 LoA)	101
TABLE 13-2: JANSEN LIFE OF MINE MOBILE EQUIPMENT LIST	106
TABLE 13-3: JANSEN FULL TIME EQUIVALENT PERSONNEL AT STEADY STATE	107
TABLE 16-1: AWARDED AND PENDING PACKAGES	133
TABLE 17-1: JANSEN PROJECT VALUED ECOSYSTEM COMPONENTS AND MITIGATION MEASURES	138
TABLE 18-1: MAJOR COMPONENTS OF OPERATING COSTS FOR JANSEN MINE	146
TABLE 18-2: JANSEN CAPEX BY AREA, US\$B (REAL 2024)	149
TABLE 19-1: ANNUAL CASH FLOW AND SUMMARY	154
TABLE 19-2: RESULTS OF SENSITIVITY ANALYSIS (UNRISKED NPV US\$B)	155
TABLE 25-1: RELIANCE ON INFORMATION PROVIDED BY THE REGISTRANT	162

## List of Figures

FIGURE 1-1: LOCATION OF THE JANSEN POTASH PROJECT .....	16
FIGURE 3-1: LOCATION MAP OF JANSEN .....	29
FIGURE 3-2: LEASE AREAS OF JANSEN .....	32
FIGURE 6-1: REGIONAL GEOLOGY MAP – WESTERN CANADIAN SEDIMENTARY BASIN (GEOLOGICAL MAP OF CANADA – GEOLOGICAL SURVEY OF CANADA).....	38
FIGURE 6-2: MAP OF POTASH DISTRIBUTION WITHIN THE WILLISTON BASIN (MODIFIED FROM FUZESY (1982)).....	39
FIGURE 6-3: SCHEMATIC GEOLOGICAL SECTION SHOWING THE POTASH MEMBERS OF THE PRAIRIE EVAPORITE FORMATION. THE LOCATION OF THE SECTION IS SHOWN ON FIGURE 6-2: .....	40
FIGURE 6-4: STRATIGRAPHIC COLUMN FOR THE JANSEN AREA (AFTER STRATIGRAPHIC CORRELATION CHART ECONOMY.GOV.SK.CA, 2016).....	41
FIGURE 6-5: DETAILED STRATIGRAPHY OF THE PATIENCE LAKE MEMBER.....	42
FIGURE 6-6: THREE MAIN TYPES OF ANOMALIES (MACKINTOSH AND Mc VITTIE (1983)).....	44
FIGURE 7-1: EXPLORATION COVERAGE. THE BLACK LINE SHOWS THE LOCATION OF THE CROSS SECTION DISPLAYED IN FIGURE 7-5. ....	47
FIGURE 7-2: STRUCTURAL FEATURES AND TOP OF PRAIRIE EVAPORITE ELEVATION IMAGED BY 3D SEISMIC .....	48
FIGURE 7-3: OIL RIG USED IN BHP CANADA POTASH EXPLORATION DRILLING .....	49
FIGURE 7-4: THE FOUR SECTIONS OF THE EXPLORATION DRILLING PROGRAM AND ABANDONMENT PROCEDURES. ....	51
FIGURE 7-5: NORTH-SOUTH CROSS SECTION SHOWING MAIN POTASH AND GEOLOGICAL UNITS IMMEDIATELY ABOVE, (DB CARBONATES – DAWSON BAY CARBONATES MEMBER, RB2 – SECOND RED BEDS MEMBER, UPL – UPPER PATIENCE LAKE SUB-MEMBER, LPL – LOWER PATIENCE LAKE SUB-MEMBER, BP – BELLE PLAINE MEMBER). THE VERTICAL AXIS IS IN ELEVATION (M). BOTH HISTORICAL AND BHP CANADA DRILL HOLES ARE INCLUDED. ....	53
FIGURE 7-6: SCHEMATIC NEAR SURFACE HYDROSTRATIGRAPHY IN THE JANSEN PROJECT AREA.....	54
FIGURE 7-7: LOCATION MAP OF BOREHOLES AND MONITORING WELLS .....	56
FIGURE 7-8: SCHEMATIC DEEP HYDROSTRATIGRAPHY IN THE JANSEN PROJECT AREA (MODIFIED BASED ON FIGURE 6-4) .....	58
FIGURE 8-1: CORE LOGGING AND SAMPLING WORKFLOW.....	64
FIGURE 10-1: GEOGRAPHICAL REGIONS FOR METALLURGICAL TESTING. ....	74
FIGURE 11-1: SCHEMATICS OF THE BLOCK MODEL SET UP FOR RESOURCE MODELLING. THE MODEL IS REFERENCED FROM THE 406 SEAM, APPROXIMATE LOCATION OF THE 402 AND 401 SEAMS ARE ALSO SHOWN FOR REFERENCE. ....	81
FIGURE 11-2: PLAN OF THE JANSEN LPL CLASSIFIED MINERAL RESOURCE. NOTE THAT ONLY MEASURED RESOURCE HAS BEEN CONVERTED TO MINERAL RESERVES. WHITE AREAS ARE NOT PART OF THE RESOURCE. ....	85
FIGURE 12-1: NAMING CONVENTION AND TYPICAL ARRANGEMENT OF PILLARS.....	89
FIGURE 13-1: GENERAL ARRANGEMENT OF DEVELOPMENT ACCESS AND PRODUCTION PANELS.....	96
FIGURE 13-2: SCHEMATIC OF LOCAL GEOLOGY, AQUIFER LOCATIONS IN RELATION TO POTASH STRATA .....	98
FIGURE 13-3: CHANGE IN PANEL EXTRACTION WITH INCREASING DEPTH.....	99
FIGURE 13-4: JANSEN ESTIMATED PRODUCTION PROFILE .....	101
FIGURE 13-5: ACTIVE MINING AREA PROGRESSION .....	102
FIGURE 13-6: HISTOGRAM OF MINING ROOM DESIGN HEIGHTS.....	103
FIGURE 13-7: HISTOGRAM OF PLANNED LINEAR METRES TO BE EXCAVATED BY TOP DILUTION THICKNESS INTERVAL .....	104
FIGURE 13-8: JANSEN MINE DESIGN. ....	108
FIGURE 14-1: JANSEN PROCESSING SHEET FLOW .....	111
FIGURE 15-1: SCHEMATIC OF JANSEN OPERATIONS WHEN IN PRODUCTION .....	117
FIGURE 15-2: BASIC VALUE CHAIN.....	118
FIGURE 15-3: OFF-SITE RAIL CONNECTIONS .....	119
FIGURE 15-4: SIMPLIFIED FLOW DIAGRAM OF UNDERGROUND CONVEYOR SYSTEMS.....	123
FIGURE 15-5: INFRASTRUCTURE LAYOUT MAP .....	126
FIGURE 16-1: HISTORICAL RELATIONSHIP BETWEEN CROP PRODUCTION, POPULATION AND POTASH DEMAND.....	128
FIGURE 16-2: MOP SUPPLY BY REGIONS (Mt).....	129

FIGURE 16-3: HISTORICAL MOP PRICING (US\$/T ANNUAL AVERAGE) .....	131
FIGURE 19-1: ANNUAL CASH FLOW (US\$B REAL 2024) .....	153
FIGURE 20-1: JANSEN LEASE AND NEIGHBOURING POTASH DISPOSITIONS AND PROPERTIES. ....	157

For personal use only

## List of Abbreviations

The metric system has been used throughout this report. Tonnes are metric of 1,000 kg, or 2,204.6 lb. All currency is in U.S. dollars (US\$) unless otherwise stated.

<b>Abbreviation</b>	<b>Unit or Term</b>
A	ampere
AAS	atomic absorption spectroscopy
AES	atomic emission spectroscopy
AVDI	Annual visual dyke inspection
A/m <sup>2</sup>	amperes per square metre
BMH	Bulk material handling
BRZ	Brazilian Indirect Tensile Strength
°C	degrees Centigrade
CAGR	Compound Annual Growth Rate
CFR	Cost and Freight
cm	centimetre
cm <sup>2</sup>	square centimetre
cm <sup>3</sup>	cubic centimetre
CMC	constant mean stress
CMR	Combined Magnetic Resonance
CSR	constant strain rate
CY	calendar year
°	degree (degrees)
DPM	Diesel Particulate Matter
EBS	Extendable Belt System
EDF	Environmental Design Flood
EIA	Environmental Impact Assessment
EIS	Environmental Impact Statement
EMP	Environmental Management Plan
FMT	Formation Multi-tester
FOB	Free on Board
FOS	Factor of Safety
FTE	full-time equivalent
Ft	foot (feet)
FY	financial year
G	gram
Gal	gallon
GISTM	Global Industry Standard on Tailings Management
g/L	gram per litre
Gpm	gallons per minute
GPR	ground penetrating radar
GJ/year	gigajoules per year
Gpa	gigapascals
Ha	hectares
HDPE	High Density Polyethylene
Hp	horsepower
HRIA	Heritage Resource Impact Assessment
Hrs	hours
IA	Indigenous Agreement
ICP	inductively coupled plasma
IDF	Inflow Design Flood
IOC	Integrated Operations Centre
JEMP	Jansen Environment Management Plan
JS1	Jansen Stage 1
JS2	Jansen Stage 2
KCl	Potassium Chloride
kg	kilograms
km	kilometre
km <sup>2</sup>	square kilometre
kPa	kilopascal
kV	kilovolt
kWh	kilowatt-hour
kWh/t	kilowatt-hour per metric tonne

<b>Abbreviation</b>	<b>Unit or Term</b>
L	litre
L/sec	litres per second
L/sec/m	litres per second per meter
L/y	litres per year
Lb	pound
LFA	Live Fluid Analyser
LHD	Long-Haul Dump truck
LLDDP	Linear Low Density Polyethylene Plastic
LoA	Life of asset
LoM	Life-of-Mine
LPL	Lower Patience Lake sub-member
LRMC	long run marginal cost
m	metre
m/s	metres per second
m <sup>2</sup>	square metre
m <sup>3</sup>	cubic metre
m <sup>3</sup> /y	cubic metres per year
m <sup>3</sup> /t	cubic metres per tonne
masl	metres above sea level
mD	milliDarcy
ms	millisecond
MCM	Thousands of Circular Mills (thickness)
MDT	Modular Formation Dynamic Tester
mg/L	milligrams/litre
mm	millimetre
MOE	Saskatchewan Ministry of Environment
MOP	Muriate of Potash
MPa	megapascals
Mt	million tonnes
Mtpa	million tonnes per year
MW	million watts
MWh/year	million watt hours per year
Myr	million years
m/s	metres per second
NI 43-101	Canadian National Instrument 43-101
NMR	Nuclear Magnetic Resonance
NPI	Non – Process Infrastructure
OWL	Outer Welded Liner
%	per cent
PCS	Process Control System
Psi	pounds per square inch
PVE	production volume estimate
QA/QC	Quality Assurance/Quality Control
RC	Reverse circulation drilling
RoM	Run-of-Mine
RWW	Raw Water Well
SB	Shadow band
Sec	second
SER	Saskatchewan Ministry of Energy and Resources
SG	specific gravity
SME	subject matter expert
SRC	Saskatchewan Research Council
SRMC	short run marginal cost
SSEWS	Saskatoon Southeast Water Supply
STP	sewage treatment plant
t	tonne (metric ton) (2,204.6 pounds)
TCC	Tri-axial compression creep
TMA	tailing management area
tph	tonnes per hour
TSF	Tailings Storage Facilities
UPL	Upper Patience Lake sub-member
US SEC	US Securities and Exchange Commission
UTM	Universal Transverse Mercator
V	volts

<b>Abbreviation</b>	<b>Unit or Term</b>
VIT	Vertical Interface Test
VFD	variable frequency drive
W	watt
WCSB	Western Canadian Sedimentary Basin
WRA	whole rock analysis
Y	year
2D	Two dimensions
3D	Three dimensions

For personal use only

## 1 Executive Summary

This report was prepared as a Prefeasibility Study-level Technical Report Summary in accordance with the US Securities and Exchange Commission (SEC) Regulation S-K (Title 17, Part 229, Items 601(b)(96) and S-K 1300) for BHP Group Limited on the Jansen Potash Project (Jansen) development stage property. BHP Group Limited has a 100 per cent ownership of Jansen.

This document describes the Jansen Project, which is the combined Stage 1 and Stage 2 development at Jansen, noting all future staged production expansion as beyond the scope of the document.

The scope of the Jansen Project is currently comprised of:

- A fully lined service shaft with permanent hoists capable of 1,750 tph, equipped with steel guides and loading/unloading to accommodate two 50-tonne skips and a 90-person service cage;
- A fully lined production shaft. The existing sinking arrangement will undergo a hoist and headframe changeover to accommodate the interim hoisting requirements for the lateral connection of the two shafts and subsequent shaft pillar development. The interim arrangement of the production shaft will be changed over to a permanent arrangement equipped with steel guides and loading/unloading to accommodate two 75-tonne skips capable of 2,200 tph to 2,700 tph of hoisting, noting engineering is ongoing;
- A shaft pillar area with skip loading facilities, conveyor networks, raw ore storage bins, remote ore storage area, refuge stations, workshops, materials management areas, offices, principal refuge chambers, mobile equipment battery charging stations, and parking areas;
- Establishment of three mining districts that host the production mining panels and supporting development units, and are connected to the shaft infrastructure through conveyor networks;
- Production and development mining equipment, including MF460 borers, extendable belt systems, continuous miners, batch haulage equipment, and supporting fleet of underground personnel and service vehicles;
- Two 1,483 tph ore processing plants including:
  - Raw ore handling, storage, and crushing;
  - Process mill building wet area comprising attrition scrubbing, desliming, flotation, and debrining;
  - Process mill building dry area comprising drying, screening, compaction, and glazing;
  - Tailings processing and reagents;
  - Product handling, storage, screening, and loadout;

- Non-process infrastructure, including a tailings management area, administration building, warehousing, workshops, utilities, on-site rail, and financial support for port facility conversion to ship product to overseas markets.

### 1.1 Property Description and Ownership

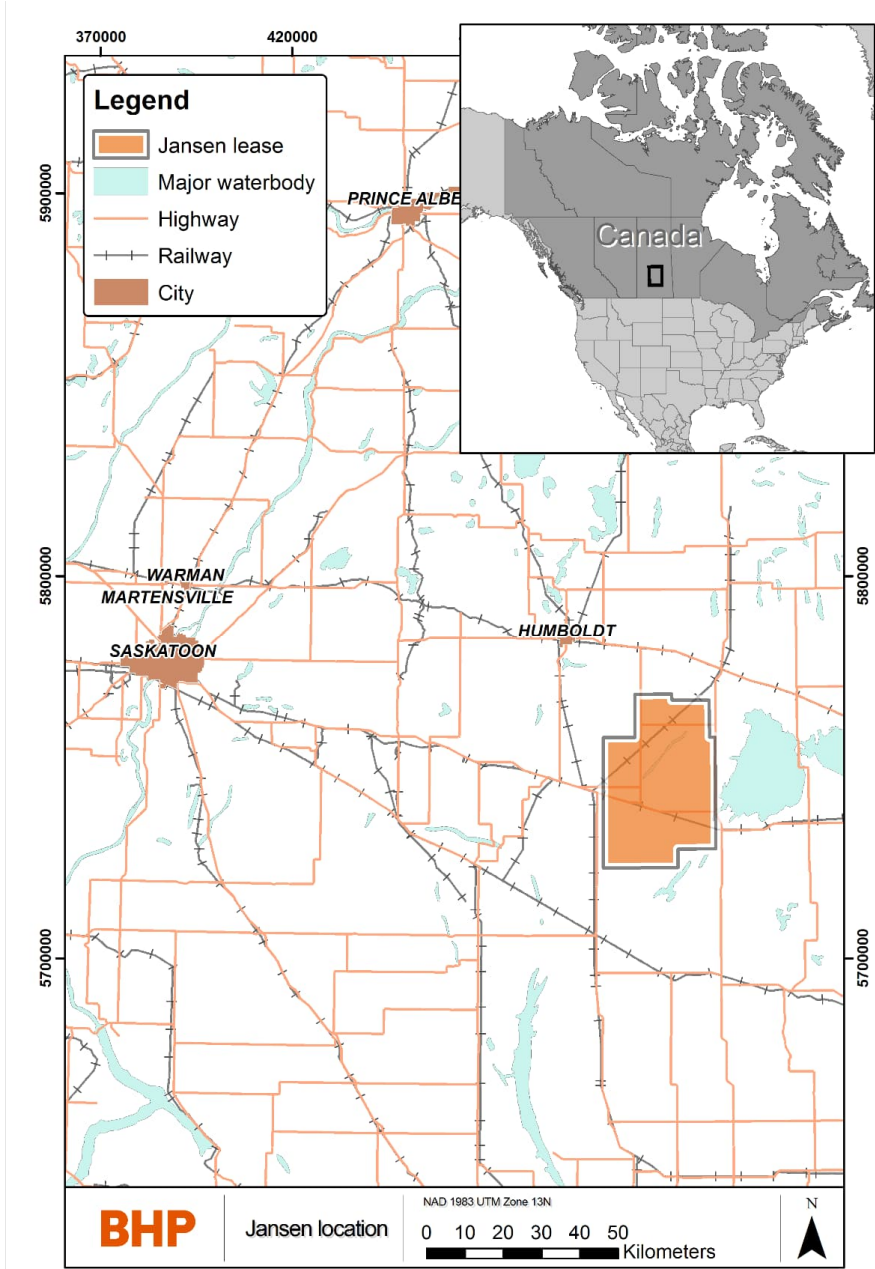

**Figure 1-1: Location of the Jansen Potash Project**

The Jansen Potash Project is located in the Province of Saskatchewan, Canada, approximately 150 kilometres east of the city of Saskatoon (Figure 1-1). The site is accessed by road from provincial Highway 16, approximately 12 kilometres to the south, and Highway 5, approximately 32 kilometres to the north. There is a commercial international airport located in Saskatoon.

The Jansen site is in a rural setting in Saskatchewan, Canada, with small farming communities located nearby. The closest city is Humboldt with a population of about 6,000 and is located approximately 60 kilometres away. The Jansen site is currently under active construction.

For personal use only



The Jansen project is located exclusively within the Subsurface Mineral Lease KLSA 011 ('KLSA 011'), which is wholly owned and operated by BHP Canada Inc. (BHP Canada). The KLSA 011 agreement gives BHP Canada the exclusive right to search for, dig, work, mine, extract, recover, process and carry away subsurface minerals under or within all of the Saskatchewan Crown mineral parcels. The term of the lease is twenty-one years, commencing on 23 November 2012, and is renewable at the option of BHP Canada for successive terms of twenty-one years each.

Most mineral parcels inside the boundaries of KLSA 011 are owned by the Saskatchewan Crown (~1,033 square kilometres). The remaining mineral parcels (~123 square kilometres) are owned by individuals and/or corporations.

## 1.2 Geology and Mineralisation

Potash is the common name given to a group of minerals and chemicals that contain potassium (K) which is a basic nutrient for plants and an important ingredient in fertilizer. Potash is produced as potassium chloride (KCl) in Saskatchewan from sylvinite rock that is a mixture of Sylvite (KCl) and Halite (NaCl) minerals. The KCl content is measured and refer to it in terms of potassium oxide (%K<sub>2</sub>O) equivalence. %K<sub>2</sub>O grade is equivalent to KCl content using the mineralogical conversion factor of 1.583. Jansen potash deposit is composed of combinations of halite (NaCl), sylvite (KCl) with variable mounts of disseminated insolubles and clay seams.

The Jansen potash deposit is located within the Williston Basin, a large, intracratonic, horizontally bedded sedimentary basin. The geology of the basin and its geological formations are well known from extensive exploratory drilling for hydrocarbons and minerals and from geophysical data collected since 1952. This basin wide geological information is publicly available from the Saskatchewan Geological Survey in the form of maps, cross-sections, drill hole-based formation contact identification, core from historical drill holes, and other publications. Potash exploration drill hole information in Saskatchewan becomes publicly available five years after drilling under current Saskatchewan regulations.

The potash beds are hosted within the Prairie Evaporite (PE) Formation, in regionally extensive, horizontal layers during the repeated, cyclical evaporation of a shallow, inland sea during the Devonian period.

In Jansen, the potash is at a depth of approximately 800 metres to approximately 1,050 metres. Two Potash members are present in Jansen those being the Patience Lake and Belle Plaine members. The Patience Lake Member is further subdivided into Upper Patience Lake (UPL) and Lower Patience Lake (LPL) sub-members. The LPL sub-member is the potash horizon targeted for Jansen. The LPL sub-member is composed of sylvite (KCl), halite (NaCl) with variable amounts of disseminated insolubles and clay seams. Carnallite (KCl.MgCl<sub>2</sub>.6H<sub>2</sub>O), a mineral which can impact processing and ground stability, occasionally occurs in place of sylvite within the potash layer. Carnallite can typically be mapped using 3D seismic survey information.

The potash deposit extends from east to west in the province and, based on information available to date, shows relative uniformity, except where there are anomalies due to local dissolutions of the potash beds or clay seams. The main types of anomalies are called washout, leach and collapse anomalies.

### 1.3 Status of Exploration, Development and Operations

The Jansen Project is a Greenfield underground potash mine currently in construction.

Drilling and seismic surveys (2D and 3D) are the primary methods for potash exploration. The area was explored by various companies starting in the 1950s. Modern exploration started in 2006 and was completed in 2012, with a drilling program and acquisition of 3D seismic surveys over 75 per cent of the Jansen lease completed.

The capital invested in the Jansen Project by BHP includes funds allocated for construction of the shafts and associated infrastructure, as well as engineering and procurement activities, and preparation works related to underground infrastructure.

A substantial portion of the site grading, drainage and road network that is expected to be required to commence mining/production is in place.

The site is connected to off-site infrastructure, including natural gas, permanent electrical power, communication fiber and non-potable water.

There have been several facilities installed to date for both permanent operations and temporary construction purposes that have been installed to date including:

- The Discovery Lodge camp (2,600 beds) for housing the construction workforce
- A water treatment plant and raw water well for provision of potable water
- A sanitary sewage treatment plant
- Service and Production headframes and ventilation plenums
- Permanent cold storage warehouse & laydown areas for material storage/staging
- Guard houses and site fencing
- Storm water ponds and effluent storage facilities
- Environmental monitoring equipment for ground water, air quality, noise and vibration levels
- 230kV transformer station

The construction period is expected to be six years and began in 2021. First product from Jansen mine is expected in 2026, with full production expected in 2029.

### 1.4 Mineral Resources and Mineral Reserves Estimates

#### 1.4.1 Mineral Resources

The Jansen Project is located in the Saskatchewan Potash Basin, one of the world's top three producing potash basins, with seven producing conventional mines and three producing solution mines. Based on the information available to date, the resource characteristics of Jansen are comparable to the other potash mines in the area: the resources include an extensive area of shallowly dipping, consistent, large tonnage, high grade, potash at a depth between approximately 800 metres and approximately 1,050 metres.

The potash LPL sub-member from the top of the 406 clay seam to 3.96 metres below the top of the 406 clay seam is defined as the resource. The resource model generated from the drilling data and spatially dense 3D seismic data provides detailed information on the geological domains and on the qualities of the resource. Only Measured Resources have been converted to Probable Reserves.

Due to the extensive data coverage of over 75 per cent of the Jansen lease, no further exploration from surface is planned to validate the reported Mineral Resources and Mineral Reserves.

The Mineral Resources are reported exclusive of the Mineral Reserves. Summary Mineral Resources estimates for Jansen at the end of the Fiscal Year Ended 30 June 2024 are provided in Table 1-1.

**Table 1-1: Jansen – Summary of Potash (Exclusive) Mineral Resources (as at 30<sup>th</sup> June 2024)**

Potash <sup>1,2</sup>	Mining method	Measured Mineral Resources				Indicated Mineral Resources				Measured + Indicated Mineral Resources				Inferred Mineral Resources							
		Tonnes		Qualities		Tonnes		Qualities		Tonnes		Qualities		Tonnes		Qualities					
		Mt	%K <sub>2</sub> O	%Insol.	%MgO	Mt	%K <sub>2</sub> O	%Insol.	%MgO	Mt	%K <sub>2</sub> O	%Insol.	%MgO	Mt	%K <sub>2</sub> O	%Insol.	%MgO				
<b>Canada</b>																					
Jansen <sup>3,4,5,6,7,8,9,10</sup>																					
LPL	UG	-	-	-	-	-	-	-	-	-	-	-	-	-	-	-	-	1,280	25.6	7.7	0.08
<b>Total potash</b>		-	-	-	-	-	-	-	-	-	-	-	-	-	-	-	-	<b>1,280</b>	<b>25.6</b>	<b>7.7</b>	<b>0.08</b>

- (1) Mineral resources are being reported in accordance with S-K 1300 and are presented for the portion attributable to BHP's economic interest. All tonnes and quality information have been rounded, small differences may be present in the totals.
- (2) Mineral resources are presented exclusive of mineral reserves.
- (3) Jansen, in which BHP has a 100% interest, is considered a material property for the purposes of item 1304 of S-K 1300.
- (4) The point of reference for the mineral resources was in situ.
- (5) Mineral resources estimate was based on a potash price of US\$391/t (Real 2024 basis).
- (6) Mineral resources are stated for the Lower Patient Lake (LPL) potash unit and using a seam thickness of 3.96 m from the top of 406 clay seam.
- (7) Mineral resources are based on the expected metallurgical recovery of 88%.
- (8) Potash or sylvite (KCl) content of the deposit is reported in potassium oxide form (K<sub>2</sub>O). %K<sub>2</sub>O grade is equivalent to %KCl content using a mineralogical conversion factor of 1.583.
- (9) Mineral resources tonnages are reported on an in situ moisture content basis and was estimated to be 0.3%.
- (10) The sole purpose of the presented information above is to demonstrate the economic viability of the mineral reserves for the purposes of reporting in accordance with S-K 1300 only and should not be used for other purposes. The annual cash flow data was prepared based upon Pre-Feasibility-level studies and the historic average prices and costs described in this Technical Report Summary; it is subject to change as assumptions and inputs are updated. The information presented does not guarantee future financial or operational performance. The presented information contains forward-looking statements. Please refer to "Note Regarding Forward Looking Statements" at the front of this Technical Report Summary.

## 1.4.2 Mineral Reserves

The Mineral Reserves outlined in Table 1-2 are based upon a Measured Resource noting the Mineral Resources are reported on an exclusive basis from the Mineral Reserve. The Mineral Reserves are acknowledged to be at a Probable level of confidence given the underground development to date is not sufficient to validate the modifying factors.

**Table 1-2: Jansen – Summary of Potash Mineral Reserves (as at 30<sup>th</sup> June 2024)**

Potash <sup>1</sup>	Mining Method	Proven Mineral Reserves				Probable Mineral Reserves				Total Mineral Reserves			
		Tonnes		Qualities		Tonnes		Qualities		Tonnes		Qualities	
		Mt	%K <sub>2</sub> O	%Insol.	%MgO	Mt	%K <sub>2</sub> O	%Insol.	%MgO	Mt	%K <sub>2</sub> O	%Insol.	%MgO
<b>Canada</b>													
Jansen <sup>2,3,4,5,6,7,8,9</sup>													
LPL	UG	–	–	–	–	1,070	24.9	7.5	0.10	1,070	24.9	7.5	0.10
<b>Total potash</b>		<b>–</b>	<b>–</b>	<b>–</b>	<b>–</b>	<b>1,070</b>	<b>24.9</b>	<b>7.5</b>	<b>0.10</b>	<b>1,070</b>	<b>24.9</b>	<b>7.5</b>	<b>0.10</b>

- (1) Mineral reserves are reported in accordance with S-K 1300 and are presented for the portion attributable to BHP's economic interest. All tonnes and quality information have been rounded, small differences may be present in the totals.
- (2) Jansen, in which BHP has a 100% interest, is considered a material property for the purposes of item 1304 of S-K 1300.
- (3) The point of reference for the mineral reserves was ore as delivered to the mill for processing.
- (4) Mineral reserves estimate was based on a potash price of US\$391/t (Real 2024 basis).
- (5) Mineral reserves estimates cut-off is a function of mining parameters and seam thickness. The calculated cut-off grade from economic modelling where the mine plan would be break-even is 8.1% K<sub>2</sub>O.
- (6) Mineral reserves are based on the expected metallurgical recovery of 88%.
- (7) Potash or sylvite (KCl) content of the deposit is reported in potassium oxide form (K<sub>2</sub>O). %K<sub>2</sub>O grade is equivalent to %KCl content using a mineralogical conversion factor of 1.583.
- (8) Mineral reserves tonnages are reported on an in situ moisture content basis and was estimated to be 0.3%.
- (9) The sole purpose of the presented information above is to demonstrate the economic viability of the mineral reserves for the purposes of reporting in accordance with S-K 1300 only and should not be used for other purposes. The annual cash flow data was prepared based upon Pre-Feasibility-level studies and the historic average prices and costs described in this Technical Report Summary; it is subject to change as assumptions and inputs are updated. The information presented does not guarantee future financial or operational performance. The presented information contains forward-looking statements. Please refer to "Note Regarding Forward Looking Statements" at the front of this Technical Report Summary.

## 1.5 Mining Method

The Jansen Mine is expected to be an underground potash mine extracting the LPL sub-member within the Prairie Evaporite Formation. The orebody gently undulates over large distances, has well defined boundary conditions, and has a reasonably consistent ore grade. Mining will take place on a single level in three separate districts.

The planned mining method is long room and pillar. Production mining rooms are expected to be excavated in two passes to a final width of 12 metres using track-mounted borer miners and extendable conveying systems. Mined ore is expected to be transported to the shaft area for hoisting using a roof or floor mounted conveyor network.

Pillars contribute to the mining room stability for safe working conditions and are derived from empirical and numerical models using expected geological conditions, depth, extraction ratio, extraction rates, and expected useful life of the entries. The mine has been designed with consideration of the expected geotechnical and hydrogeological conditions to manage the mining induced subsidence. Maintaining the integrity of the overlying shale, limestone and halite units act as a protective barrier from risk of brine inflow to the mine. The high density 3D seismic survey identifies the geological conditions that present an increased risk for fluid movement.

## 1.6 Processing and Recovery Methods

Unit operations that are expected to make up the Jansen processing facilities are common to conventional potash mines in Saskatchewan, and will include:

- Raw ore handling, storage, and crushing;
- Process mill building wet area comprising attrition scrubbing, desliming, flotation, and debrining;
- Process mill building dry area comprising drying, screening, compaction, and glazing;
- Tailings processing and reagents;
- Product handling, storage, screening, and loadout.

The two Jansen processing plants are designed to be a fit-for-purpose high-recovery facility, each capable of processing 1,483 tonnes per hour wet basis (or 1,479 tph dry basis) of raw ore to produce red fertilizer grade potash (muriate of potash) sized for both standard and granular product types.

## 1.7 Infrastructure

Discovery Lodge, the Jansen construction camp, has been constructed, is currently in use and has a capacity of 2,600 people. Communications, power, water, and natural gas are provided by provincial crown corporations. The pipeline connection to the Saskatoon South East Water Supply system for Jansen's primary water use is complete. The natural gas supply pipeline has been installed and is in use at the on-site accommodation, sewage treatment plant, and concrete batch plant. The permanent 230 kV power supply has been constructed and commissioned.

Upgrades to the secondary roads to the Jansen mine site from the paved provincial highway network have been completed.

The Jansen project has two mine shafts, the service shaft and the production shaft. Both shafts have an internal diameter of 7.3 metres and are excavated to a depth of approximately 1,000 metres. Both shafts are lined with an integral hydrostatic concrete/steel composite design with waterproofing is provided by an outer welded liner from a depth of 835 metres.

The hoisting systems will use ground mounted Koepe hoists (friction hoists) hosted in a typical A-Frame steel construction headframe. The service shaft permanent headframe, hoist houses, and collar house are constructed. The production shaft sinking headframe and ground mounted drum winders are installed and in use.

A tailings management area will store the mine waste produced and hosted separate coarse and fine tailings areas. Waste process water will be disposed through a disposal well network into the Deadwood Formation.

A third-party rail provider will transport the potash produced from the Jansen site to the port terminal, located in Delta, British Columbia, Canada, which is owned and operated by a third-party provider. The port facility will unload the railcars, store the product, and load shipping vessels.

## 1.8 Market Studies

Potassium content is commonly measured in units of potassium oxide ( $K_2O$ ), (a notional substance), rather than units of K. MOP used in agricultural application is typically ~95 % KCl, which is equivalent to ~60 %  $K_2O$ ; this is in general the threshold required to qualify product in most major agricultural markets. Jansen plans to sell two agricultural potash grades, red standard (~60 %  $K_2O$  equivalent, ~0.5 to 1 millimetre in size) and red granular (~60 %  $K_2O$  equivalent, ~3 to 4 millimetres in size) potash, to retain simplicity while seeking sufficient market access.

Global demand for potash fertilizers is driven by the need for higher crop production to feed a growing and more affluent, global population. It is also driven by the need to reduce reliance on native soil potassium, which in many places may be unable to support the necessary increase in crop yields. Historically, the relationship between population growth, crop production and potash demand has been reliable and therefore considered to provide a reasonable basis for projecting future fertiliser needs.

According to independent market analyst CRU, it estimates that about three-quarters of MOP production comes from underground ores – mainly located in Canada, Russia and Belarus. It is simple and established technology, low-cost and energy efficient. Much of the remainder is extracted from natural brines in China and the Dead Sea. Ore is most commonly processed through flotation that yields a product that is pink or red and usually about 95 per cent pure. Jansen is designed to employ conventional underground mining and flotation.

Most potash operations produce between 1 and 4 Mtpa. Most of the potash mines in Canada date back to a period of rapid development in the 1960s and 1970s, while much of the capacity in Russia and Belarus was built in the Soviet era. The potash industry structure is presently characterized by a small number of large suppliers. In terms of supply concentration, four producers (Nutrien, Mosaic, Uralkali and Belaruskali) are estimated to have accounted for ~65 per cent of global production in 2020.

It is expected that BHP will market directly to customers via a network of regional offices, leveraging BHP's existing global footprint and capabilities.

BHP is expected to focus on upstream Cost and Freight (CFR) sales and may benefit from being able to direct-rail to North American customers. Jansen is expected to have logistics optionality and flexible granular processing capacity that may enable a shift of sales between export regions and North America, depending on the market.

Memorandums of understanding have been developed noting no sales contracts have been established.

## 1.9 Capital and Operating Cost Estimates

The Capital Cost Estimate (Capex) and Operating Cost Estimate (OPEX) were developed by BHP Canada, its consultants and engineering service providers using processes to quantify, cost, and price the resource estimates that is included within the Jansen project scope.

The Jansen project scope includes a lined service and production shaft mining equipment, underground development, and infrastructure necessary to support operations. The service shaft is expected to be capable of hoisting 1,750 tph, and the production shaft is expected to be capable

of hoisting 2,200 tph to 2,700 tph. Two 1,483 tph processing plants and non-processing infrastructure, including a tailings management area.

The capital costs for the Jansen project are aligned with the mine gate pricing and therefore exclude off-site rail and port. A total installed cost was estimated to be Real US\$9.0 billion and inclusive of up to but not exceeding 15 per cent contingency, and an accuracy range of +/-25 per cent.

The OPEX for the Jansen project was developed to capture costs defined as mine gate. This includes all costs spanning from the mining face underground to the loading of product to rail at site.

The Operating Cost Estimate includes all personnel and activities within the battery limits of the scope, and includes operational and statutory management, administration, and support personnel associated with the operation.

The average operating cost over the life of Jansen project is estimated to be US\$90/tonne KCl. Cash operating cost includes a mixture of fixed costs, variable costs, and sustaining capital and are aligned with an assumed mine gate sales point therefore exclude Port and off-site Rail cost.

## 1.10 Economic Analysis

The analysis that supports the Jansen Mineral Resource and Mineral Reserve economic viability testing is an excel model based on annual cash flow projections. Annual cash flows projections include sales revenue (sales point FOB Mine), operating and closure costs, capital expenditures, royalties, income and production taxes.

The Jansen annual cash flow projections, utilizing the assumptions detailed within this report, result in a discounted after-tax cash flow of US\$11.2B and an IRR of 18.3 per cent utilizing a 7.0 per cent discount rate. The Jansen project remains economically viable under a range of scenarios including deviations in price, production, foreign exchange rates, capital expenditures and operating costs.

## 1.11 Permitting Requirements

The Jansen Project Environmental Impact Statement (EIS), which BHP Canada submitted to the Saskatchewan Ministry of Environment in 2010, received Ministerial Approval on 29 June 2011.

Since the EIS approval, further engineering and project optimization was completed that resulted in changes to the mine plan, site layout, and schedule. To maintain Ministerial Approval, two submissions were made in November 2017 to the MOE Environment Assessment and Stewardship Branch under Section 16 of The Environmental Assessment Act. Approval was received for both submissions on 19 April 2018. To address a potential increase in production rate, the Project Optimization and EIS Review Summary was submitted and approved on 19 July 2023.

Following the Approval of the EIS, Jansen required federal, provincial and municipal permits and approval for construction and operation. Jansen maintains an electronic permit register that lists all permits for the Project. BHP Canada has received all permits that have been applied for to-date and expects to be able to obtain the required construction and operation permits for Jansen.

BHP Canada has a terminal services and development agreement in place with Westshore for development and shipping services. The Vancouver Fraser Port Authority Project Environmental Review Permit #20-209 and the water discharge permit amendment (BC Ministry of Environment and Climate Change Strategy Permit 6819) have been issued. The Metro Vancouver air quality management permit GVA0153 has not been issued.

## 1.12 Qualified person's conclusions and recommendations

It is the opinion of the Qualified Person, based on the available data, the known limitations of the data, interpretations, and methodologies, the Jansen Mineral Resource estimate is considered fit for purpose in supporting and forming the basis of the Mineral Reserves estimate.

No recommendations for further exploration have been identified during project execution and later in operations, geological mapping, interpretation and sampling programs implemented as part of the reconciliation process are expected to be sufficient to address the identified Mineral Resource uncertainties.

Uncertainties that affect the reliability or confidence in the Mineral Resource and Mineral Reserve estimate include but are not limited to:

- Future macro-economic environment, including product prices and foreign exchange rate
- Changes to operating cost assumptions, including labour costs
- Ability to continue sourcing water from the Saskatoon South East Water Supply
- Changes to mining, hydrogeological, geotechnical parameters and assumptions reflected in mining recovery
- Ability to maintain environmental and social license to operate
- Integrity of the shaft liner beyond the design life of 70 to 80 years.

Confidence in the Mineral Reserve is reflected in the applied reserve classifications in accordance with the US SEC S-K 1300 with factors influencing classification including but not limited to mining methods, processing methods, economic assessment and other life of asset and closure assessments.

In the opinion of the Qualified Person the confidence in the modifying factors is reasonably translated to the Probable Mineral Reserves characterisation and their derivation from Measured Resource estimates.



## 2 Introduction

### 2.1 Registrant for Whom the Technical Report Summary was Prepared

This Technical Report Summary was prepared in accordance with the US Securities and Exchange Commission (US SEC) S-K regulations (Title 17, Part 229, Items 601 and 1300 through 1305) for BHP Group Limited (BHP) to support its declaration of Potash Mineral Resources and Mineral Reserves on its Jansen Potash Project (Jansen) for the fiscal year ended on 30 June 2024.

### 2.2 Terms of Reference and Purpose of the Report

This report covers Mineral Resources and Mineral Reserves and is issued in support of the BHP Canada Jansen Potash Project declaration. This document describes the combined Stage 1 and Stage 2 development at Jansen, noting all future stage production expansion as beyond the scope of the document.

This Technical Report Summary was prepared to support the disclosure of Mineral Resources and Mineral Reserves for the fiscal year ended on 30 June 2024 in compliance with the US SEC S-K regulations (which came into effect on 1 January 2021). This report does not include any exploration results that are not part of Jansen's Mineral Resources or Mineral Reserves.

### 2.3 Sources of Information

This report is based on internal technical reports, studies, and field programs, published government reports, published government and historical data, and public information as cited throughout this report and listed in the Section 24, available at the time of writing this TRS.

Unless otherwise stated, all figures and images were prepared by BHP Canada. Units of measurement referenced in this report are based on local convention in use at the property and currency is expressed in US dollars.

Reliance upon information provided by the registrant is listed in Section 25 when applicable.

### 2.4 Details of Inspection

BHP has relied on the Qualified Persons listed in Table 2-1 to prepare the information and this report supporting its disclosure of Mineral Resources and Mineral Reserves at a Preliminary Feasibility Study-level. All Qualified Persons, except one, are full time employees of BHP, with the chapters and sections noted for which each Qualified Person is responsible for.

For personal use only

**Table 2-1: List of Qualified Persons**

QP Name	Relation to Registrant and their Role	Qualification	Professional Organization and Membership level	Years of Relevant Experience	Responsible for disclosure of
Balazs Nemeth	Full-time Employee / Principal Geophysicist	PhD Geophysics	MAusIMM	22	Mineral Tenure & Mineral Resources – Section 1, 2, 3, 7 (excluding 7.3, 7.4), 11, 13.2.2, 20, 22.1, 24
Ozen Turkekul	Full-time Employee / Principal Geologist	B.Eng. Geological Engineering M.A.Sc. Economic Geology	APEGS	23	Mineral Resources – Section 1, 2, 4, 5, 6, 8, 9, 21, 22.1, 24
Johannes Sondergaard	Full-time Employee / Manager Resource Engineering	Bachelor of Science in Mining Engineering	MAusIMM	20	Mineral Reserves – Section 1, 2, 12, 13 (excluding 13.2.1, 13.2.2), 15 (excluding 15.6, 15.9), 16, 17.4-17.7, 19, 22.2, 23, 24, 25 Capital Costs – Section 1, 2, 18.2
Cameron McKinnon	Full-time Employee / Manager Process Engineering	BEng Metallurgical Engineering	APEGS	28	Metallurgy, Processing – Section 1, 2, 10, 14
Jairo Gomez	Full-time Employee / Principal Geotechnical Engineer	M Sc A. Applied Sciences – Mineral Resources Engineering – Rock Mechanics,	APEGS	35	Mineral Reserves, Geotechnical – Section 1, 2, 7.4, 13.2.1
Graham Reynolds	Full-time Employee / Head of Production	Bachelor of Science in Engineering	MAusIMM	30	Operating Costs – Section 1, 2, 18.1
Melanie Failler	Full-time Employee / Principal Environment	Bachelor of Science	ASPB	23	Environmental studies, Permitting – Section 1, 2, 17 introduction, 17.1, 17.2 (excluding 17.2.1, 17.2.2.), 17.3
Jessica Perras	Full-time Employee / Tailings & Closure Planner	Bachelor of Science in Geosciences	APEGS	10	Tailings disposal – Section 15.6, 17.2.1 17.2.2

Table 2-2 summarizes the details of the personal inspections on the property by each qualified person or, if applicable, the reason why a personal inspection has not been completed.

**Table 2-2: Qualified Persons Site Visits**

QP Name	Details of Inspection
Johannes Sondergaard	Focus on the early construction associated with the shafts and headframes, mill construction, temporary and permanent utilities, tailings management area, and offsite road infrastructure. (2024)
Cameron McKinnon	Many visits over 9 years for site familiarization and collaboration with site execution teams. Has also been involved with water treatment, freeze plant, and sewage treatment plant operations.
Graham Reynolds	Regular monthly visits since 2022 supporting the site as the General Manager for Operation Readiness.
Ozen Turkekul	Multiple underground visits especially around the potash zone during shaft sinking and station cutting for geological characterization and sampling in 2018.
Melanie Failler	Frequent site visits since January 2019, including environmental field programs and supporting external inspections and audits.
Jairo Gomez	Regular quarterly site visits and following up on reports from resident Geotech and Geology professionals.
Balazs Nemeth	Exploration drilling and seismic during the period of 2008 to 2010.
Jessica Perras	Completed various field investigation starting in 2012 supporting study work. Frequent visits since 2019 supporting field programs, audits and inspections. Monthly site visits since July 2023 for tailings facility observation and inspections.

## 2.5 Report Version Update

The Technical Report Summary for the Jansen Potash Project was first filed as an exhibit to BHP's annual report on Form 20-F for the year ended 30 June 2022, effective 30 June 2022, as supplemented in an exhibit to BHP's annual report on Form 20-F for the year ended 30 June 2023. This Technical Report Summary is an update of the previously filed Technical Report Summary.

### 3 Property Description

#### 3.1 Property Location

The Jansen Potash Project is located in the Rural Municipalities of Leroy and Prairie Rose in Central Saskatchewan, Canada, approximately 150 kilometres east of the city of Saskatoon. The Legal Land Description of the Shafts and future surface plant is Section 12 Township 34 Range 20 West of 2<sup>nd</sup> Meridian. The project is easily accessible by public highways. The general location is shown on the map in Figure 3-1.

The Jansen Mine service shaft location details are found in Table 3-1.

**Table 3-1: Jansen Service Shaft Coordinates**

Co-ordinates	
Longitude	104°42'53.44"W
Latitude	51°53'56.62"N
Collar Elevation	544 metres above sea level
Northing	5,749,850
Easting	519,620
Projection	UTM
Datum	NAD83
Zone	13

For personal use only

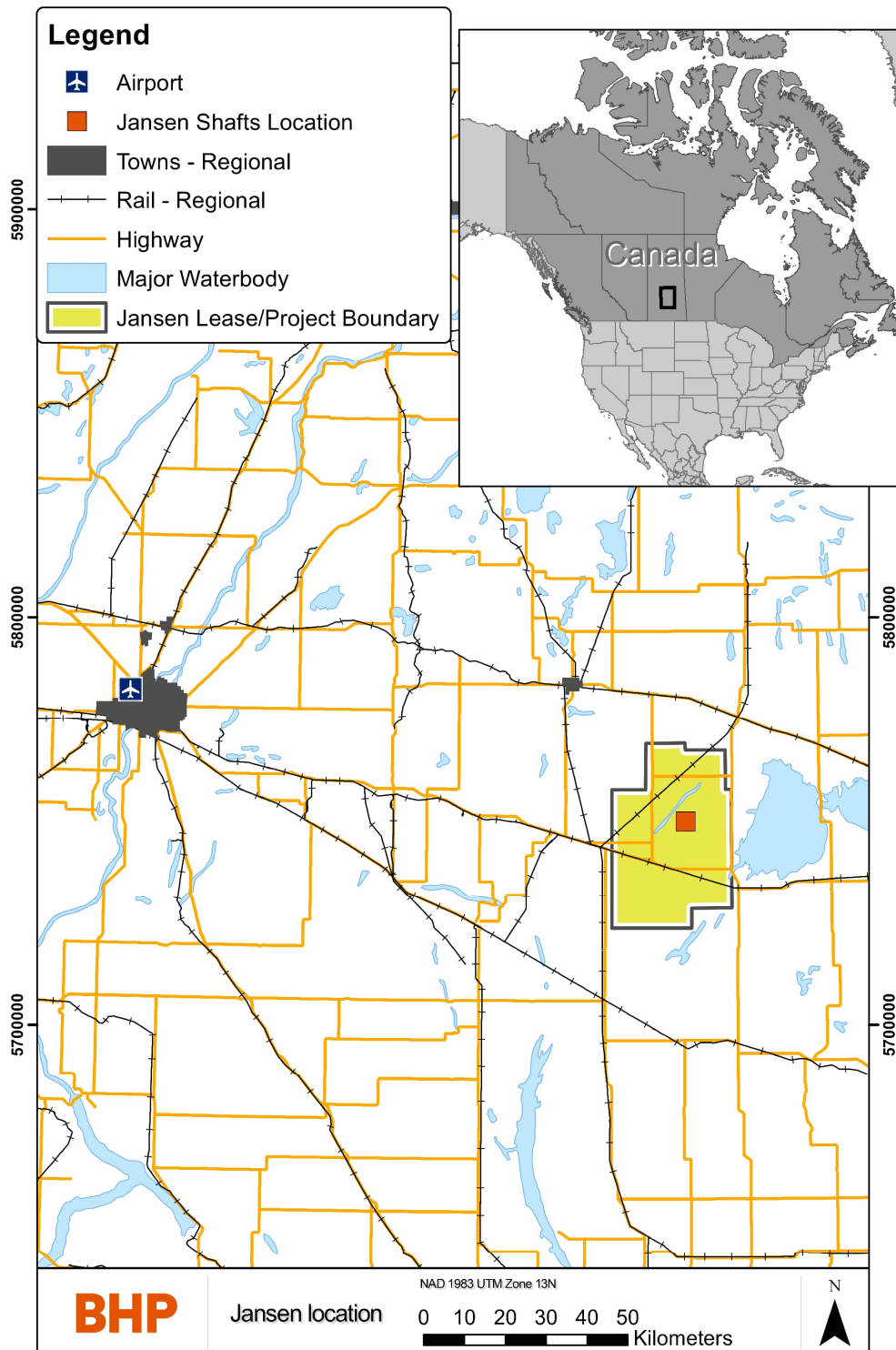

**Figure 3-1: Location Map of Jansen**

### 3.2 Mineral Tenure

The total area of the Jansen Project lease is approximately 1,156 square kilometres. Most mineral rights parcels are owned by the Saskatchewan Crown, the remaining mineral parcels are owned by individuals and/or corporations (Figure 3-2). The annual mineral lease rental payments payable to the Government of Saskatchewan and private individuals or corporations are listed in Table 3-2.

Table 3-2: Jansen Main Lease Areas and associated payments

Lease Number	Lease Holder	Expiration Date	Area (Ha)	Annual Rental Payment CA\$
KLSA 011	BHP Canada Inc.	22/11/2033	105,662.36	1,056,623.66
DSP-MRA-JANSEN-ML-000649	BHP Canada Inc.	15/08/2033	129.69	640.94
DSP-MRA-JANSEN-ML-000366	BHP Canada Inc.	07/11/2033	63.94	316
DSP-MRA-JANSEN-ML-000512	BHP Canada Inc.	13/06/2033	97.88	483.7
DSP-MRA-JANSEN-ML-000556	BHP Canada Inc.	23/07/2033	129.36	639.3
DSP-MRA-JANSEN-ML-000703	BHP Canada Inc.	05/11/2033	128.89	636.96
DSP-MRA-JANSEN-ML-000557	BHP Canada Inc.	23/07/2033	129.74	641.16
DSP-MRA-JANSEN-ML-000686	BHP Canada Inc.	07/05/2033	64.67	319.58
DSP-MRA-JANSEN-ML-000603	BHP Canada Inc.	24/09/2030	56.66	280
DSP-MRA-JANSEN-ML-000606	BHP Canada Inc.	24/09/2030	56.66	280
DSP-MRA-JANSEN-ML-000516	BHP Canada Inc.	03/06/2033	16.09	79.52
DSP-MRA-JANSEN-ML-000665	BHP Canada Inc.	27/02/2034	0.40	2
DSP-MRA-JANSEN-ML-000518	BHP Canada Inc.	30/04/2033	16.18	79.96
DSP-MRA-JANSEN-ML-000491	BHP Canada Inc.	30/04/2033	16.18	79.96
DSP-MRA-JANSEN-ML-000502	BHP Canada Inc.	27/05/2033	64.67	319.58
DSP-MRA-JANSEN-ML-000662	BHP Canada Inc.	13/02/2034	60.76	300.3
DSP-MRA-JANSEN-ML-000673	BHP Canada Inc.	04/04/2033	2714.80	13416.56
DSP-MRA-JANSEN-ML-000195	BHP Canada Inc.	10/05/2032	32.17	159
DSP-MRA-JANSEN-ML-000196	BHP Canada Inc.	10/05/2032	32.17	159
DSP-MRA-JANSEN-ML-000191	BHP Canada Inc.	10/05/2032	32.17	159
DSP-MRA-JANSEN-ML-000192	BHP Canada Inc.	10/05/2032	32.17	159
DSP-MRA-JANSEN-ML-000193	BHP Canada Inc.	10/05/2032	32.17	159
DSP-MRA-JANSEN-ML-000194	BHP Canada Inc.	10/05/2032	32.17	159
DSP-MRA-JANSEN-ML-000525	BHP Canada Inc.	25/07/2033	64.81	320.3
DSP-MRA-JANSEN-ML-000504	BHP Canada Inc.	14/06/2033	64.94	320.92
DSP-MRA-JANSEN-ML-000680	BHP Canada Inc.	13/03/2035	258.18	1275.94
DSP-MRA-JANSEN-ML-000593	BHP Canada Inc.	20/11/2033	12.72	62.88
DSP-MRA-JANSEN-ML-000363	BHP Canada Inc.	23/04/2033	10.84	53.58
DSP-MRA-JANSEN-ML-000604	BHP Canada Inc.	30/05/2031	64.75	320
DSP-MRA-JANSEN-ML-000561	BHP Canada Inc.	24/09/2033	63.81	315.34
DSP-MRA-JANSEN-ML-000501	BHP Canada Inc.	15/06/2033	193.61	956.84
DSP-MRA-JANSEN-ML-000608	BHP Canada Inc.	14/10/2033	64.84	320.44
DSP-MRA-JANSEN-ML-000492	BHP Canada Inc.	19/04/2033	10.84	53.58
DSP-MRA-JANSEN-ML-000514	BHP Canada Inc.	05/04/2033	64.41	318.32
DSP-MRA-JANSEN-ML-000655	BHP Canada Inc.	16/04/2033	31.95	157.88
DSP-MRA-JANSEN-ML-000520	BHP Canada Inc.	15/06/2033	130.00	642.44
DSP-MRA-JANSEN-ML-000759	BHP Canada Inc.	16/01/2034	32.44	160.32
DSP-MRA-JANSEN-ML-000650	BHP Canada Inc.	05/01/2034	0.40	2
DSP-MRA-JANSEN-ML-000656	BHP Canada Inc.	03/01/2034	0.40	2
DSP-MRA-JANSEN-ML-000653	BHP Canada Inc.	05/01/2034	0.40	2
DSP-MRA-JANSEN-ML-000847	BHP Canada Inc.	20/06/2034	63.19	312.28
DSP-MRA-JANSEN-ML-000651	BHP Canada Inc.	12/12/2033	16.09	79.52
DSP-MRA-JANSEN-ML-000503	BHP Canada Inc.	03/06/2033	16.09	79.52
DSP-MRA-JANSEN-ML-000370	BHP Canada Inc.	23/05/2033	64.72	319.86
DSP-MRA-JANSEN-ML-000559	BHP Canada Inc.	23/04/2033	129.75	641.24
DSP-MRA-JANSEN-ML-000449	BHP Canada Inc.	05/03/2033	129.74	641.16
DSP-MRA-JANSEN-ML-000685	BHP Canada Inc.	09/04/2035	60.59	299.44
DSP-MRA-JANSEN-ML-000447	BHP Canada Inc.	03/05/2033	126.96	627.46
DSP-MRA-JANSEN-ML-000657	BHP Canada Inc.	28/03/2033	65.11	321.76
DSP-MRA-JANSEN-ML-000508	BHP Canada Inc.	23/07/2033	64.88	320.64
DSP-MRA-JANSEN-ML-000658	BHP Canada Inc.	12/12/2033	12.72	62.88
DSP-MRA-JANSEN-ML-000506	BHP Canada Inc.	01/05/2033	65.03	321.36
DSP-MRA-JANSEN-ML-000497	BHP Canada Inc.	30/04/2033	32.48	160.5
DSP-MRA-JANSEN-ML-000496	BHP Canada Inc.	17/02/2033	63.86	315.6
DSP-MRA-JANSEN-ML-000740	BHP Canada Inc.	19/03/2033	159.86	790.04
DSP-MRA-JANSEN-ML-000605	BHP Canada Inc.	16/09/2031	11.53	57

For personal use only

<b>DSP-MRA-JANSEN-ML-000777</b>	BHP Canada Inc.	06/08/2033	16.22	80.14
<b>DSP-MRA-JANSEN-ML-000535</b>	BHP Canada Inc.	19/07/2033	48.67	240.52
<b>DSP-MRA-JANSEN-ML-000616</b>	BHP Canada Inc.	19/08/2033	16.22	80.14
<b>DSP-MRA-JANSEN-ML-000494</b>	BHP Canada Inc.	18/03/2033	63.82	315.42
<b>DSP-MRA-JANSEN-ML-000513</b>	BHP Canada Inc.	19/03/2033	0.84	4.14
<b>DSP-MRA-JANSEN-ML-000737</b>	BHP Canada Inc.	06/11/2035	0.57	2.8
<b>DSP-MRA-JANSEN-ML-000711</b>	BHP Canada Inc.	03/04/2034	128.78	636.44
<b>DSP-MRA-JANSEN-ML-000510</b>	BHP Canada Inc.	26/03/2033	32.46	160.44
<b>DSP-MRA-JANSEN-ML-000742</b>	BHP Canada Inc.	19/04/2033	32.46	160.4
<b>DSP-MRA-JANSEN-ML-000536</b>	BHP Canada Inc.	22/07/2033	16.09	79.52
<b>DSP-MRA-JANSEN-ML-000601</b>	BHP Canada Inc.	13/05/2031	32.38	160
<b>DSP-MRA-JANSEN-ML-000602</b>	BHP Canada Inc.	13/05/2031	32.38	160
<b>DSP-MRA-JANSEN-ML-000652</b>	BHP Canada Inc.	17/12/2033	12.72	62.88
<b>DSP-MRA-JANSEN-ML-000668</b>	BHP Canada Inc.	24/03/2034	32.46	160.4
<b>DSP-MRA-JANSEN-ML-000738</b>	BHP Canada Inc.	21/02/2034	12.72	62.88
<b>DSP-MRA-JANSEN-ML-000715</b>	BHP Canada Inc.	12/12/2033	12.72	62.88
<b>DSP-MRA-JANSEN-ML-000564</b>	BHP Canada Inc.	15/04/2033	64.58	319.16
<b>DSP-MRA-JANSEN-ML-000365</b>	BHP Canada Inc.	15/04/2033	32.28	159.54
<b>DSP-MRA-JANSEN-ML-000666</b>	BHP Canada Inc.	27/02/2034	0.40	2
<b>POT-Jansen-ML-000848</b>	BHP Canada Inc.	17/05/2033	65.05	321.46

For personal use only

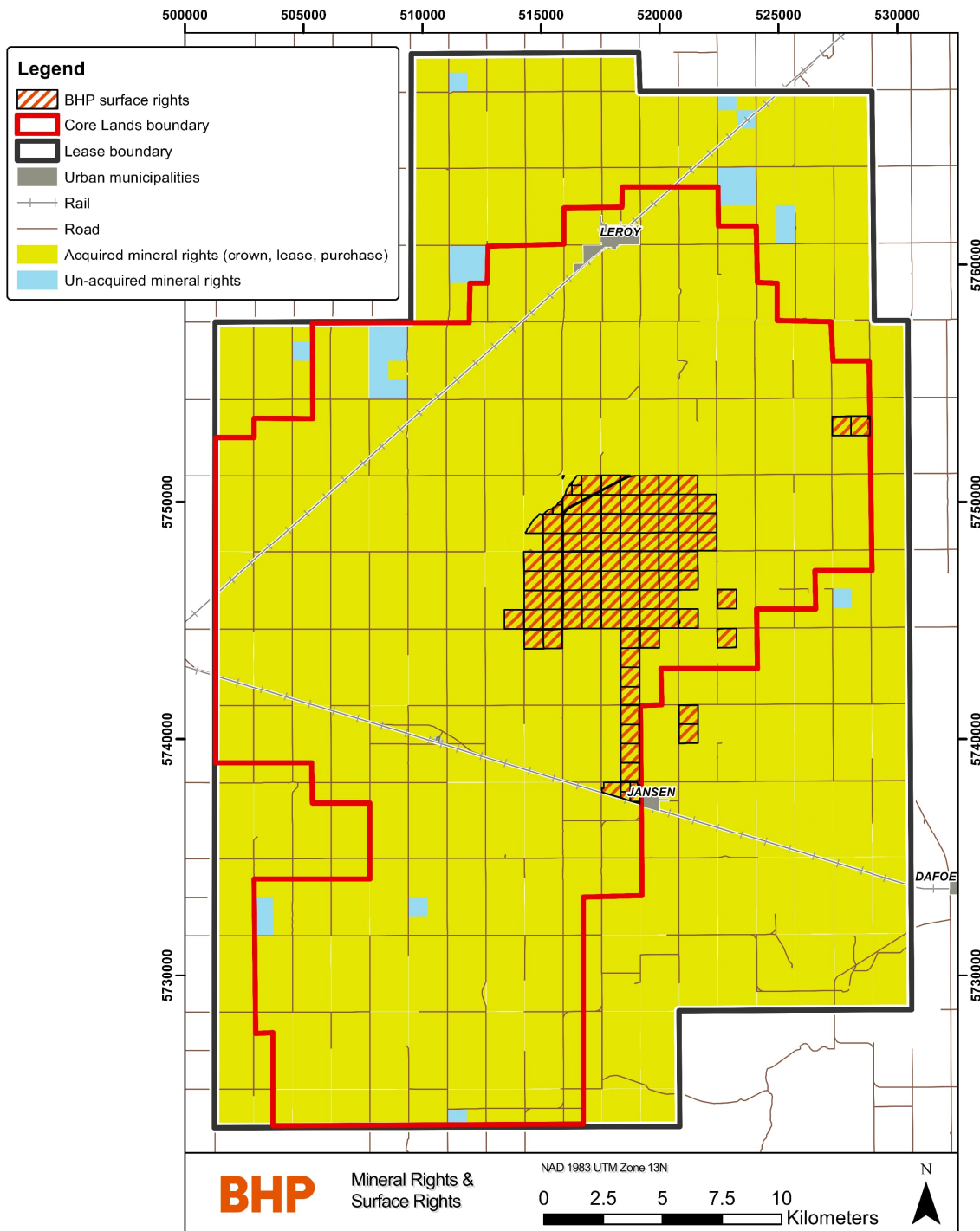

**Figure 3-2: Lease Areas of Jansen**

### 3.3 Mineral Rights Description

On 23 November 2012, the Government of Saskatchewan and BHP Canada entered into Potash Lease Special Agreement KLSA 011. This agreement gives BHP Canada the exclusive right to search for, dig, work, mine, extract, recover, process, and carry away subsurface minerals under or within all of the Saskatchewan Crown mineral parcels of KLSA 011. The lease pertains to two categories of lands, shown in Figure 3-2 and consisting of:

1. 'KLSA 011 Core Lands' comprising primarily the Mineral Reserves

For personal use only



2. 'KLSA 011 Expansion Lands', and additional area outside Mineral Reserves that includes the primarily Inferred Resource.

To gain access to the potash within mineral parcels owned by individuals and/or corporations ('freehold mineral lease'), BHP must either purchase the mineral parcels or negotiate mineral lease agreement(s) with the registered owner(s) of the mineral parcel(s). The freehold mineral leases secured by BHP Canada have a term of twenty-one years and are renewable at the option of BHP for successive terms of twenty-one years each. An annual rental payment of CA\$4.94/hectare (CA\$2/acre) is also paid to keep these leases in good standing.

During the first three years of the KLSA 011 lease, BHP Canada was required to complete CA\$12M of work on the lease area. This work commitment has been met using excess exploration work credits completed on the exploration permits prior to the Jansen exploration permits conversion to KLSA 011.

All surface lands that form part of the Jansen mine operations footprint have been acquired by BHP Canada. The total surface area acquired by BHP Canada is shown in Figure 3-2.

**Table 3-3: Summary of Jansen land position**

Jansen Mineral Rights details				
	Area Hectares	Area Acres	Area km <sup>2</sup>	%
Jansen project total lease area	115638	285747	1156.38	100
KLSA 011 Core lands	63939.43	157997.78	639.39	55
KLSA 011 Expansion lands	41724.73	103104.06	417.25	36
BHP Canada acquired freehold mineral rights	8997.56	22233.45	89.98	8
Total of Core, Expansion, and acquired freehold mineral rights	<b>114661.72</b>	<b>283335.29</b>	<b>1146.62</b>	<b>99</b>

### 3.4 Encumbrances

There have been no significant encumbrances to the property identified as of the date of this report. Federal, provincial and municipal permits and approval for construction and operation have been received. All material permits that have been applied for to-date have been received. Based on the Life of Asset (LoA) Plan additional permits and approvals will become necessary. The Qualified Person believe that Jansen will reasonably be able to obtain the required construction and operation permits for the Project based on the LoA Plan.

### 3.5 Other Significant Factors and Risks

It is the opinion of the Qualified Person that based on the available information and current regulations there are no significant risks to the mineral tenure that would affect access or mineral title and the ability of BHP to work on the property.

### 3.6 Royalties or Similar Interest

A Provincial Potash Crown Royalty is payable under *The Subsurface Mineral Royalty Regulations, 2017*. Royalties are based on the value of potash produced from Crown mineral lands. The royalty rate is 3 per cent, and the value is determined as the average price realized by the producer in the year, as governed by revenues and sales under *The Saskatchewan Potash Production Tax Regulations*.

For personal use only

## 4 Accessibility, Climate, Local Resources, Infrastructure, and Physiography

### 4.1 Topography, Elevation, and Vegetation

The topography of the Jansen site is generally flat with elevations that range between 540 metres and 545 metres. The site slopes 0.3 per cent from northwest to southeast. The site is composed of agricultural fields, with patches of trees and small wetlands. Non-contact runoff water collects in a wetland area to the east of the site, then drains to Hatke Lake approximately 10 kilometres northeast of the site. Jansen Lake and Lanigan Creek are located northwest of the Hatke Lake drainage basin.

### 4.2 Means of Access

The site is accessed by road from provincial Highway 16 approximately 12 kilometres to the south and Highway 5 approximately 32 kilometres to the north. Access to the site from these highways will use upgraded secondary and/or primary roads from the village of Jansen to the south and the town of LeRoy to the north. Railway access is expected to be available from both national rail networks and will be from a spur line from the south (Figure 3-2) and be subject to future applications and agreements.

### 4.3 Climate and Length of Operating Season

The Jansen area experiences a climate which is typical of the Canadian prairies: a humid continental climate (Köppen climate classification – Dfb) featuring long, cold winters and brief, warm summers. High temperatures range from 15°C in May to the mid-30s°C in July and August with moderate precipitation. Winter normally begins in November and temperatures generally remain below the freezing point. In cold snaps temperatures may drop as low as -40s°C. Mild spring weather usually begins by April. Annual precipitation averages 30 to 45 centimetres. Operations can continue throughout the year.

### 4.4 Infrastructure and Availability

On-site infrastructure is expected to include power distribution, raw water storage and distribution, potable water treatment, fire water distribution, diesel fuel storage and distribution, natural gas distribution, ancillary buildings and facilities, Tailings Management Area (TMA), sewage system, waste collection, site drainage, on-site roads, on-site rail, communications and technology infrastructure, the process control system, and the temporary construction facilities. On-site utilities are expected to be distributed in a combination of pre-cast trenches, direct buried cables, and buried pipes for water, sanitary effluent, and natural gas. Diesel fuel is expected to be delivered to site and stored in a contained area. Fuel for the mining equipment is expected to be delivered underground by totes using the service shaft.

Operations facilities are expected to consist of the administration building (containing the mill and mine dry, offices, training, and security), warehousing, maintenance workshop, vehicle maintenance facility, emergency response facility, mill support facility, laboratory, compressor building, rail support facility and main water pump house.

Off-site infrastructure for the Jansen Project is executed through contractual agreements with third parties using defined battery limits on the project site. Off-site utilities are provided by the

Crown corporations of the Province of Saskatchewan (i.e., SaskPower, TransGas and SaskEnergy, SaskWater, and SaskTel). All public roads in Saskatchewan are owned by the Crown in right of Saskatchewan. Rural municipalities have authority to direct, control, and manage the roads within their municipality.

#### 4.5 Water

The raw water system consists of the incoming water supply line from SaskWater and groundwater sourced from the existing Raw Water Well 1 (RWW 1). Primary water supply will be surface water from the Saskatoon South East Water Supply (SSEWS) system delivered by pipeline from the Zelma Reservoir to the site by SaskWater. Based on available information, the capacity of the water supply pipeline is expected to be 7M m<sup>3</sup>/y for the Jansen project. The SaskWater line has a capacity of 9.2M m<sup>3</sup>/y and supplies other consumers besides the Jansen Project. Back-up non-process water supply will be sourced from the Empress Group Aquifer through the constructed on-site RWW 1.

#### 4.6 Electricity

Permanent power is contracted to be supplied by SaskPower using 230 kV overhead lines terminating at the 230 kV main plant substation dead-end structure (the point of common coupling). The permanent 230 kV power supply has been constructed and commissioned to the Jansen site.

#### 4.7 Personnel

Employees of Jansen mine are anticipated to reside in several existing communities located in the area. The potash mining industry has a long history of providing employment in the province and communities within driving distance of the site are in the process of preparing for the growth brought on by investment decisions to further develop Jansen.

#### 4.8 Supplies

The Jansen project is connected to a primary weight, asphalt surface network of highways and has year-round access for trucking of materials to/from the site. On-site warehousing will be provided to manage inventory requirements of the operating mine. In addition to road access there will be connections to both of the major rail providers in Canada.

## 5 History

### 5.1 Previous Operations

The Saskatchewan potash basin has a long history of exploration and mining operations since the 1950s. BHP will be the first mining operation owner at the Jansen location.

### 5.2 Exploration and Development by Previous Owners or Operators

The Potash Company of America initiated potash exploration work in the Jansen area in 1952. Alwinal Potash of Canada followed this with further work in 1959. Kerr-McGee Oil Industries Inc. carried out the main historical exploration phase between September 1962 and October 1965. The period 1965 to 2005 saw no further significant exploration activities for potash in the Jansen area. In 2005, Anglo Minerals Ltd., a small junior company registered an extensive land package of potash exploration permits surrounding the producing Potash mines in the Saskatoon area, which included the Jansen project area.

In September 2005, Anglo Minerals Ltd. published a Canadian National Instrument (NI 43-101) report based on historical drilling, which included a resource estimate for exploration permit KP286 only, (Halabura et al. 2005). A small 3D seismic survey was completed from October 2005 to March 2006 for the part of Jansen area. An additional NI 43-101 report, which included the results of the 3D seismic and covered KP285, KP286, and KP290, was issued in November 2006 (Halabura and Gebhardt, 2006).

Kerr-McGee Oil Industries Inc. drilled all the historical holes on the Jansen Project, except for two (07-01 and 07-06), during the period from September 1962 to October 1965. The earliest two holes were drilled by the Potash Company of America Limited in December 1952 (07-01) and Alwinal Potash of Canada Limited in June 1959 (07-06). Table 5-1 shows the full list of historical holes.

**Table 5-1: Summary of exploration drilling by previous owners**

BHP ID	CWI	DRILL HOLE TYPE	Owner	Easting (m)	Northing (m)	KB elevation (m)	TOTAL DEPTH (m)	HOLE DIP
07-01	SK0001200	Historic exploration	Potash Company of America Ltd.	504598.4	5739717.0	539	996.7	Vertical
07-02	SK0011162	Historic exploration	Kerr-McGee Oil Industries Inc.	506560.6	5744544.0	538	993.6	Vertical
07-03	SK0011129	Historic exploration	Kerr-McGee Oil Industries Inc.	502979.1	5746198.5	542	1002.8	Vertical
07-04	SK0009464	Historic exploration	Kerr-McGee Oil Industries Inc.	506262.8	5747138.5	537	973.8	Vertical
07-05	SK0011265	Historic exploration	Kerr-McGee Oil Industries Inc.	506225.2	5749925.5	544	982.7	Vertical
07-06	SK0007349	Historic exploration	Alwinal Potash of Canada Ltd.	502991.2	5756045.5	551	1033.6	Vertical
08-01	SK0011401	Historic exploration	Kerr-McGee Oil Industries Inc.	520908.5	5749484.5	544	964.7	Vertical
08-03	SK0012931	Historic exploration	Kerr-McGee Oil Industries Inc.	523917.4	5754314.5	541	938.5	Vertical
08-04	SK0011508	Historic exploration	Kerr-McGee Oil Industries Inc.	520847.4	5754837.0	540	935.7	Vertical
08-05	SK0004216	Historic exploration	Kerr-McGee Oil Industries Inc.	520626.1	5732004.0	529	1025	Vertical

BHP ID	CWI	DRILL HOLE TYPE	Owner	Easting (m)	Northing (m)	KB elevation (m)	TOTAL DEPTH (m)	HOLE DIP
08-08	SK0009433	Historic exploration	Kerr-McGee Oil Industries Inc.	514190.5	5743747.5	550	990	Vertical
08-09	SK0011403	Historic exploration	Kerr-McGee Oil Industries Inc.	517441.4	5743801.0	544	990.6	Vertical
08-10	SK0011482	Historic exploration	Kerr-McGee Oil Industries Inc.	519061.4	5745531.0	544	977.8	Vertical
08-11	SK0011267	Historic exploration	Kerr-McGee Oil Industries Inc.	519060.1	5747989.5	546	978.1	Vertical
08-12	SK0011383	Historic exploration	Kerr-McGee Oil Industries Inc.	515813.7	5747978.0	547	978.4	Vertical
08-13	SK0011128	Historic exploration	Kerr-McGee Oil Industries Inc.	520687.2	5751039.0	541	957.4	Vertical
08-14	SK0011358	Historic exploration	Kerr-McGee Oil Industries Inc.	517609.3	5751220.0	547	960.7	Vertical
08-15	SK0011376	Historic exploration	Kerr-McGee Oil Industries Inc.	514644.0	5751209.5	544	981.5	Vertical
08-16	SK0011483	Historic exploration	Kerr-McGee Oil Industries Inc.	515795.3	5754604.0	546	947.9	Vertical
08-17	SK0011268	Historic exploration	Kerr-McGee Oil Industries Inc.	519360.3	5759215.0	544	935.7	Vertical
08-18	SK0010280	Historic exploration	Kerr-McGee Oil Industries Inc.	510902.5	5751009.0	542	957.4	Vertical
08-19	SK0011164	Historic exploration	Kerr-McGee Oil Industries Inc.	510928.9	5747022.0	549	991.2	Vertical
09-08	SK0005768	Historic exploration	Kerr-McGee Oil Industries Inc.	516047.1	5724592.0	533	1158.2	Vertical
09-14	SK0016476	Historic exploration	Kerr-McGee Oil Industries Inc.	504306.9	5727442.5	544	1217.7	Vertical
11-03	SK0011269	Historic exploration	Kerr-McGee Oil Industries Inc.	525569.7	5744790.0	536	951.9	Vertical
11-04	SK0016602	Historic exploration	Kerr-McGee Oil Industries Inc.	523465.3	5763933.0	543	1068.3	Vertical

Details of Kerr-McGee's drilling program are limited to available drilling reports filed with the Saskatchewan Ministry of Energy and Resources (SER). The holes were completed with either a T-22, Ideco 25 or Stratmaster 90 drilling rig.

A descriptive lithologic log of the cuttings and core is still available to view for these drill holes. Analytical samples were cut from the core of the Patience Lake (UPL and LPL) and Belle Plaine members. The split core samples were wrapped in double acetate bags and shipped to the Kerr-McGee research laboratory for analysis. In keeping with Saskatchewan government regulations, the cuttings, core and the other half of sample splits were delivered to the Subsurface Laboratory in Regina.

Drilling reports, which are available at the Saskatchewan government website, indicate that the quality and consistency of the work is very good, and the core recovery is indicated to be 100 per cent in the mineralized zone.

All geochemical analysis from all the Kerr-McGee drill holes, except the first three holes drilled prior to 1964, appears to have been completed at the same research laboratory, using the same analysis suite for every hole. For the initial three Kerr-McGee holes (i.e., 08-08, 07-04, 08-18), the analysis is restricted to K<sub>2</sub>O% and insolubles%.

## 6 Geological Setting, Mineralization, and Deposit

### 6.1 Regional Geology

The Phanerozoic sedimentary wedge covers much of western Canada (Figure 6-1). It thickens southwest from the exposed Canadian Shield to a preserved thickness of over six kilometres to the west and over three kilometres to the south. This sediment cover is divided into several intracratonic basins, including the Liard Basin, Alberta Basin, and Williston basin. The Canadian segment of this sediment cover is also known as the Western Canadian Sedimentary Basin (WCSB).

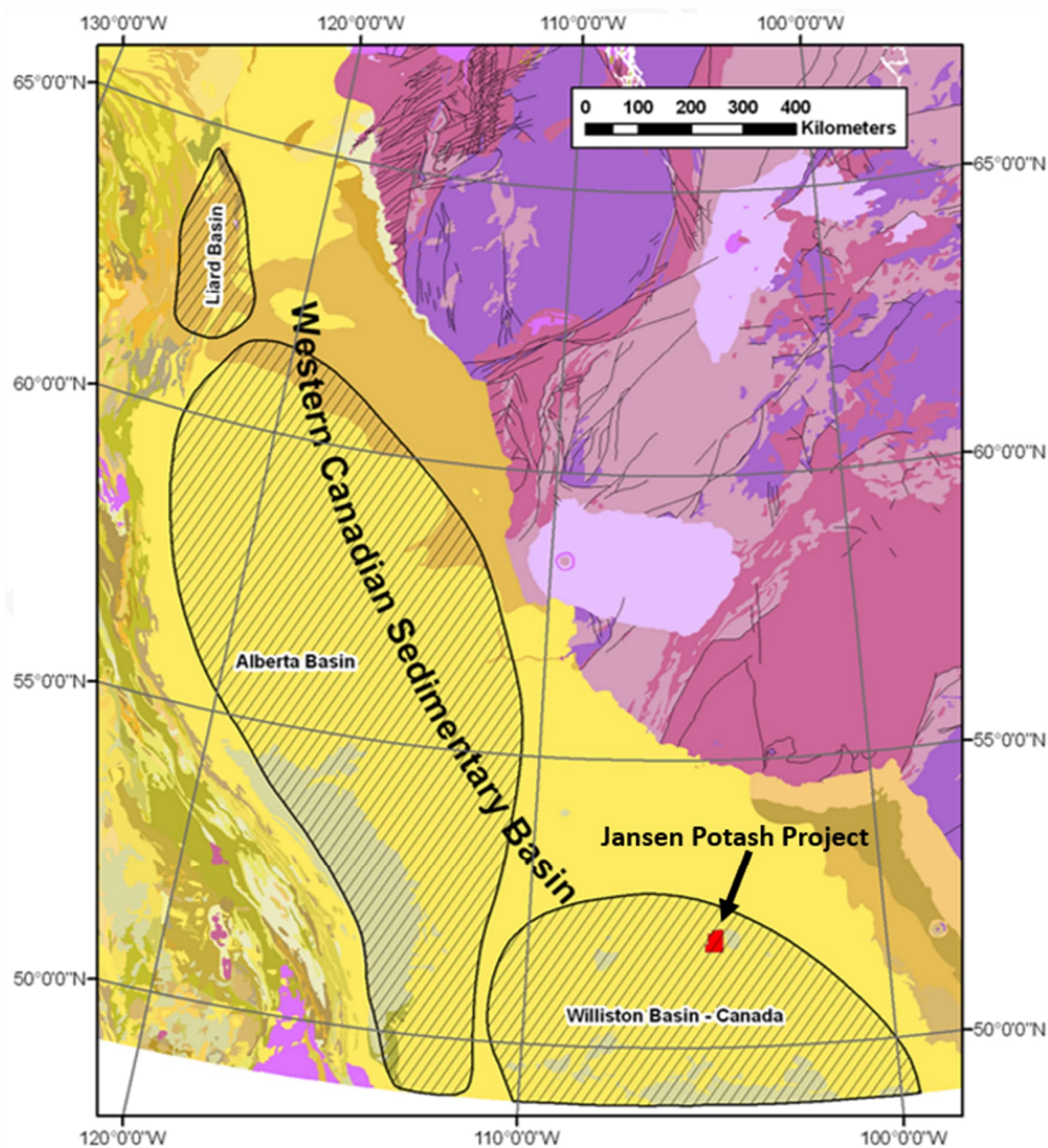

Figure 6-1: Regional Geology Map – Western Canadian Sedimentary Basin (Geological Map of Canada – Geological Survey of Canada).

### 6.2 Local Geology

During the Middle Devonian period, the Alberta Basin and the Williston Basin formed one larger unit, the Elk Point Basin, which was connected to the ocean in the northwest (Figure 6-1). Later,

For personal use only

basin restrictions began to increase its salinity and induced the deposition of the Prairie Evaporite (PE) which hosts the potash bearing members. Middle Devonian cyclic deposition continued with Manitoba Group and Saskatchewan Group after the Elk Point Group sediments.

The Jansen potash deposit is located within the Williston Basin, a large, intracratonic, structurally simple, and horizontally bedded sedimentary basin. The Williston Basin extends from southern Saskatchewan, Canada into the northern states of the United States of America. Figure 6-2 shows the extents of potash distribution with the Williston Basin.

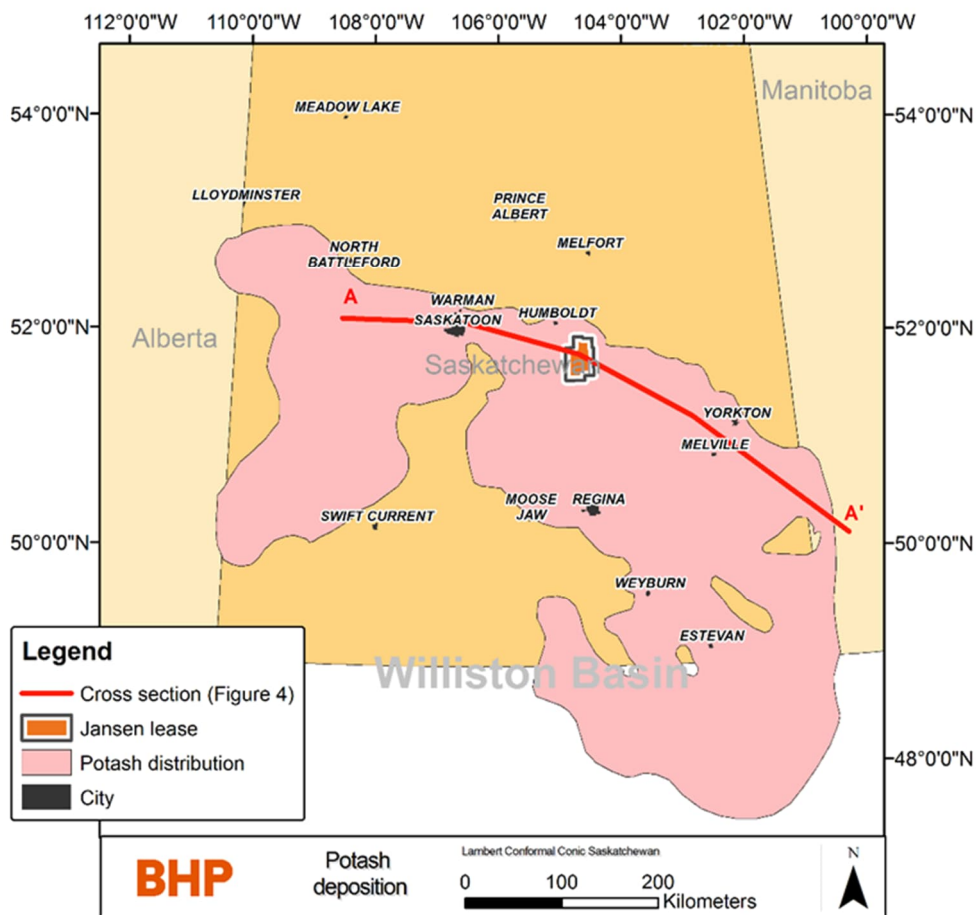

**Figure 6-2: Map of potash distribution within the Williston Basin (modified from Fuzesy (1982))**

Deposition of sediments in the basin began during the Cambrian geological time period, followed by an intense period of limestone, dolomite, evaporite, sandstone, and shale deposition during the geological time periods Ordovician, Silurian, and Devonian ending with Cretaceous sediments. Figure 6-3 shows a schematic cross section focused on members of interest in the Jansen area, location of the cross-section A-A' shown in Figure 6-2.

For personal use only

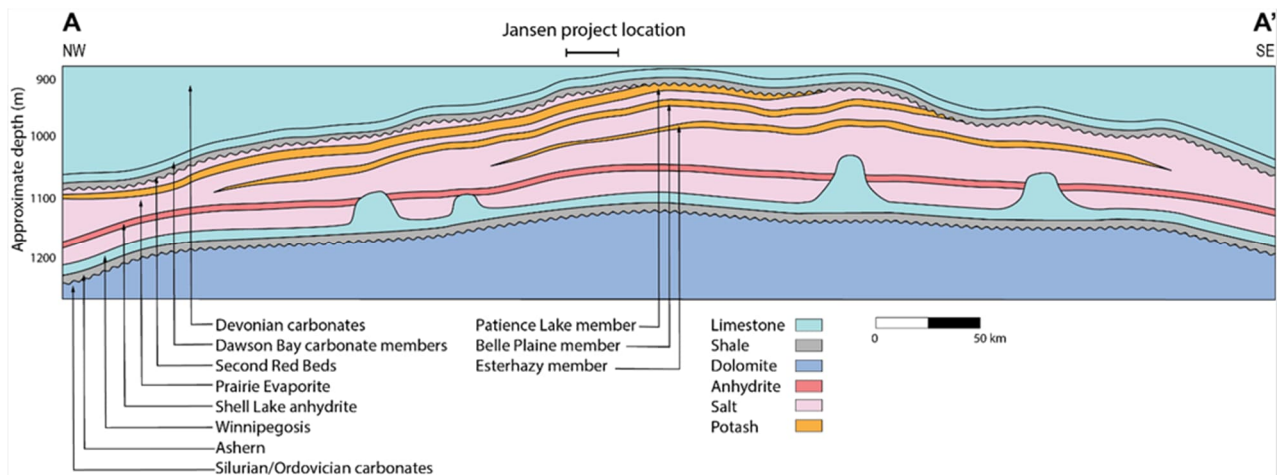

**Figure 6-3: Schematic geological section showing the potash members of the Prairie Evaporite Formation. The location of the section is shown on Figure 6-2:**

Figure 6-4 shows the full stratigraphic column from surface, including the key members for the Jansen potash project area.

For personal use only



For personal use only

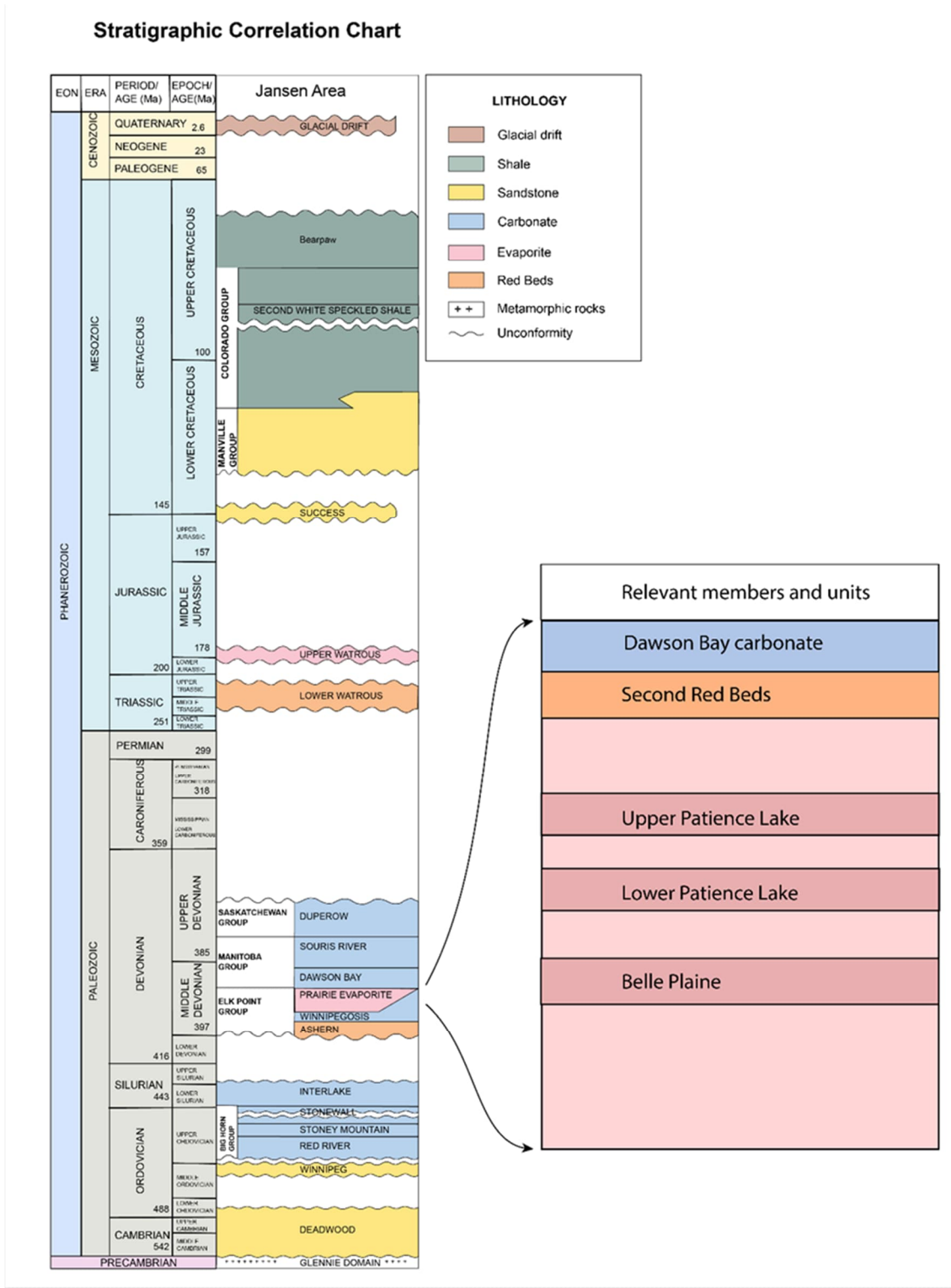

Figure 6-4: Stratigraphic column for the Jansen area (after Stratigraphic Correlation Chart economy.gov.sk.ca, 2016).

### 6.3 Property Geology

There is no visible rock outcrop at Jansen, the property is relatively flat open Prairie type farm land and a thick layer (100+ metres) of glacial drift deposits over lie the Cretaceous age, shale of the Bearpaw Formation (Figure 6-4). The potash beds are approximately 900 metres below surface, at the top of the Prairie Evaporite Formation which conformably overlies the predominantly carbonate layers of the Winniepegosis Formation. There are three main potash

bearing members present in the Prairie Evaporite Formation. Two are present in the Jansen area, those being the Patience Lake and Belle Plaine members. The Patience Lake Member is further subdivided into UPL and LPL sub-members (Figure 6-4 and Figure 6-5). The LPL sub-member is the potash horizon targeted for Jansen. These potash members were deposited in regionally extensive (hundreds of kilometres), horizontal layers during the repeated, cyclical periods of evaporation of a shallow, inland sea during the Devonian Period. Mineralization within the potash layers consists of a layered, repetitive sequence of sylvite (KCl) with halite (NaCl) and thin layers of insoluble dolomitic clay material (clay seams). Carnallite (KCl.MgCl<sub>2</sub>.6H<sub>2</sub>O), a mineral which can impact processing and ground stability, occasionally occurs in place of sylvite within the potash layer.

The Dawson Bay Formation includes the Second Red Beds and the Dawson Bay carbonate members on top and overlays the Prairie Evaporite Formation (Figure 6-4).

Approximately 400 metres below the Prairie Evaporite Formation are the Cambrian-Ordovician Winnipeg and Deadwood formations. Sediments of these formations were deposited in near shore, shallow water marine environments on top of the Precambrian rocks. The coarse to fine sands of the formations, host a vast deep saline aquifer that is used for brine disposal.

### 6.4 Mineral Deposit

The Jansen LPL sub-member is hosted within the Prairie Evaporite Formation, and was deposited in regionally extensive, horizontal layers during the repeated, cyclical evaporation of a shallow, saltpan environment during the Devonian period. LPL potash is composed of combinations of halite (NaCl), sylvite (KCl) with variable amounts of disseminated insolubles and clay seams (Figure 6-5). The LPL is subdivided into four mineralization cycles for detailed geological characterization of the potential mining horizon. The LPL sub-member is an approximately five metres thick potash unit interspersed with thin clay seams. The LPL top is marked by a clay seam (named the 406) that is overlain by an approximately 2.5 metres thick halite unit. The bottom of the LPL unit is marked by a clay seam (named the 401). The mineralization of the LPL is restricted to the 406 to 401 interval. The clay seams are consistent throughout the potash basin and the Jansen area and can be easily correlated between the drill holes.

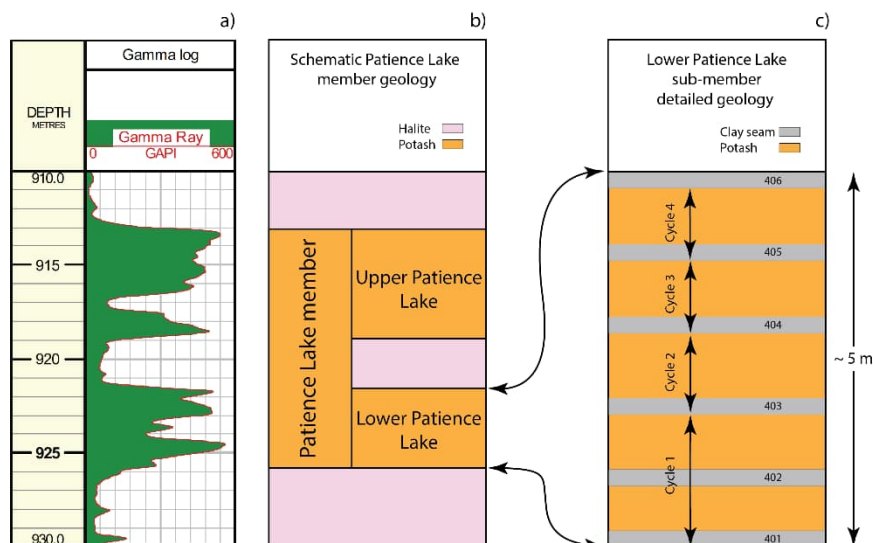

Figure 6-5: Detailed stratigraphy of the Patience Lake Member.

Safe mining practice in the Prairie Evaporite Formation requires a competent rock immediately above the top of the LPL sub-unit. The interval between the 406 and 407 clay seams, mainly consists of halite with some minor insoluble bands, traditionally known as the Shadow band (SB) and Henry Marker (HM). These are considered potential geotechnical hazards as they, in some areas, weaken the mining roof and may require extra ground support or additional cutting and increase the dilution. Their effect was taken into account in reserve calculations.

The Saskatchewan potash deposit is an example of a potash hosting evaporite sequence. This large and flat deposit extends from east to west in the province and shows relative uniformity, except where there are anomalies due to local dissolutions of the potash beds or clay seams. There is also no faulting at the level of the potash beds.

The main types of anomalies defined by Mackintosh and McVittie (1983) are called washout, leach and collapse anomalies. The generic classification is still valid, although the anomalies can be seen with different combinations (Figure 6-6). Washout and leach anomalies are also called no-potash anomalies. Collapse anomalies are characterized by a loss of recognizable potash strata through salt dissolution, replaced by brecciated, re-cemented, and recrystallized material, with breccia blocks typically derived from the overlying strata. Diameters may range from several tens of metres up to hundreds of metres. These cylindrical structures are characterized by the complete or near complete destruction of the original geological layering, as observed on seismic data by the total or almost total loss of reflection.

Collapse anomalies have been classified based on the level of connectivity to water sources and size to help standardize the terminology. Class 1 is the highest risk class as the Prairie Evaporite Formation and overlaying carbonate units are altered and disturbed on the seismic data. Class 2 shows disturbed Devonian carbonates and Class 3 type collapse anomalies are typically restricted to the Dawson Bay Formation. During the exploration program these features are mapped using 3D seismic surveys, (see Section 7.1.4 for details).

Carnallite occurrences are also considered as anomalies. Carnallite is undesirable in the mining and processing environment. Its physical properties effect ground conditions negatively and relatively low potassium and high magnesium content can interfere with ore processing. High carnallite content areas are mapped with 3D seismic surveys and avoided in the mine plan.

The geology of the basin and its geological formations are well known from extensive exploratory drilling for hydrocarbons and minerals and from geophysical data collected since 1952. This basin wide geological information is publicly available from the Saskatchewan Geological Survey in the form of maps, cross-sections, drill hole-based formation contact identification, core from historical drill holes, and other publications. Potash exploration drill hole information is confidential for the first five years after drilling, afterwards it becomes publicly available.

It is the Qualified Person's opinion that Saskatchewan's potash deposition geology is well understood based on mining in the region for 60 years and available information. The data collected for the Jansen potash project and interpretation based on the data collected is consistent with this current understanding.

For personal use only

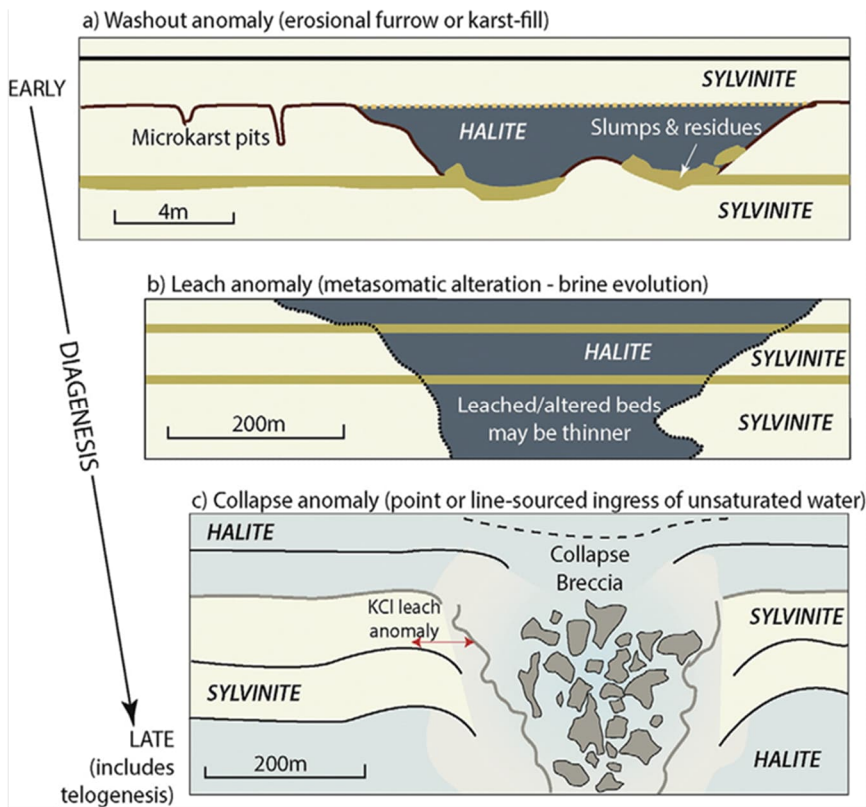

Figure 6-6: Three main types of anomalies (Mackintosh and Mc Vittie (1983)).

For personal use only

## 7 Exploration

The main exploration methods for potash in Saskatchewan are drilling and reflection seismic surveys. Drilling is typically conducted using petroleum industry rotary rigs to obtain core samples and to acquire rock property measurements with geophysical well logging tools lowered into the drill hole. Reflection seismic surveys are acquired along lines (2D) or over an area (3D) to obtain images of subsurface geology. The seismic data are used for mapping geological structures and to obtain subsurface rock physical property information. Figure 7-1 shows the potash exploration coverage, including seismic surveys and drilling.

### 7.1 Exploration Work (Other Than Drilling)

BHP Canada reflection seismic surveys include the following:

- Reconnaissance 2D seismic surveys between June 2007 and August 2007.
- Two 3D seismic surveys were completed from October 2007 to March 2008 and from October 2008 to March 2009.

#### 7.1.1 Procedures and Parameters Relating to the Surveys and Investigations

BHP Canada geophysicists and their representatives were involved in the design, planning, field acquisition, and processing of all the surveys.

Both the 2D and 3D seismic surveys are designed to provide the optimal image of the subsurface geology from the base of the Cretaceous age sediments (~ 400 metres depth) to the top of the Precambrian (~ 1,500 metres depth).

The east-west 2D survey lines are spaced 3.2 kilometres (2 miles) apart, with occasional north-south lines connecting them at approximately 20 kilometres apart. Placement of the 2D seismic survey lines utilized the grid roads established by the Dominion Land Survey system.

The 3D seismic surveys are positioned over areas that appeared to be the most prospective based on the interpretation of the 2D data. Large 3D seismic surveys are acquired in 400 to 600 square kilometre pieces over several data collection seasons. The 3D seismic survey field operations are carried out in winter, between October and March, to minimize the impact on farming and environment.

Seismic data processing history:

- The 2D survey data were first commercially processed in 2007, immediately after acquisition. In 2009, the 2D line data were re-processed with the supervision of BHP Canada geophysicists.
- The 3D seismic surveys data were processed as individual surveys, immediately after acquisition. The BHP Canada 3D seismic surveys were merged with the 2006 Anglo Minerals 3D seismic survey during processing, and the volumes were merged.
- In 2011, the three 3D seismic volumes were combined at the field data level and were reprocessed to provide one single, jointly processed time volume.

- Development in seismic processing algorithms warranted another joint re-processing in 2016. The work on this version incorporated all the learnings gained by the BHP Canada geophysicist interpreting the 2011 version.
- In 2018/2019 new processing work (Pre-Stack Depth Migration) was carried out on the joint 2016 data that provided an enhanced subsurface image volume in depth.

7.1.2 Sampling Methods and Sample Quality

Table 7-1: Seismic survey sampling

Survey	Horizontal trace spacing	Subsurface fold at Prairie Evaporite	Vertical sampling
2D	10 m along the line	~ 75	1 ms
3D	30 m both in X and Y direction	~ 15	1 ms (time volumes) 2 m (depth volumes)

The quality of the collected seismic data is continuously monitored during acquisition. This includes monitoring field equipment performance, environmental noise, and collected geographical survey information. If any parameters exceeded the defined threshold, the acquisition is stopped until the problem is fixed, or in the case of weather-related delays until conditions improve. Geographic survey information is checked and verified independently by a third-party surveying company.

The seismic data processing workflow includes further strict QA/QC steps that seek to ensure the highest possible quality results, which included among other things:

- checking source and receiver locations
- removing noisy recordings
- testing parameters for each processing step and comparing data before and after subsequent steps

Processed seismic lines/volumes at different stages of the workflow were delivered to BHP Canada’s site geophysicist for evaluation and quality checking and feedback was provided to the processors.

For personal use only

### 7.1.3 Information about the Area Covered

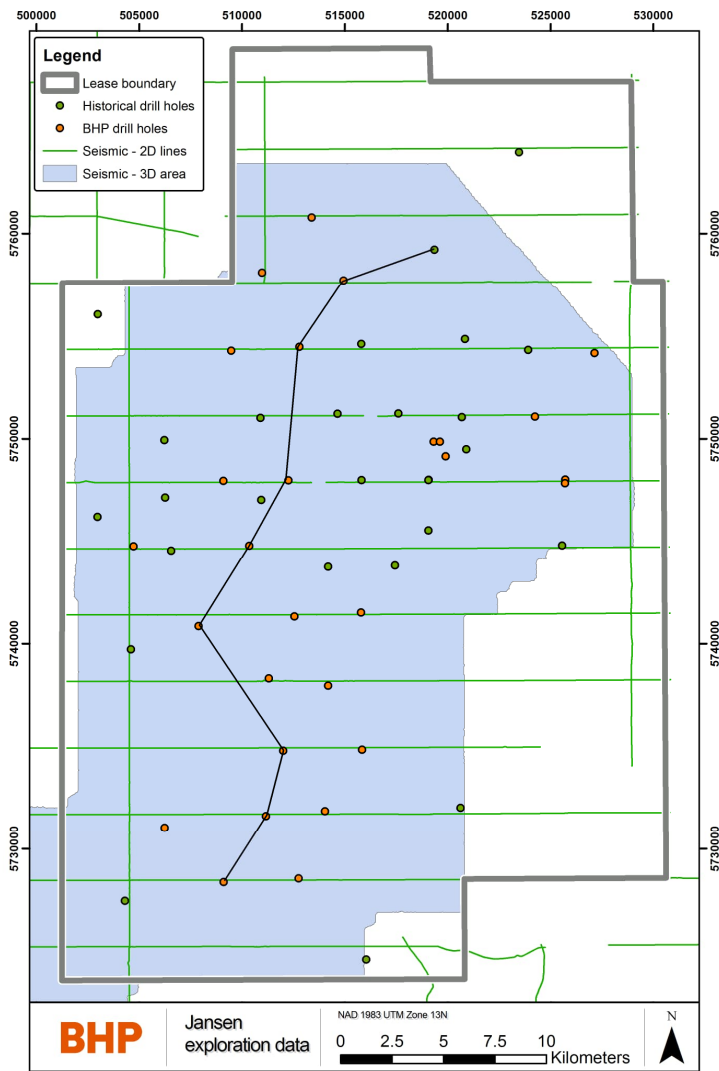

**Figure 7-1: Exploration coverage. The black line shows the location of the cross section displayed in Figure 7-5.**

The 2D seismic surveys cover the entire Jansen lease. The 3D seismic surveys cover approximately 75 per cent of the lease.

### 7.1.4 Significant Results and Interpretation

Subsurface images of the 2D seismic survey on a regional scale successfully identified areas where the detailed exploration efforts needed to be focused, away from large scale anomalous geological features and disturbed geology. The BHP Canada exploration drill holes were positioned where 2D seismic information was available to reduce the risk of drilling into disturbed geology. The 3D seismic survey was also positioned based on this information to image the most prospective areas.

The 3D seismic survey successfully imaged structural features (collapse anomalies) that pose hazards to the mining operation and were classified based on the severity of disruption that occurs in the stratigraphy (Section 6.4). Topography of major geological interfaces, for example the top of the Prairie Evaporite Formation, are also mapped (Figure 7-2).

For personal use only

Quantitative interpretation of the seismic response from the LPL zone allowed identification of anomalous geological areas located within the LPL member, i.e. carnallite and no-potash anomalies. In the Qualified Person’s opinion, the level of detail in the surveys is sufficient to enable the development of the geological model to form the basis of Mineral Resources Estimate (as detailed in Section 11 of this report). The confidence in the granularity of the surveys is sufficient to assign higher levels of classification (Measured and Indicated) between the sampling points.

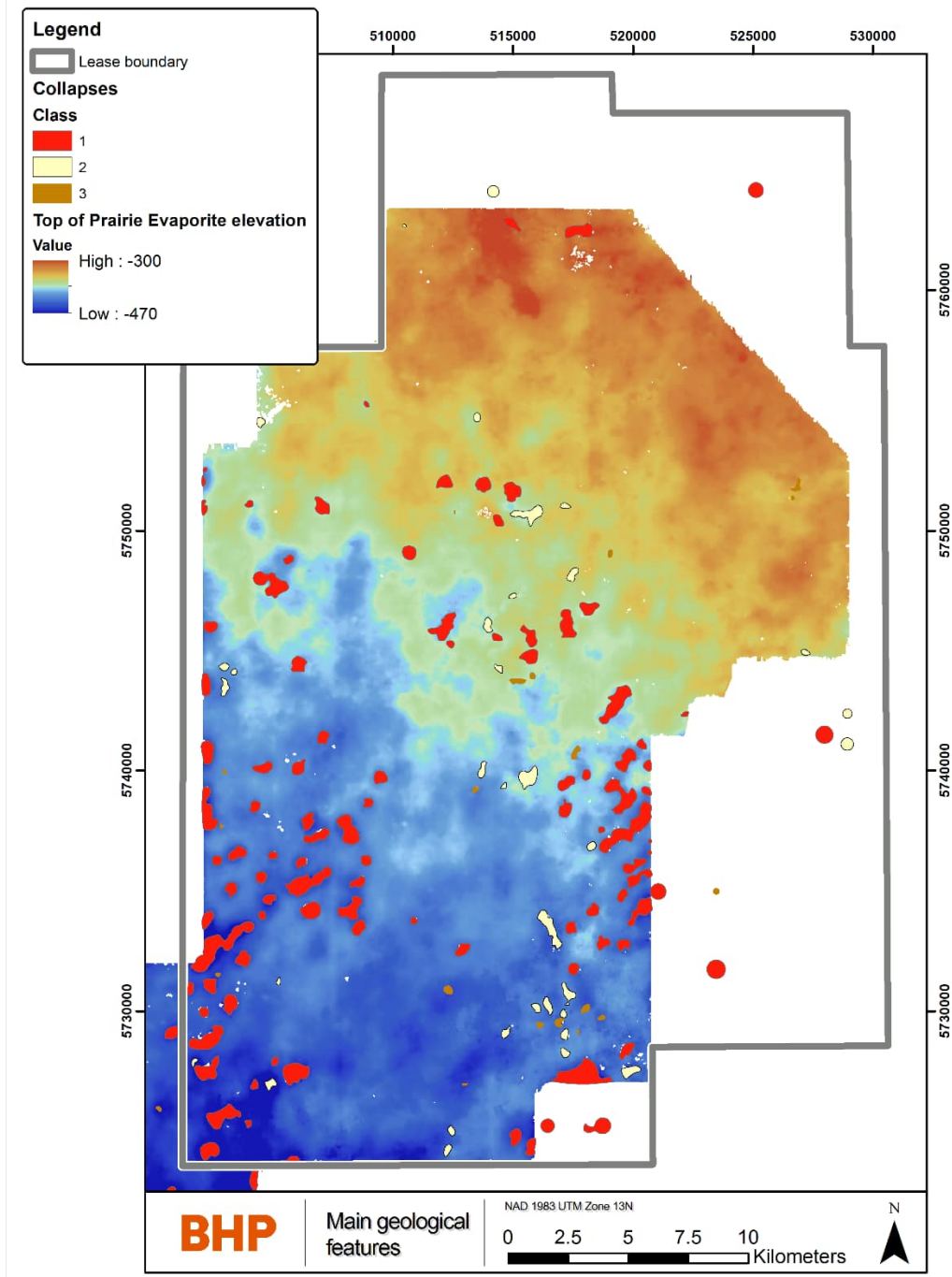

**Figure 7-2: Structural features and top of Prairie Evaporite elevation imaged by 3D seismic**

The seismic imaging is a mature technology originating in the oil and gas industry and has been successfully adopted by the potash mining industry. It is the opinion of the Qualified Person that the quality of the seismic surveys collected on the Jansen lease are excellent and the structural

For personal use only



and the quantitative interpretation work carried out at Jansen by BHP Canada geophysicists are at an industry standard practice level.

## 7.2 Exploration Drilling

Exploration drilling was carried out by BHP Canada:

- to obtain physical samples for geological mapping, geochemical analysis, rock mechanics and metallurgical testing,
- to acquire rock physical and hydrogeological property measurements using geophysical well logging,
- to acquire hydrogeological testing data from the brine disposal zone.

Drill hole locations were selected based on information obtained from the 2D and 3D seismic program to avoid structural features and regional potash anomalies. The distribution and spacing of the drill holes were chosen to complement the historical drilling locations to provide a uniform drill hole coverage across the central part of the lease area.

### 7.2.1 Drilling Type and Extent

All drill holes were drilled using petroleum industry oil rigs (Figure 7-3) with the rotary drilling method. The equipment requires an approximately 150 metres x 150 metres size drilling pad for the rig, equipment, and offices. The drilling operation was running 24/7 with contracted site geologists and BHP representatives overseeing the drilling and data collection operations. After completion of the drilling the drill site was reclaimed to its original state.

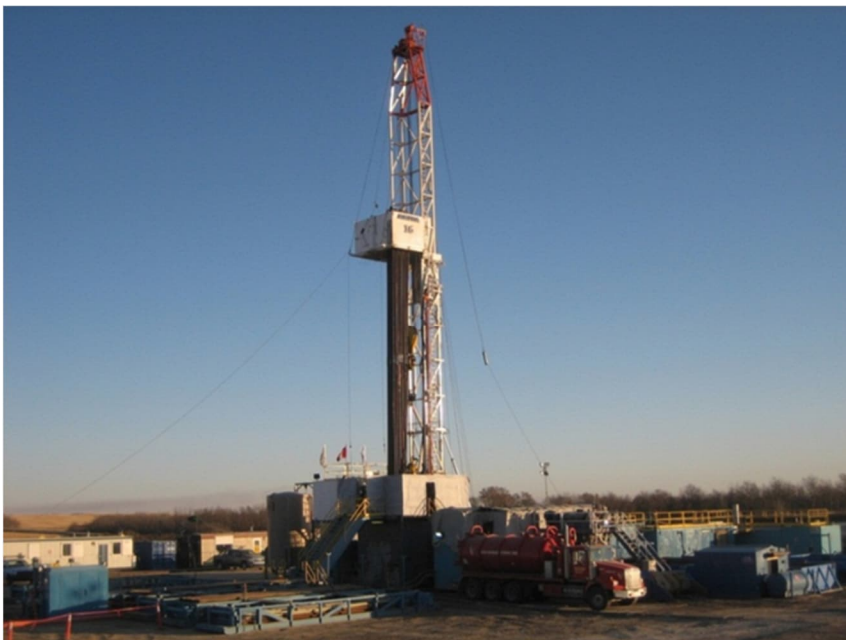

**Figure 7-3: Oil rig used in BHP Canada potash exploration drilling**

A summary of the drilling information is shown in Table 7-2:. Geophysical well logging was conducted in all holes from top to bottom.

**Table 7-2: Summary of BHP Canada drilling information**

Type of Drilling	Number of Drill Holes	Metres Drilled	Metres Analysed Using Geochemistry	Year
Potash exploration	24	24,500	596	2008-2009
Disposal zone testing and monitoring	2	3,100	-	2014
Shaft Pilot hole	2	2,076	89	2009
Shaft geotechnical	1	590	-	2014
Brine Injection well	1	1,500	-	2016
<b>Total</b>	<b>31</b>	<b>28,976</b>	<b>685</b>	-

### 7.2.2 Drilling, Sampling and Recovery Factors

#### Potash exploration drill holes

The stratigraphy of the region is well established based on the exploration completed to date. Most of the holes were drilled into the Prairie Evaporite Formation and were terminated once all the potash beds were intersected, below the Belle Plaine Member. A limited number of holes were drilled through the Prairie Evaporite into the Interlake Formation to provide calibration information for seismic analysis. One exploration hole was drilled to the Precambrian basement to obtain information about the entire sedimentary column including the target formation for brine disposal.

The drilling plan for each drill hole is divided into four sections:

- Section 1 – Conductor and surface section, installation of the conductor and drilling to set a required surface casing point (244.5 millimetres), as prescribed by the Saskatchewan Oil & Gas Conservation Regulations 1985.
- Section 2 – Intermediate section, drilling to the core point and setting a 177.8 millimetre intermediate casing string.
- Section 3 – Core section, drilling and coring using mineral oil-based mud utilizing 156 millimetre core equipment.
- Section 4 – Deep section, drilling either to the Interlake Formation or the Precambrian basement with 156 millimetre bit.

After drilling, the holes are plugged by cement and abandoned following the Saskatchewan Oil and Gas Conservation regulation procedures.

Details are shown in Figure 7-4, including abandonment procedures.

Exploration core recovery is 99.95 per cent which is considered excellent by the Qualified Person. Core depths are corrected to the geophysical logs depth to obtain a common depth reference for all data. The high core recovery enabled BHP Canada to take representative samples for the basis of the Mineral Resources estimate.

Drill hole locations are surveyed at planning and after spudding by a professional surveyor. During drilling the maximum deviation from the vertical was set to three degrees and was monitored continuously with downhole instruments. The drill holes' trajectory is surveyed after completion using the orientation logging tool that is deployed as part of the geophysical well logging program.

All holes are close to vertical with offset less than 10 metres between the surface coordinate and bottom hole coordinate. The shaft pilot holes were drilled with very small deviation tolerances.

All sampling, including geophysical logging, is conducted with QA/QC procedures in place with targets set and monitored, see Section 8 for details regarding these QA/QC procedures.

For personal use only

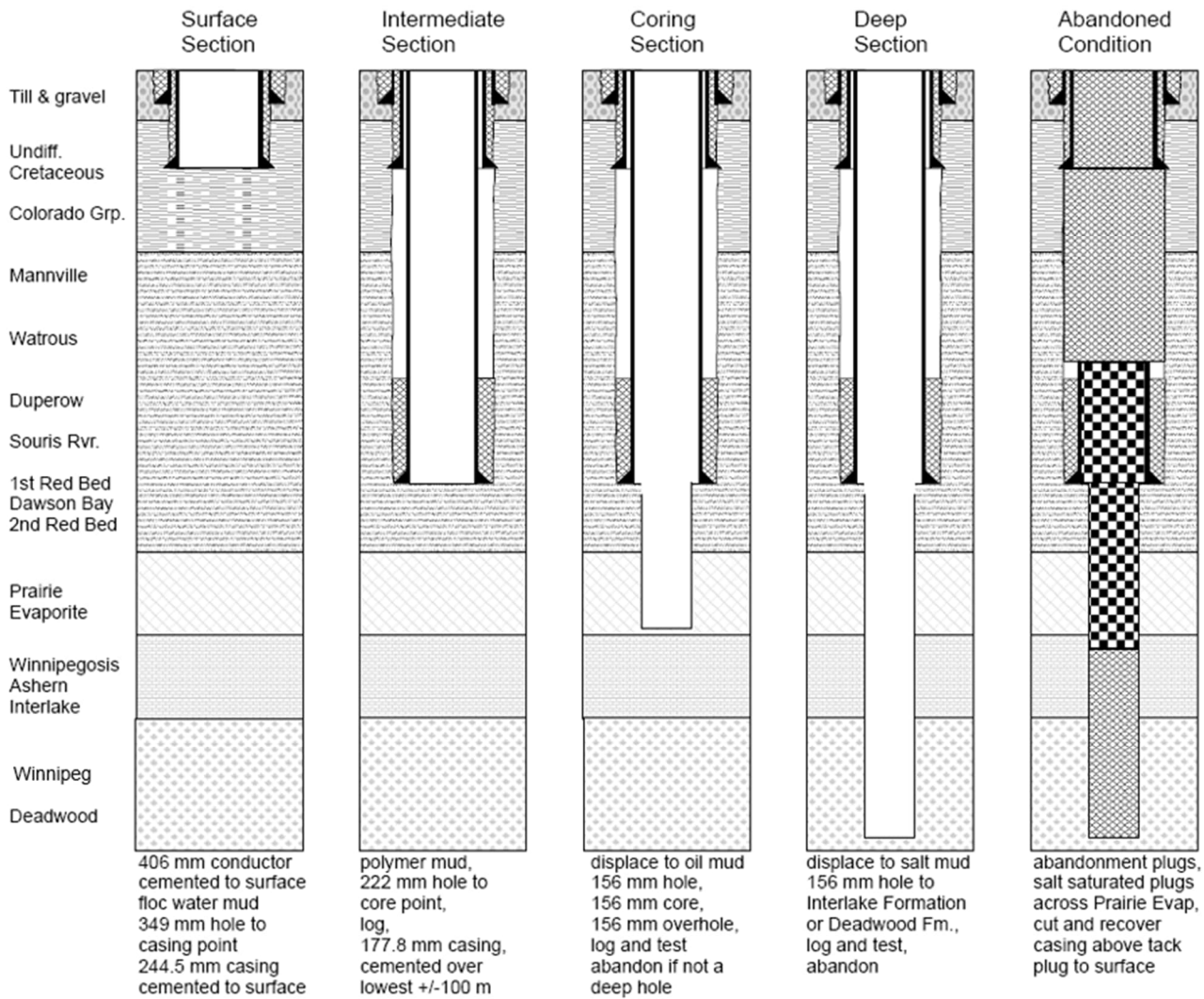

Figure 7-4: The four sections of the exploration drilling program and abandonment procedures.

### Brine disposal zone monitoring and testing holes and disposal hole

Two holes were drilled to obtain hydrogeological and rock mechanics information from the brine disposal reservoir zone. The preparation and execution were identical to the exploration holes except after setting surface casing the holes were drilled to the top of the Winnipeg Formation, then logged and cased. The lower section was drilled through the Winnipeg Sand and Deadwood formations into the Precambrian. Geophysical logging, hydrogeological formation testing and rock mechanics testing programs were carried out in this section (details in Section 7.3). Once the testing was completed the hole was cased and pressure and temperature monitoring equipment was installed at the Deadwood Formation (details in Section 7.3).

The brine disposal drill hole was drilled with similar set up, methodology, and data collection program to the monitoring holes, except the reservoir section was developed for the injection operation.

### **Shaft pilot holes and geotechnical hole**

Two pilot holes and a geotechnical hole were drilled to support the shaft sinking. The pilot holes, after the placement of the conductor and surface casing section, were continuously cored to the base of the Prairie Evaporite Formation. Geophysical well logging and hydrogeological testing were conducted before the pilot holes were plugged. The shaft geotechnical hole was drilled in a similar way to provide additional information for shaft sinking operations.

It is the opinion of the Qualified Person that the data (core, geophysical logs, hydrogeological testing data, etc.) obtained by drilling have a good quality and are reliable. They are suitable to be used for geological, hydrogeological, and other model development and related studies.

### **7.2.3 Drilling Results and Interpretation**

In agreement with the well-recognized regional geological and structural architecture of the Williston Basin, the drilling results show that the geological layers dip approximately 0.1 degrees to the southwest. The use of vertical holes is therefore deemed by the Qualified Person to be appropriate and ensures representative thicknesses are achieved across each stratigraphic unit. All anticipated stratigraphic units were present in the drill holes with normal thicknesses and lithologies, no unexpected geological conditions were encountered.

The exploration drilling further confirmed the presence of the Prairie Evaporite Formation and the UPL, LPL and Belle Plaine members in the entire Jansen lease. The depth of the LPL was found to be between approximately 850 metres in the north and approximately 1,050 metres in the south (Figure 7-5).

Holes drilled deep into the disposal reservoir confirmed the presence of the Winnipeg Sand and Deadwood formations with expected thickness, lithology, and hydrogeological properties.

For personal use only

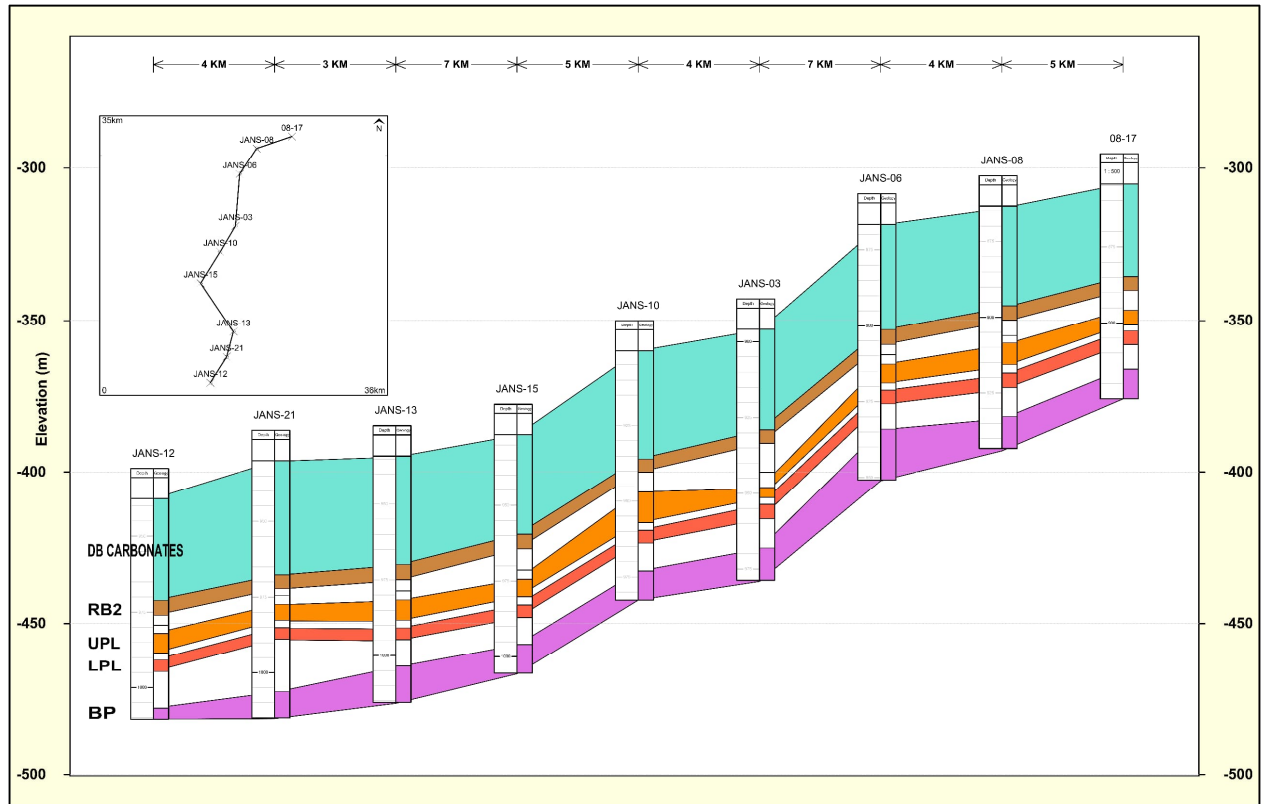

**Figure 7-5: North-South cross section showing main potash and geological units immediately above, (DB Carbonates – Dawson Bay Carbonates Member, RB2 – Second Red Beds Member, UPL – Upper Patience Lake sub-member, LPL – Lower Patience Lake sub-member, BP – Belle Plaine Member). The vertical axis is in elevation (m). Both historical and BHP Canada drill holes are included.**

### 7.3 Hydrogeology

The hydrogeology of the Jansen Project area consists of two groundwater systems:

- Near surface groundwater system that encompasses glacial till, silt, clay, sand and gravel
- Deep groundwater system that is characterized by underlying carbonates and sandstones units

The groundwater systems are separated by a low permeability shale formation.

#### 7.3.1 Near Surface Hydrogeology

##### Introduction

The near surface hydrostratigraphy is generally comprised of a complex sequence of sediments which include inter-bedded water bearing formations (i.e. aquifers for groundwater source) and low permeability sediments (i.e., aquitards as natural barriers to brine migration from the surface tailings facility). These stratified sediments, above the bedrock (Bearpaw Formation), are collectively known as glacial drift, and form a multi-stacked aquifer system across the Jansen Project area. The near surface hydrostratigraphy of the project area is summarized in Figure 7-6.

For personal use only

Stratigraphy			Lithology		Hydrogeology	
Group	Formation	Unit or Member				
Saskatoon	Surficial Stratified Deposits	Alluvium	Silt, Sand, Gravel	Clay, Silt, Sand	Surficial Aquifer/Aquitard	
			Silt, Sand, Gravel	Clay, Silt, Sand		
		Haultain	Silt, Sand, Gravel	Clay, Silt, Sand		
			Silt, Sand, Gravel	Clay, Silt, Sand		
	Battleford		Till		Aquitard	
			Gravel, Sand, Silt, Clay		Battleford Aquifer	
	Floral	Upper		Till		Aquitard
			Riddell (Middle)	Gravel, Sand		Upper Floral Aquifer
				Till		Aquitard
		Lower		Gravel, Sand, Silt, Clay		Lower Floral Aquifer
			Till		Aquitard	
Sutherland	Warman		Till		Aquitard	
			Gravel, Sand, Silt, Clay		Warman Aquifer	
	Dundurn	Upper		Till		Aquitard
				Gravel, Sand, Silt, Clay		Upper Dundurn Aquifer
				Till		Aquitard
		Lower		Gravel, Sand, Silt, Clay		Lower Dundurn Aquifer
				Till		Aquitard
	Mennon	Upper		Till		Aquitard
				Gravel, Sand, Silt, Clay		Mennon Aquifer
			Till		Aquitard	
Empress	Upper		Gravel, Sand, Silt, Clay (Proglacial)		Aquifer	
	Lower		Chert and Quartzite Sand on Gravel (Preglacial)			

**Figure 7-6: Schematic Near Surface Hydrostratigraphy in the Jansen Project Area**

### Data collection and QAQC

The near surface hydrogeology of the project area was evaluated by SNC Lavalin Inc. (previously MDH Engineered Solution Corp.) from 2008 to 2011. The near surface groundwater system was studied for the selection of suitable surface facilities (e.g., tailings management area and other infrastructure) to reduce the risk of shallow, aquifer contamination due to the long-term brine migration beneath the salt tailings facility, and for potential sourcing of water.

More than 200 boreholes were drilled for the hydrostratigraphic investigation, testing, and instrumentation (Figure 7-7). Over 100 monitoring wells (124 standpipe piezometers and 20 vibrating wire piezometers) were installed around the surface tailings management area perimeters as well as other strategic places to conduct borehole geophysical logging, hydraulic testing (slug test and pumping test), and collect groundwater samples for the acquisition of hydrogeological data and baseline groundwater chemistry. Numerous slug tests and one long duration (14 days) step drawdown pumping test were conducted. The data were analysed to estimate the hydraulic parameters of the aquifers and aquitards (Table 7-3). Tri-axial permeability tests were conducted to estimate the vertical hydraulic conductivity of the formations. A

groundwater monitoring network system was established within almost all near surface aquifers to better understand the groundwater flow system and potential hydraulic connection between aquifers.

**Table 7-3: Summary of Hydraulic Conductivity Values for the Near Surface Hydrostratigraphic Units**

Formation	Hydraulic Conductivity (m/s)		
	Minimum	Median	Maximum
Oxidized Saskatoon Group Sediments	2.2E-09	3.5E-08	2.1E-06
Upper Floral Till*	3.0E-11	7.5E-11	2.0E-10
Upper Floral Aquifer	2.6E-08	8.3E-05	2.0E-03
Lower Floral Till	5.0E-11	1.0E-10	1.6E-08
Lower Floral Aquifer	1.0E-07	8.1E-05	1.6E-03
Warman Till*	9.0E-11	9.5E-11	1.0E-10
Warman Aquifer	1.4E-05	1.5E-05	1.6E-05
Upper Dundurn Till*	3.0E-11	1.2E-10	2.0E-10
Upper Dundurn Aquifer	1.3E-06	8.8E-06	1.7E-05
Mennon Aquifer	4.3E-05	4.3E-04	5.7E-04
Empress Group Aquifer	8.4E-06	9.3E-05	2.4E-03

\* Includes only the tri-axial permeability test results

Quality Assurance and Quality Control (QA/QC) were utilized for all field work, analysis, and reporting. All work was completed using MDH trained engineers and professional hydrogeologists with provincial practicing licenses (Professional Engineer/ Professional Geoscientist). All drilling and installations were completed under the continuous supervision of trained engineers and geoscientists.

All groundwater samples were collected and analysed in accordance with the groundwater sampling standards and procedures and the ISO/IEC 17025:2005 accredited Laboratory Quality Management System (ALS Laboratory and Maxxam). Standard Chain of Custody protocols were followed during handling and transportation of all samples. Laboratory QA testing was completed by submitting blind and duplicate samples for comparative testing.

For personal use only

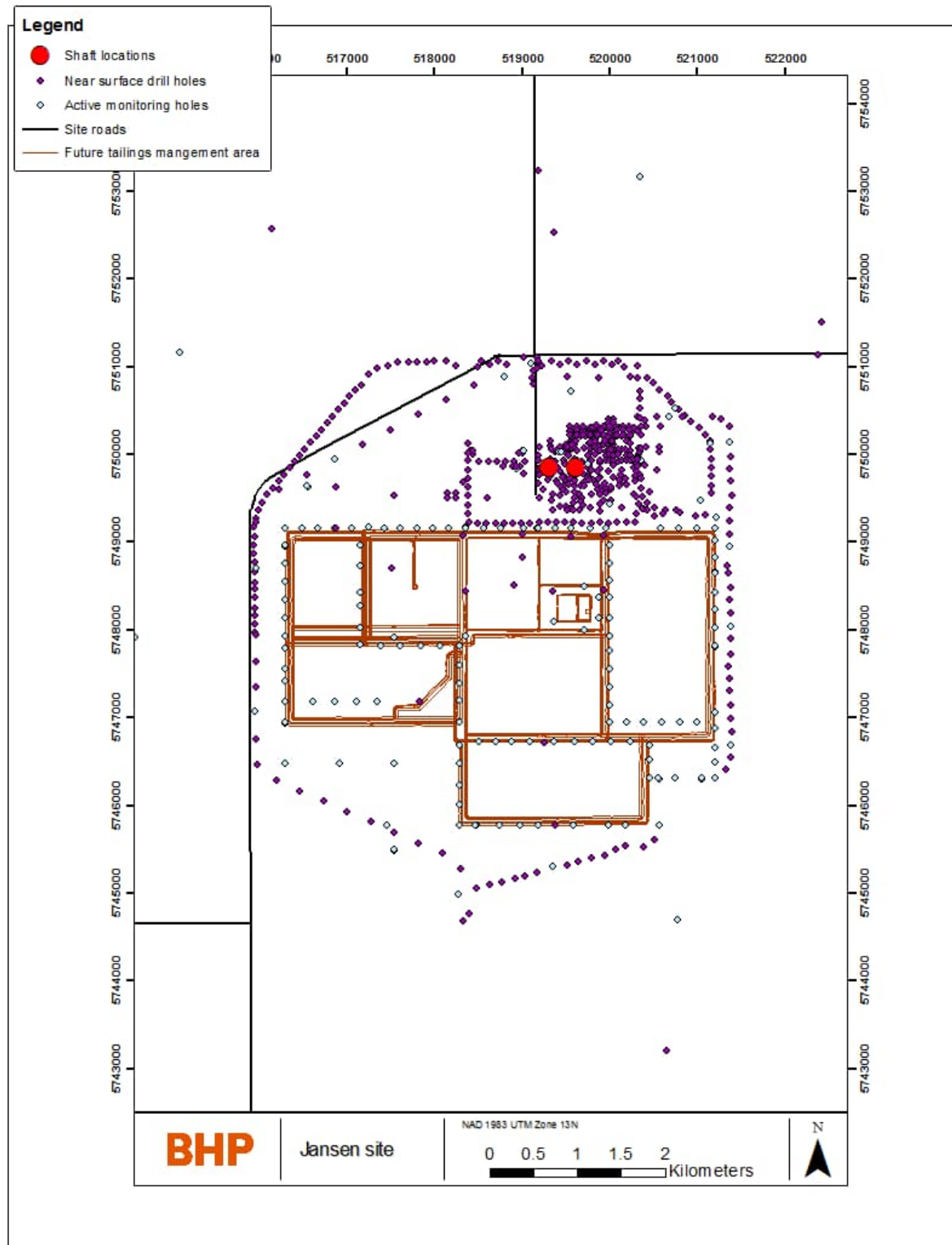

**Figure 7-7: Location Map of Boreholes and Monitoring Wells**

All data compiled within all reports (tables, spreadsheets, figures, borehole logs, cross-sections. Etc.) was reviewed to reduce the potential for error. To assure the quality of the final reports, all draft reports were reviewed by a senior MDH engineer.

**Results and Interpretation**



The near surface drilling, sampling and testing successfully delineated multiple aquifers and aquitards (Figure 7-8) beneath the TMA and determined their hydraulic properties (Table 7-4). In the Qualified Person's opinion, the level of detail in the hydrogeological investigations was sufficient to enable the development of a groundwater flow and contaminant transport model and formed the basis of groundwater protection from the brine migration. In the opinion of the Qualified Person, the silt and clay rich till of the Sutherland Group and the Saskatoon Group should act as the primary natural barriers to groundwater contamination at the tailings site based on the technical information available at the time of preparation of this report.

### 7.3.2 Deep Hydrogeology

#### Introduction

In descending order, the deep groundwater system consists of seven major water bearing formations. These formations are described below with their implications:

- Mannville Aquifer: Presents significant risk to shaft construction; however, it is a potential groundwater resource for mining and operation
- Duperow Aquifer: May pose risk of water inflow into a shaft or a mine (if it is hydraulically connected to the underlying water bearing formations)
- Souris River Aquifer: May pose potential risk of minor water inflow into a shaft or a mine (if it is hydraulically connected to the underlying water bearing formations)
- Dawson Bay Aquifer: In close proximity to the mining horizon and generally interpreted as dry (low permeability formation) in nature. May pose potential risk of water inflow into a mine if hydraulically connected to adjacent aquifers
- Winnipegosis Aquifer: May pose risk of water inflow into a mine from below when inadequate cap rock for the brine disposal horizon occurs or its integrity is impacted from the disposal operation
- Winnipeg Sand Aquifer: Subsidiary brine water bearing formation for underground brine disposal in the project area
- Deadwood Aquifer: Principal brine water bearing formations for underground brine disposal in the project area

The last two aquifers are usually named together as the brine disposal horizon. The deep hydrostratigraphy of the project area is summarized in Figure 7-8.

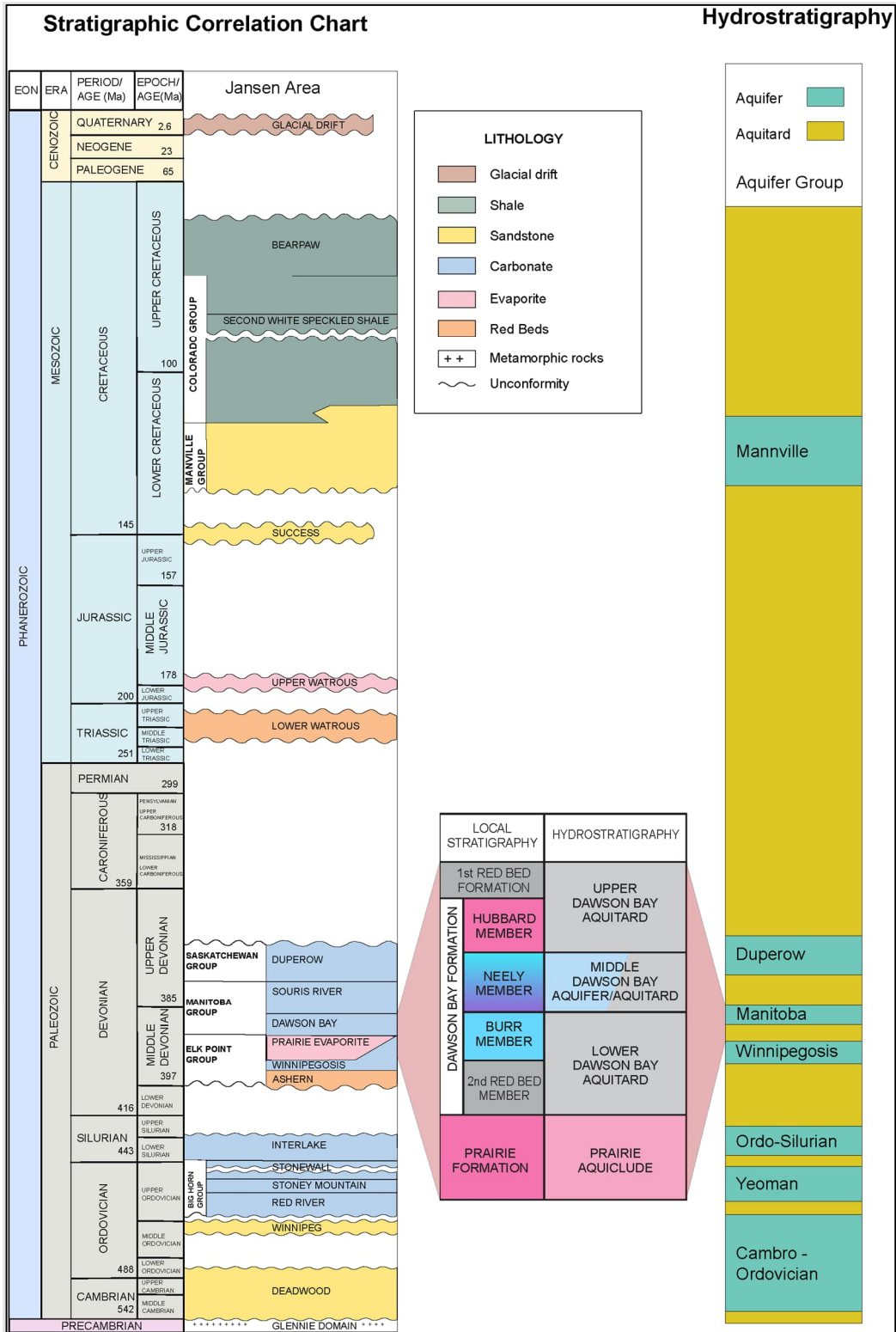

Note: The Interlake Formation within the Jansen Project area is found to be a low permeability formation and not considered an aquifer unit.

**Figure 7-8: Schematic Deep Hydrostratigraphy in the Jansen Project Area (modified based on Figure 6-4)**

**Data collection**

The deep hydrogeology of the project area was evaluated using oil field techniques by consultants (Schlumberger, Baker Hughes, Norwest, RESPEC, etc.). The deep groundwater system was investigated to assess potential risk of water inflow into a mine and to design a wellfield for the

For personal use only

underground disposal of potash waste brine. Eleven drill holes were tested to acquire hydraulic properties of the major aquifers of interest such as the Dawson Bay, Winnipeg Sand and Deadwood formations. Four out of eleven deep drill holes focused on the deep hydrostratigraphic investigation, testing, and instrumentation within the brine disposal horizon. Two deep monitoring wells are continuously collecting the formation pore pressure and temperature data of the brine disposal horizon to assess potential impact from the ongoing disposal operations in other mine sites in Saskatchewan.

Drill stem tests were performed in five exploration drill holes and two shaft pilot holes to assess the water deliverability potential of the Dawson Bay Formation. The tests indicated the low permeability nature of this formation. Following the drill stem tests, Formation Multi-tester (FMT) wireline tests were performed to measure the formation pore pressure and estimate the permeability values at several test points in 19 drill holes. Magnetic Resonance Logging was also conducted using Nuclear Magnetic Resonance (NMR) or Combinable Magnetic Resonance (CMR) tools to assess the water content in the formations in 25 drill holes. Five core plug samples from two exploration drill holes were additionally tested and analyzed in the independent laboratory “Core Laboratories, Inc.” in Houston to estimate the porosity and permeability of the Dawson Bay Formation. The laboratory results from four samples indicated the low permeability nature of the formation except for one sample that showed a relatively high permeability value (338 mD). The Dawson Bay Formation is considered one of the key hydrostratigraphic units for mine excavation, which overlies the Jansen mine level.

Modular Formation Dynamics Tester (MDT), Vertical Interference Test (VIT), and FMT tools were used in one deep drill hole to obtain hydraulic properties of the deep water bearing formations, with a special focus on the brine disposal horizon and caprock formations. Groundwater samples were also collected for baseline chemistry and isotope analysis. The MDT Live Fluid Analyzer (LFA) optical technique was utilized to ensure the sample quality by monitoring the fluid as it flows, its resistivity, and optical density. Mini-Frac and pressure falloff tests were performed to understand the formation pore pressure regime of the disposal horizon. A step rate injection test was conducted at the first potash waste disposal well to estimate the regulated wellhead injection pressure in accordance with the disposal and injection well regulatory requirements.

The data from all tests were analysed to characterize the major water bearing formations and compiled for the use of analytical and numerical brine disposal wellfield modelling. Table 7-4 provides a summary of the hydraulic parameters and values for the brine disposal horizon.

### **Hydrogeological Modelling**

To assess the risk associated with the brine disposal horizon and its sustainability, analytical models were developed by consultants (SNC Lavalin) from 2010 to 2019. In 2019, BHP Canada also developed a three-dimensional numerical brine disposal model using the industry standard groundwater modelling software FEFLOW to assess the formation pore pressure build-up and distribution during the disposal operation. The model was reviewed by an independent third party and updated based on the review comments and recommendations. An uncertainty analysis of the updated model was performed using a new probabilistic approach to quantify model uncertainties in 2022. BHP Canada additionally developed a three-dimensional reservoir geomechanical model to assess the risk and uncertainties associated with the brine disposal horizon and the overlying caprock. In the Qualified Person’s opinion, the Deadwood Aquifer and

the Winnipeg Sand Aquifer are available for the disposal of waste brine and no material adverse impact in the brine disposal operation is expected for the Jansen Stage 1 at the time of preparation of this report. The risk and uncertainty associated with the long-term sustainable capacity of the brine disposal horizon will be assessed as waste disposal operation begins and advances.

**Table 7-4: Summary of Hydraulic Parameters and Values Measured in Field for the Brine Disposal Horizon**

Formation Name	Permeability (mD)		Porosity (%)	Comments
	Horizontal	Vertical		
Winnipeg Sand	0.1 – 3000	Not Available	6 – 28	Permeability values based on borehole logs. A large-scale test (such as injection test) was not conducted to determine the horizontal and vertical permeability values due to the small thickness (~ 18 m) and minimum usable disposal reservoir interval (~ 8-9 m) of this formation.
Deadwood	288 – 403	29 – 43	3 – 28	Permeability values based on MDT/MDT-VIT/Injection Test

**Results and Interpretation**

The characterization of the major deep water bearing formations in the Jansen Project area is in agreement with the regional hydrogeological understanding of the Western Canada Sedimentary Basin and the Williston Basin.

Based on the hydrogeological and geophysical information available at the time of preparation of this report, the Dawson Bay Formation is characterized as a low permeability unit in the Jansen area and has relatively low water inflow deliverability potential. In the Qualified Person’s opinion, the Dawson Bay Formation is well understood.

The characterization of the brine disposal horizon is also in agreement with the local and regional scale hydrogeological understanding. In the opinion of the Qualified Person, the horizon is available for the disposal of potash waste brine and no potential adverse impact on its disposal capacity is expected.

**7.4 Geotechnical Data, Testing, and Analysis**

Geotechnical data was acquired through two testing programs. The first testing program was completed by independent consultant “RESPEC”, through samples acquired from three exploration drill holes. Testing consisted of Brazilian indirect tensile strength (BRZ), constant strain rate (CSR), constant mean stress (CMC) and tri-axial compression creep (TCC). The results of these tests were used as input values for modelling.

The second testing program was completed at the University of Saskatchewan “Rock Mechanics Lab”, with samples acquired from six exploration drill holes. Tests conducted included, Unconfined Compressive Strength (UCS) and acoustic velocity, with all tests occurring in salt. Due to the age and unknown handling of the core, these tests were not included in the modelling work.

For personal use only

Tests for the Dawson Bay Formation and Second Red Beds were acquired from two exploration holes. Five CSR tests were completed for the Dawson Bay Formation and four were completed for the Second Red Beds. The intent of the CSR test is to determine the elastic properties of the sample. Also completed for the Second Red Beds were seven BRZ tests. The tensile strength tests provide inputs into evaluating the tensile strength of the roof and floor of an excavation.

Mechanical testing in the Prairie Evaporite consisted of BRZ, CSR, CMC and TCC. Samples were acquired from all three exploration drill holes. Tests completed, included, thirty-six BRZ tests, twenty-one CSR tests, forty-one CMC tests and twenty five TCC tests.

CMC tests were run at a temperature setting of 20°C. The intent of running the CMC tests was to determine the location-specific dilation characteristics and to use that location dilation data to estimate the parameter values in a dilation equation. The CMC test data showed a fairly consistent trend for all tests where the level of stress difference required to initiate dilation usually increased with the increase in mean stress. The CMC data was used to compare against the linear tri-axial compression equation. The result were non-linear values that plotted above the linear criterion at a low mean stress and below the linear criterion at high mean stress.

For the TCC tests, setup parameters included, temperature set to 27°C, confining pressure at 20 Mpa with applied stress differences of 6.9, 10, 15 and 20 Mpa. The purpose of the TCC test is to determine the axial strain over time within the sample. The results showed that strain rates started high immediately after the axial stress difference was applied, slowing to a near constant rate of strain with time. The predicted steady-state strain rates generally correlated well with the calculated steady-state strain rates.

From the TCC tests, the estimated stress exponent for roof and floor salts was  $n = 3.6$ . For potash ore the estimated stress exponent was  $n = 5$ . The laboratory creep data parameters utilized for the Jansen mine design are within the expected range for the potash basin. The validation process for the geotechnical parameters has been initiated with installation of geotechnical instrumentation within the shaft barrel and shaft stations. The shaft pillar ground monitoring program has been planned to further quantify the actual creep rates for each cutting horizon.

The test results are listed in Table 7-5 for the CSR tests and Table 7-6 for the BRZ tests.

**Table 7-5: CSR test results**

Sample Location	Quantity	Average Young's Modulus (Gpa)	Average Poisson's ratio
Dawson Bay	5	47.02 +/- 6.35	0.25 +/- 0.08
Second Red Beds	4	17.23 +/- 3.22	0.12 +/- 0.01
Potash	9	19.03	0.16
Salt	12	25.79	0.14

**Table 7-6: BRZ test results**

Sample Location	Quantity	Average Tensile Strength (Mpa)
Second Red Beds	7	2.93 +/- 1.36
Salt	21	1.62 +/- 0.33
Potash	15	2.13 +/- 0.70

In the Qualified Person's opinion, the tests completed are those necessary to develop models for the assessment of short and long term stability conditions in Prairie Evaporite and into the Second Red Beds and Dawson Bay. Samples within the Prairie Evaporite covered the UPL, LPL and Belle

Plaine potash units and salt layers in between, which is necessary to understand what may cause ground instability.

The geotechnical samples represent mining areas at the northwest, central and southern end of the lease. In the Qualified Person's opinion the sampling seemed sparse, however, given the consistent results acquired from other properties within the basin when compared to the Jansen samples, it provides confidence that the rock will behave similarly.

For personal use only

## 8 Sample Preparation, Analyses, and Security

### 8.1 Sample Preparation Methods and Quality Control Measures

#### 8.1.1 Methods

Mineralized zones in each of the Jansen drill holes completed by BHP Canada were subject to coring and geochemical analysis. The salt beam between the UPL and LPL was included in the geochemical analysis. Once the core was recovered from each new drill hole, logged, photographed on site, and wrapped in waterproof plastic to protect the carnallite sections, the cores were securely transferred from the drill site to BHP Canada's core lab in Saskatoon. The core box summary sheet, core transport waybill, and hard copy geophysical well logs accompanied the core.

The climate-controlled core lab facility rented from the Saskatchewan Research Council – Saskatoon (SRC) was equipped with roller tables, core racks, work tables, rock saw and crusher, lift trolleys, dust collector, and air compressor. SRC provided saw and crusher operators, as required. Air quality was monitored periodically or at the request of core lab geologists. Temperature and humidity were monitored and recorded twice daily, because carnallite is deliquescent and therefore sensitive to atmospheric moisture.

Geological consultant company Norwest Corp. compiled geological reports for each BHP Canada exploration hole, field records originated from wellsite geologists, drilling supervisors and coring contractors. Norwest Corp. geologists, who were trained in potash logging, operated the core lab. After the core was delivered, it was unloaded onto roller tables. Geologists ensured all core runs were properly oriented in the boxes and depths were corrected to match the geophysical well logs. The core was then subject to descriptive logging completed electronically on spreadsheets and emailed to BHP Canada geologists. (i.e., lithology, texture, crystal sizes, contacts, colour, sedimentary structures, constituents, fossils, and geotechnical features), and high-resolution colour photography. Sample interval selection completed with collaboration with BHP Canada geologists. A flow chart of the core logging process is shown in Figure 8-1.

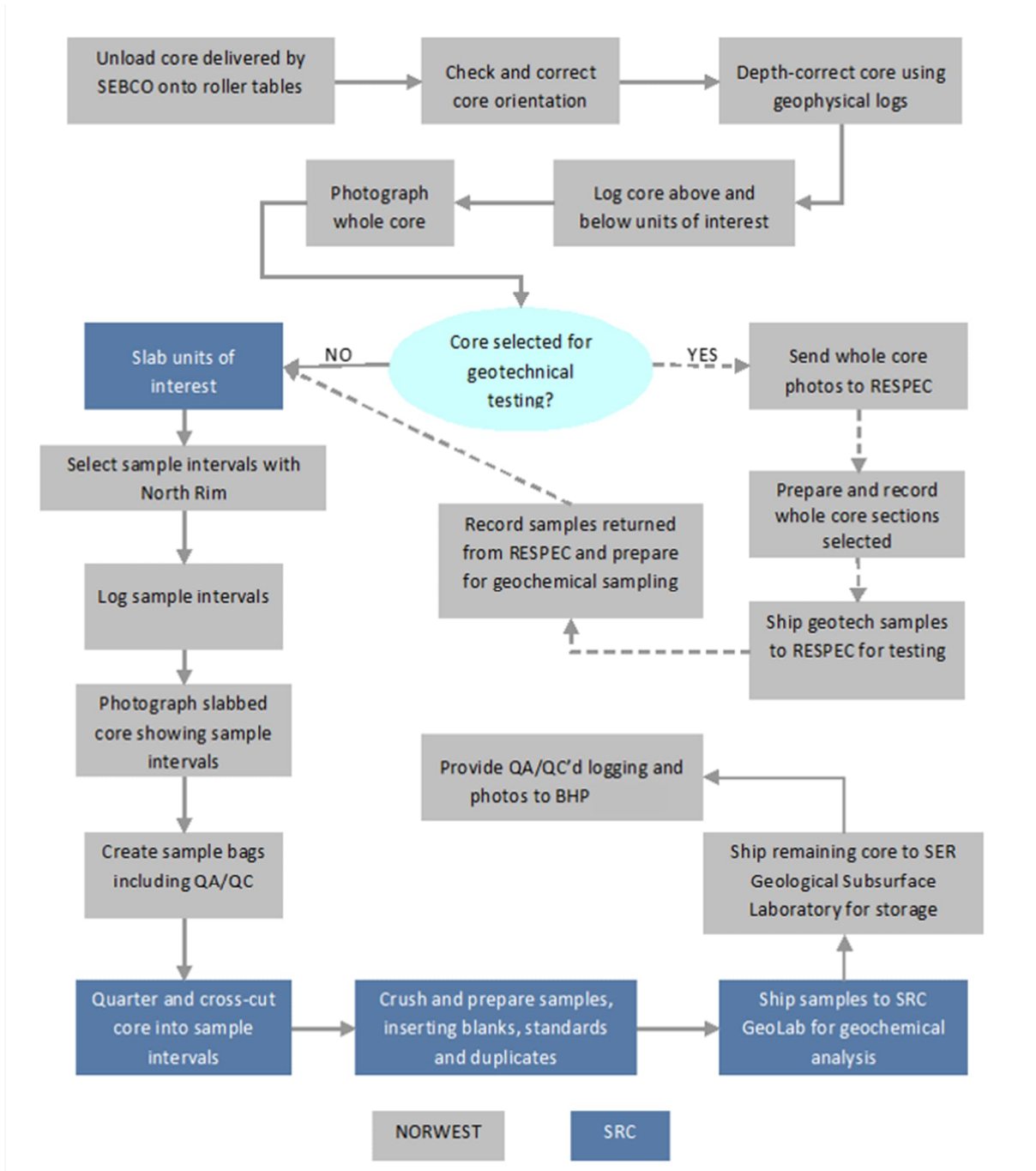

**Figure 8-1: Core logging and sampling workflow**

If the core was selected for geotechnical testing, the photographs were reviewed for quality assurance and provided to the geotechnical consultants (RESPEC) from a secure file transfer site.

The units of interest (i.e., UPL, LPL, and Belle Plaine Member) were slabbed by SRC crews at the core laboratory under the direction of Norwest Corp. geologists. The slabbed core was divided into sample intervals as determined by the geologists in conjunction with senior potash geology consultants (North Rim).

Sample intervals were based on lithology and ranged in size from 2 centimetre to a maximum of 25 centimetre. Sampling began a minimum of 0.5 metres above the top of the UPL through to a minimum of 0.5 metres below the base of the LPL and then from a minimum of 0.5 metres above

For personal use only



the top of Belle Plaine Member to a minimum of 0.5 metres below the base of the Belle Plaine Member. Slabbed intervals were photographed.

After the sample intervals and measurements were marked on the core and recorded in the logging Excel worksheet, one of the slabbed halves was quartered and one of the quarters was subsequently split into the noted intervals for geochemical analysis. The other quarter was packaged into plastic sleeves and reserved for shipment to the Government of Saskatchewan Subsurface Geological Laboratory in Regina, together with the entire core above and below the units of interest, as required by the regulations. The remaining slabbed half of the LPL was packaged for shipment to SGS Lakefield for metallurgical testing.

Norwest Corp. core lab geologists and senior potash consultant (North Rim) regularly transferred the logging, sample interval sheets, whole core photographs, and slabbed core photographs to BHP Canada for storage on the file server at the Saskatoon office. Each step followed proper procedures and documentation as well as cross checking between consultants and BHP Canada personal.

Historical drill hole reports, logging, collar location surveys and core assay data were acquired from the Saskatchewan Ministry of Energy and Resources database. All historical and BHP Canada drill hole core are available at the Saskatchewan Subsurface Geological Laboratory for storage and public access.

### 8.1.2 Sample Security

Chain of custody protocols were implemented, covering the sampling process from core collection at the drilling site, through sampling at the core laboratory, and to sample delivery to the analytical laboratory. These included:

- Boxing, labelling, and sealing of the core at the drill site before transferring to the laboratory preparation facility
- Photographing the core at the drill site then before and after sample selection
- Despatch requests were sent with the samples and emailed directly to the laboratory
- Laboratory confirmation of sample receipt
- Emailing the analysis results directly to BHP Canada
- Returning leftover samples to BHP Canada for storage

Additionally, in the core laboratory, before sampling, the core was verified against the in situ collected geophysical logs and any discrepancies were addressed.

No sample security documentation is available for the historical holes.

## 8.2 Sample Preparation, Assaying and Analytical Procedures

During BHP Canada's drilling campaign (2008, 2009) 3,956 samples were collected. The length of the samples was variable (average sample length 15 centimetres) to capture key geological features. Sampling protocols and procedures are aligned with industry standard practices. The sample preparation protocols (crushing and pulverising sizing requirements, etc.) at laboratories meet standards defined in contracts in line with ISO standards, with QA/QC targets established.

BHP Canada submitted samples for geochemical analysis to SRC Analytical Laboratories – Saskatoon, which is independent of BHP. SRC analysed all the geochemical samples using the Inductively Coupled Plasma – Optical Emission Spectroscopy (ICP-OES) method. Metallurgical testing of all metallurgical samples was conducted in SGS Lakefield Ltd. Laboratory. SGS is a commercial facility and is independent of BHP. Both laboratories are ISO/IEC 17025 certified. The samples were analyzed for the following: Soluble ICP CaO, K<sub>2</sub>O, Na<sub>2</sub>O and MgO wt%, wt% insoluble, wt% moisture, as part of the potash exploration package. The geochemistry analysis method termed “POT” by SRC.

Historical drilling (1952-1965) contributed 1,170 samples with variable sampling interval thicknesses to the exploration data set. Historical drill hole samples collected by Kerr-McGee Corporation were processed in their internal laboratory (Kerr-McGee Research Laboratory) by titration method.

Once the quartered core was cut into selected sample intervals, the samples were jaw crushed by SRC crews on site at the core lab. AA revision was made to the POT method after sampling the first core when it was discovered that crushing was too fine to enable the metallurgical testing of reject material. Initially, samples were crushed to 60 per cent at -2 millimetres. The standard operating procedure for the POT method was subsequently revised, and all subsequent samples were crushed to -6 millimetres. A comparison of analytical results from samples subjected to both crushing resolutions has verified that the degree of crushing does not materially affect the analyses. This parameter is continually monitored as part of the QA/QC program by comparing the analytical results of inserted site duplicate samples.

After the sample was crushed, a 100 gram to 200 gram sub-sample was split out using a riffler splitter, and transferred to a sealed plastic vial for transport to the SRC Geoanalytical lab. The reject crushed material was stored by SRC in sealed pails at a separate storage location.

At the SRC facility, the samples were pulverized to -106 microns using a puck and ring mill, and were then submitted for analysis. Pulps were analyzed for solubles, insolubles, and moisture content. Solubles were analyzed by Inductively Coupled Plasma – Optical Emission Spectroscopy (ICP-OES).

### 8.3 Quality Control /Quality Assurance Procedures

BHP Canada defined a Quality Control/Quality Assurance (QA/QC) program to ensure an appropriate level of confidence in the accuracy, precision and control of contamination of the geochemical data derived from core sampling and analysis. Precision is the capability of consistently repeating the results of a certain measurement in a similar condition, accuracy is the proximity to a certain measurement to a real or accepted value and the contamination is the unintentional transfer of material from one sample to another during the process. This program includes standards, blanks, as well as laboratory and site duplicates. All the BHP Canada control samples were inserted “blind” within the batches delivered to the SRC laboratory thereby not being disclosed to the laboratory as is standard industry practice.

#### Standards

The standard samples employed were selected based on their mineralogical characteristics to ensure a wider spread of QA/QC check validity for the relevant mineralogical compositions. BHP Canada inserted 2.5 per cent (1 in 40) standards to check primarily for analytical accuracy and

secondarily for analytical precision. SRC results demonstrated good performance for  $K_2O$  analysis, all lie within +/-5 per cent error range.  $MgO$  results were within +/-10 per cent error range except for <1 per cent of the samples.  $Na_2O$  samples performed well in the 32.49 % $Na_2O$  standard. Results were all inside the +/-2.5 per cent error range. However the standard containing only 1.61 % $Na_2O$ , 7 per cent of the samples were presenting more than a 10 per cent error. As is to be expected at low to very low levels for these compounds some samples present values that are out of acceptance limits. Similarly, analyses for insolubles and moisture determination, which are generally at low to very low levels, also present poorer accuracy and precision as a consequence of working close to lower detection limits of the methodologies used to make these determinations. In the case of analyses for moisture analytical quality may also be due to the exposure of the cores to varying environmental conditions. (i.e. humidity and temperature).

### **Analytical Blanks**

Analytical blanks (coarse or fine material i.e. silica sand with negligible levels of the main elements of interest) were inserted to check for cross contamination during the pulverization and analytical stages and as a check on analytical precision and accuracy. A total of 96 blanks inserted containing  $K_2O$  at 0.09 per cent,  $MgO$  at 0.0076 per cent,  $Na_2O$  at 0.11 per cent and the moisture at 0.08 per cent being constituted entirely of insoluble residue at 98.98 per cent. Blanks were also employed to verify the laboratories real lower detection limits. SRC's performance with the analytical blanks was very good. A few samples (<2 per cent) indicated some very minor contamination from earlier samples in either preparation or analyses, however the level of contamination never exceeded (0.38 % $K_2O$ ) and is considered close to established analytical precision and accuracy.

### **Site duplicates**

Site duplicates are included to test representativity and variability of taking two separate crushed drill core samples from the sample length of core. These duplicate samples are generated after crushing and being split off using a riffle splitter for the analytical work. 97 per cent site duplicates fell within the +/-10 per cent tolerance level for the entire suite for  $K_2O$ ,  $MgO$  and  $Na_2O$  analyses.

### **Laboratory Duplicates**

BHP Canada inserted laboratory pulp duplicates to test laboratory precision (reproducibility) of the various analyses performed. Data for the insolubles, mostly fell within the +/- 10 per cent error bars, with a few pairs falling slightly outside this when the insoluble content got below 5 per cent, more so below 2 per cent.

### **SRC Geoanalytical Laboratories Internal QA/QC**

SRC Geoanalytical Laboratories also undertake internal quality control measures and data verification procedures. These included the preparation and insertion of standards one in every 20 samples and laboratory duplicates (repeats), one in every 40 samples to each analytical batch. Instrumentations were calibrated according to ISO/IEC 17025. These data were reported to BHP Canada.

SRC performed well with the standards as  $K_2O$ ,  $MgO$  and  $Na_2O$  all were within 5 per cent tolerance range. Laboratory duplicate pairs all fell within +/-10 per cent with most pairs being in +/-5 per cent error ranges for  $K_2O$ ,  $MgO$  and  $Na_2O$ .

## Data Verification

The assay data collected by BHP Canada were checked against geophysical logging data for every drill hole. This process provides additional verification of the collected assay sample data.

For the validation of SRC's analyses, a subset of 193 samples was analyzed by another geoanalytical laboratory (SGS Lakefield), and compared to the SRC results. As previously mentioned, SRC's analytical method is ICP-OES. However, the analytical method used by SGS is titration, which analyzes for K and not  $K_2O$ , and the results must be converted to  $K_2O$  ( $\%K \times 1.2 = \%K_2O$ ). Since  $K_2O$  is the compound of principal interest, the  $\%K_2O$  determinations formed the basis of the comparison.

A slight bias was noted in the SRC data, reported as slightly higher  $K_2O$  values on average than SGS. Because both labs are providing very similar values for the standards, duplicate pairs and blanks, it is difficult to determine which lab is reporting the "correct" values for  $\%K_2O$ . However, this bias is minor therefore the Qualified Person's opinion is that the analytical variation for the different  $\%K_2O$  determinations from the two labs is within acceptable limits of analytical variation and tolerance.

## Historical Drill hole data verification

Historical drill holes represent approximately 50 per cent of the total drill holes, totalling 1,170 samples. The analytical data associated with these historical drill holes, which had been collected in the period of 1956-1965, does not possess any QA/QC information from that period, as was typical at that time. BHP Canada has validated the quality of this analytical information through a review of the geology of the drill hole cores (relogging) and statistical comparisons against the BHP Canada collected data (3,956 samples). To ensure confidence in this historical data, BHP Canada drilled one twin hole 17 metres from a historical hole. Overall  $K_2O$  grade for the LPL zone in both drill holes were in agreement. The average grade of the  $K_2O$  interval in the historical hole was 26.8 per cent compared to the BHP Canada twin hole was 26.5 per cent.

The statistical analysis showed that the quality of the  $K_2O$  geochemical analysis done on the historical data is statistically not different from the analysis done on the BHP Canada collected samples.

The statistical analysis done on the historical insoluble analysis indicated that these measurements contain a systematic bias compared to the BHP Canada data, therefore insoluble data from the historical drill holes was not used in the resource estimation.

## Discussion and Qualified Person's Opinion

The deposit shows limited grade variability. This is demonstrated by the relatively simple mineral composition characteristics, lack of structural complexity, and the continuous nature of the mineralization. The  $K_2O$  grade average is 25.6 per cent for the historic drill holes and 25.9 per cent for the BHP Canada drill holes.

Historical drill hole data was manually entered from the copies sourced from the Saskatchewan Ministry of Energy and Resources database. An internal review of the data entered against the source files was completed and entry errors corrected.

BHP Canada exploration data is managed internally using processes and systems that follow the BHP Canada data management procedures and protocols. The BHP Canada potash exploration

For personal use only

database has a security model, which restricts user access to those with supervisor approval and the system tested and reviewed yearly. All primary data sources for the drill holes are stored on a secure server that is backed up routinely.

BHP Canada's modelling work procedures require statistical checks to ensure the data used for interpretation honours the exploration database source data.

In the opinion of the Qualified Person the sampling procedures and analytical data control processes undertaken by SRC ensure data of sufficient accuracy, precision and control of contamination for the main chemical elements of interest and that the data is suitable to support resource estimation. Additionally in the opinion of the Qualified Person the historical  $K_2O$  values were found to be suitable to be used in resource estimation.

#### 8.4 Opinion on Adequacy

The Qualified Person's opinion is that drill core logging, core sample selection, preparation, assay, and security measures taken to ensure the validity and integrity of the samples and all QA/QC measures during these stages in both historical drilling and BHP Canada exploration drilling are adequate and acceptable. Data collection and quality is to industry best practices to support the current resource model and is adequate in terms of accuracy and precision for the main elements of interest,  $K_2O$ ,  $MgO$ , and  $Na_2O$  at the level of interest.

#### 8.5 Non-Conventional Industry Practice

There were no procedures followed that are not part of conventional potash industry practices.

## 9 Data Verification

### 9.1 Data Verification Procedures

#### 9.1.1 External Reviews

As confirmation of the mineral reserve and resource process, third-party consultants are occasionally hired to perform verification studies. The Jansen Mineral Resources were most recently reviewed by an independent third party in May 2020. That review included database checks and concluded that the database supporting the geological information of the resource estimate is complete and complies with mining industry standards. The review did not identify any major issues with the geological model or resource estimate. All issues identified have been addressed and no update to the resource estimate has been made. No changes in the geological modelling or resource estimate processes have been implemented since the 2020 review.

Assay database verification was undertaken by a contracted database company hosting the acQuire database. Any new data input into the database underwent strict verification to ensure the data was accurate. Any issues with data caused the database to reject the dataset and an error report was generated to reflect any issues with import. When this occurred, the data was corrected by a BHP Canada representative in charge of the database maintenance and re-imported. Administrative access to the database was restricted to a single user.

After the transfer of the assay data from the acQuire database to the OpenWorks database, a database verification process was carried out to ensure that the data was transferred properly. During the currently ongoing OpenWorks to EPOS data transfer, similar QA/QC processes were put in place to check the data integrity and potential errors.

In 2006 and 2007 extensive review of historical holes were conducted by NorthRim Exploration.

#### 9.1.2 Internal Reviews

An independent internal review of the sampling and data collection was undertaken after the completion of the BHP Canada drilling program at Jansen in 2012, and on the geophysical data collection and interpretation in 2015. QP's had been involved in reviews. No material risks to the project were identified and all key recommendations have been completed.

A twin hole was drilled 17 metres away from one historical drill hole and the results were compared. The grade difference was within an acceptable range.

A self-audit was performed by the QP for historical drill hole geochemical data in the database back to the original data to verify the quality of the original manual database input in 2019. Overall, the historical drill hole database geochemical entry error was negligible. In summary, data verification for the Jansen has been performed by BHP Canada staff, and external consultants contracted by BHP Canada.

### 9.2 Limitations

Excessive drill holes are not desirable in potash mining as they may present a risk for an inflow by connecting mine openings to the above or below aquifers. The spacing between drill holes is approximately 3.6 kilometres. However, the drill hole spacing is supported by both geological

considerations and aligned with Saskatchewan Potash industry practices. The drilling program was supported with 3D seismic surveys for detailed resource characterization.

### 9.3 Opinion on Data Adequacy

The historical data collected (1956-1965) has no QA/QC data available. BHP Canada has verified the quality of this information through a review of the geology of the cores (relogging) and statistical comparisons against the BHP Canada collected data (3,956 samples). It is the Qualified Person's opinion that the historical K<sub>2</sub>O values are suitable to be used in resource estimation. The statistical analysis done on the historical insoluble analysis indicated that these measurements contain a systematic bias compared to the BHP Canada data, therefore insoluble data from the historical drill holes was not used in the resource estimation.

The Qualified Person's opinion is that Jansen drill hole data and other supporting geological data align with accepted industry practices and are adequate for use in mineral reserve and mineral resource estimation.

For personal use only

## 10 Mineral Processing and Metallurgical Testing

Metallurgical testing for the Jansen project occurred in several phases. The initial test work was conducted at SGS Lakefield (SGS) to investigate the amenability of the Jansen ore to recovery by froth flotation and to get an estimate of the recovery that could be expected. SGS is a commercial facility and is independent of BHP. The SGS test work using core samples representing the LPL mining horizon of the Jansen orebody, was completed between December 2008 and June 2009. Additional metallurgical test work was performed initially at Eriez Flotation Division, USA in 2015 to verify flotation equipment technology selection and later at the Saskatchewan Research Council (SRC) in Saskatoon between August 2016 and August 2017 to verify process equipment selection and process design. The SRC laboratory is independent of the BHP. The ore used for the 2015-2017 test programs was from remaining Jansen drill core and representative sourced ore from an operating Saskatchewan potash mine that was determined in the QP's opinion to be representative of the Jansen run-of-mine ore. Additional supporting test work was completed in 2018 that duplicated the 2015-2017 test programs with ore from the shaft sinking program which was from the Jansen LPL sub-member. The ore from the 2018 testing program was determined to be representative of the Jansen run-of-mine ore in components and particle size.

### 10.1 Testing and Procedures

Initial metallurgical test work was performed from 2009 to 2018 to confirm assumptions and to generate process design data where none previously existed. The process design parameters requiring quantification during the test work programs included:

- Liberation size determination to indicate what comminution (particle size distribution) is required
- Influence of process water on flotation performance
- Effectiveness of insoluble mineral liberation processes as water insolubles must be mostly removed before flotation
- Reagent type, dosage, and method of application
- Degree of variability in potash recovery results across the ore-body under standard test conditions
- Recovery and product grade achievable during locked cycle tests
- Flotation product size distribution
- Settling rate of liberated insoluble minerals for equipment sizing
- Flotation recovery and throughput expectations with chosen flotation equipment for mass balance and equipment sizing
- Product leaching kinetics for equipment sizing and process design
- Variability testing to better understand coarse and fine flotation performance with varying feed characteristics, feed rates, equipment operating parameters, and reagent rates. This



was completed to enhance understanding for process design and for programming of dynamic simulation.

To determine the assays of key elements in the test work (e.g., potassium [K], sodium [Na], calcium [Ca], and magnesium [Mg]), accuracy of various analytical methods were compared, including:

- Atomic emission spectroscopy (AES)
- Atomic absorption spectroscopy (AAS)
- Inductively coupled plasma spectroscopy (ICP)
- Whole rock analysis (WRA)

This comparison resulted in selecting the AES technique to determine K and Na assays, and the AAS technique to determine Ca and Mg assays. Analyses of water insoluble minerals within the ore (i.e., insoluble minerals) were determined using ICP scan and WRA techniques.

Key data generated from the early metallurgical test program, in conjunction with test work performed in the later study phases was used to validate the process simulation model used for developing the Jansen processing flowsheets and mass balance.

## 10.2 Sample Representativeness

For the SGS metallurgical test program, seventeen core samples from the LPL ore horizon were provided to SGS for metallurgical and mineralogical characterization.

In total, 531 kilograms (kg) of samples were available for test work as 402 kg of slabbed core, plus an additional 129 kg of residual crushed core that remained after a quarter of the core from each ore horizon was crushed. After assay, samples were split out as required.

Metallurgical test work and chemical characterization was performed on the following samples, which provided a relatively high degree of representativity to the ore in the Jansen ore body and planned mining areas

- 17 individual drill holes
- Five regional composite samples
- One global composite sample

Detailed mineralogical analysis and chemical characterization was performed on the following samples:

- Designated Head sample
- Insoluble mineral seams 401 through 406 from head sample
- Head samples of regional composite samples, including a global composite sample
- Metallurgical products, including flotation concentrate and tailing samples

As received, the crushed reject samples were prepared separately according to their Jansen designations. Each of the reject samples from a drill hole were combined, crushed to -10 mesh (-1.70 millimetres) and rotary split into 1 kg charges for use during flowsheet development testing.

A single 1 kg charge from each drill hole was further riffled to produce a 150 gram sample that was submitted for chemical analysis.

Samples from each drill core were ultimately crushed to -8 mesh (-2.36 millimetres), then blended and homogenized. Two 5 kg subsamples from each Jansen sample were set aside for regional composite sample preparation. The remainder of the crushed and homogenized sample from each hole was rotary split into numerous 1 kg charges for use in subsequent testing. A representative sample from each Jansen composite sample was submitted for chemical analysis.

Global and regional composites designated as northern, eastern, southern, western, deep south, and global were formulated according to the geographical locations of the drill holes. Each composite sample was prepared by combining 5 kg of the core sample from each drill hole of the region. The composite samples were then riffled and rotary split into numerous representative 1 kg charges for use in subsequent testing.

Figure 10-1 shows a map of the Jansen ore-body with individual drill core sample locations and division of the ore-body into various regions by geography.

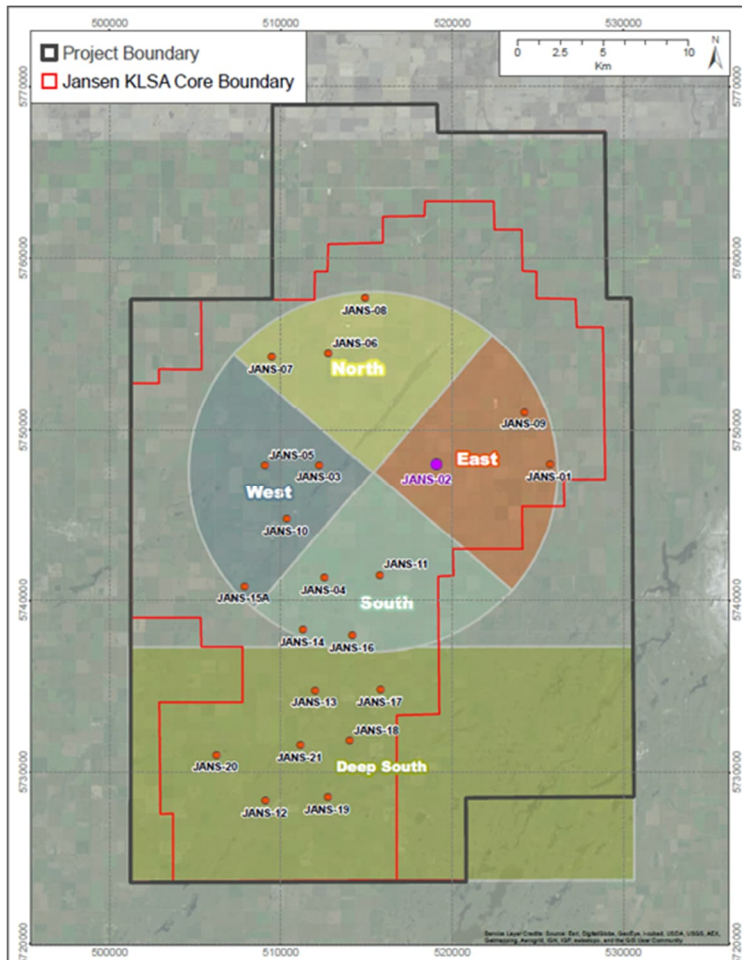

Figure 10-1: Geographical regions for metallurgical testing.

The SGS metallurgical program consumed most of the available drill core that could provide representative samples of the entire Jansen orebody that was part of the mining plan. It provided evidence that the Jansen ore body could be processed with froth flotation and at high recoveries. Further test work used other sources of ore that are discussed below.

For personal use only

Metallurgical test work that occurred between 2015 and 2017 had ore from two sources. The first was an existing Saskatchewan potash operation that supplied BHP Canada with ore. This sourced ore was of similar potassium chloride, sodium chloride, and water insoluble grades as Jansen ore. The particle size distribution of the sourced ore was also similar to anticipated Jansen run-of-mine ore. The sourced ore came from the UPL sub-member, while BHP Canada plans to extract ore from the LPL sub-member. The differences identified in the ore from these members are not, in the opinion of the Qualified Person, significant to the test program. In particular, the UPL has higher KCl and NaCl content variations, and can have lower water insoluble content. However, any BHP Canada test work involved water insoluble removal, so water insoluble content does not impact the flotation test work in any material respect. The sourced ore characteristic that differed from Jansen ore was the components of the water insolubles and the potential impact it could have on fine flotation. The Jansen process design has a water insoluble removal circuit that ensures minimal water insolubles arrive at coarse flotation. Therefore, it is the opinion of the Qualified Person, that the sourced ore was representative of the Jansen ore after undergoing water insoluble removal as per the Jansen design. Accordingly, it was determined to be reasonable for the sourced ore to be used for metallurgical testing for the coarse flotation circuit, as well as the desliming/attrition scrubbing circuit. The second ore source used for test work during this period was residual Jansen drill core. The Jansen ore used in this test work program was a blended sample of residual drill core cuttings made to be representative of the ore in the Jansen mine plan. The unit operations tested with this ore were attrition scrubbing, coarse flotation, fine flotation, and fine scavenger pneumatic flotation.

The 2018 metallurgical test program was conducted to further verify performance expectations in attrition-scrubbing, coarse flotation, fine flotation, scavenger pneumatic flotation, hot leaching of flotation tails, and to conduct further variability testing. The ore source for this test program was from the shaft sinking operations at Jansen. When the shaft sinking operations went through the LPL sub-member 600 tonnes of ore were taken to SRC. Separate piles of the ore were sized and assayed to allow the creation of a composite head sample that was representative of the Jansen mine plan ore. The composite head sample was representative in KCl, NaCl, and water insoluble content, as well as in particle size distribution. It is the opinion of the Qualified Person that this composite sample was representative of the future feed to the Jansen process plant, and was acceptable for this metallurgical testing program.

The ore from the shaft excavation operations was also used in equipment testing with vendors. The type of testing done was for equipment sizing or for performance testing, and was carried out with the vendors. The type of testing that was done was for wet screening, centrifuge performance, thickener sizing, pipe flow kinetics, and for bulk material handling equipment. In each case BHP Canada worked with SRC and the vendors to verify that the samples used in the test programs match the material balance expectations.

### 10.3 Laboratories

Test work, first conducted by SGS Lakefield to investigate potash recovery using core samples representing the LPL mining horizon of the Jansen orebody, was completed between December 2008 and June 2009. Subsequent flotation test work was conducted at the Eriez Flotation Division, USA in 2015. Process design verification work was completed by the Saskatchewan Research Council (SRC) in Saskatoon between August 2016 and August 2017 on the remaining

For personal use only

Jansen ore and a sourced ore. Additional supporting test work was completed in 2018 once the shaft sinking program reached the LPL sub-member and a bulk sample of Jansen ore was obtained. Both SGS Lakefield and SRC are independent, well respected labs that perform potash metallurgical test work for the mining industry. Both labs are ISO/IEC 17025 certified and use standards and procedures that are proven in the mining industry.

## 10.4 Relevant Results

### 2008/2009 Test work

Mineralogical and chemical characterization of head samples indicated a high degree of liberation of sylvite in all size fractions. Mineralogically limited grade-recovery curves, generated using QEMSCAN technology, indicated that a theoretical sylvite recovery of 90 per cent should be possible at the targeted grade of 60 % K<sub>2</sub>O. This has been supported by metallurgical flotation test work as demonstrated in the following sections.

Heavy liquid testing determined the liberation size of the Jansen ore as being slightly coarser than 1.18 millimetres (14 Tyler mesh), which is consistent with the sizes observed at other Saskatoon area potash mines.

Following two stages of attrition scrubbing and desliming, potash recovery using a flotation process has ranged from 89.3 per cent to 95.7 per cent during variability tests performed on individual core samples, and regional composite samples. Recovery efficiencies averaging 89.7 per cent with concentrate grades of 60.4 % K<sub>2</sub>O were achieved during locked cycle tests. These results were strongly aligned with GeoMet predictive analysis.

### 2015-2017 Test work

Test work was performed during this period to validate the process design changes, with the goal of verifying the same beneficiation in the process mass balance can be achieved. This involved verifying the concentrate grade and recovery could be achieved.

Attrition scrubbing and cyclone desliming tests were performed to verify scrubber design parameters and to prepare samples for flotation tests.

Flotation tests were performed to prove fine flotation using flotation columns, (Eriez, Flotation Division, USA; and SRC), coarse flotation using hydrofloats (Eriez, Flotation Division, USA; and SRC), and ultra-fine flotation using self-aspirated pneumatic flotation cells (SRC).

Metallurgical testing was performed to verify technology selection and initial performance expectations for coarse, fine, and ultra-fine flotation technology. This testing was conducted with sourced ore due to the limited availability of BHP Canada Jansen ore. Additional metallurgical testing was performed to verify the sourced ore was representative to the Jansen ore. The results of both the sourced ore and Jansen residual drill core verified the expected recovery, concentrate grade, and performance expectations of existing Jansen process design.

Ore characteristics that require discussion are water insoluble content, mineralogy, and liberation size. Water insoluble content is critical to mill design because the majority of the insolubles must be removed prior to flotation. An excess of water insolubles in flotation feed results in the water insolubles absorbing the majority of the collector (amine) resulting in poor KCl flotation. In addition, some insolubles are more hydrophobic, which cause them to resist desliming and consume more depressant reagents.

Neither sourced nor Jansen ore showed resistance to mechanical desliming. The sourced ore has a water insoluble content of 5 per cent to 5.6 per cent while the Jansen mine plan LPL member has a higher range of 5 per cent to 10.8 per cent, as seen in the BHP Canada design water insoluble grade of 7.44 per cent. This range was irrelevant to metallurgical testing because samples of both fine and coarse flotation testing were deslimed (water insolubles removed) prior to the testing to levels comparable to the BHP Canada design. Also, the BHP Canada desliming circuit is designed on metallurgical testing that was performed on BHP Canada Jansen ore, so it is robust enough to handle the higher water insoluble content.

Liberation size needs to be considered. The Saskatchewan potash industry sees differing regional liberation, but this is not the case between the UPL member and the LPL member ores. Benchmarking of available literature shows that both members achieve 95 per cent liberation at 1.2 millimetres. Metallurgical testing also shows very similar liberation curves for both LPL and UPL members. Therefore, it is the opinion of the Qualified Person, that use of UPL ore is acceptable to verify comparative technology selection for the BHP Canada Jansen processing facility. These tests demonstrated a range of grade-recovery points that support values used in the Jansen process design.

These metallurgical tests demonstrated a performance that supports the process design for potassium chloride recovery. Testing was performed with coarse, fines, and scavenger pneumatic flotation lab-scale equipment that is representative of that used in the plant design.

Reagent consumption levels during metallurgical test work were generally higher than those observed in industry, which is typical of laboratory scale testing. Reagent optimization work was performed during this period to further define consumption levels with Jansen LPL ore. However, standard Saskatchewan potash reagents were proven effective to achieve the required performance.

#### **2018 Test work**

In 2018 the Jansen shaft excavation program went through the LPL sub- member. This ore was saved, and the test work that was performed in 2015-2017 was performed one additional time on ore from the Jansen shafts. The whole cross section of the LPL was captured and a sample representing the Jansen mill feed was created as a head sample for assurance of previous test work programs. The test work program included attrition-scrubbing tests, rougher coarse flotation tests, scavenger coarse flotation tests regrind column flotation tests, fine column flotation tests, fine scavenger pneumatic flotation tests, and hot leaching tests of flotation tails. All of the 2018 tests verified the previous test work expectations, and confirmed the process design and performance expectations.

The metallurgical testing results were inserted into the process simulation and the resulting simulated recovery was 89.2%.

#### **10.4.1 Impact of ore variability on plant recovery**

Ore grade variability can impact plant recovery, and also the amounts of different reagents required. However, it is the opinion of the Qualified Person that the limited range of ore variability indicated in the mine plan can be easily managed with the existing process design.

## 10.5 Adequacy of Data and Non-Conventional Industry Practice

The Qualified Person validates that conventional practices were used in the metallurgical test work, process simulation, and evaluation of results. The only area that moved away from convention was in using a bulk ore sample for the final process design metallurgical test work. The initial 2008/2009 samples, that were representative of the whole orebody, were used up in the metallurgical testing at SGS that was based on the initial process design. As BHP Canada continued engineering, the design of the flotation circuits changed from bulk flotation to fines/coarse flotation. There was inadequate Jansen sample available for the complete metallurgical test work program, so purchased ore was used, and confirmation test work was done with a small amount of Jansen drill core available. The construction of the shafts also provided an additional opportunity to test the process design with Jansen ore. A bulk sample was obtained from the Jansen shaft excavation of LPL ore. This ore was analyzed to verify that it was geologically similar to the representative ore that had been drilled previously. The metallurgical test program was then duplicated using Jansen ore, and the Qualified Person validates that the results were as expected and previously reported.

## 10.6 Opinion on Influence for Economic Extraction

In the opinion of the Qualified Person, the data derived from the various sources detailed above is adequate for design of processing facilities and provides suitable product grade/recovery predictions for use in production rates. Confidence is further increased with the use of proven equipment in the potash industry and numerous Saskatchewan companies processing ore of similar composition.

## 11 Mineral Resources Estimates

The resource estimation process that BHP Canada follows is well established, consistent with industry practices, and is based on the integration of 3D seismic data and drill hole information. A set of procedures governs geological interpretation, estimation, and reporting of Mineral Resources including peer reviews. Documentation of the resource modelling work used for reporting is stored electronically in a secure centralised location. These documents contain information on deposit extents, geometry, detailed geological and geostatistical modelling, data preparation including compositing, and classification parameters.

The Mineral Resource qualified persons visited the sites regularly for program planning and reviews, gaining further understanding of the exploration program.

### 11.1 Key Assumptions, Parameters, and Methods Used

#### **Cut-off parameters**

The Mineral Resources are constrained stratigraphically, from the top of the 406 clay seam contact with the salt unit to a thickness of 3.96 metres. This thickness corresponds on average to the thickness measured from the top of the 406 clay seam to the bottom of the 402 clay seam. The style of mineralization and the mining method does not support selective mining based on quality cut-off values. The horizontal extent of the resource is defined by the occurrence of mapped anomalies and by a boundary that is 800 metres away from the lease edge.

#### **Mining factor**

The mineralization will be mined with continuous boring machines in a single pass within the stratigraphic bounds of the seam. During mining, it is expected that dilution from low-grade material cut from outside the stratigraphic markers may occur to maintain ground stability. The dilution is accounted for in the Mineral Reserves. Areas containing large numbers of hazardous geological features which do not allow practical extraction with the proposed mining method, are not included in the resource (Figure 7-2, Figure 11-2).

#### **Metallurgical factors**

Carnallite anomalies are mapped and included in the resource model with appropriate mineralogical parameters, as magnesium from the carnallite can interfere with ore processing. Insoluble content is also included as a resource model parameter because insoluble material is required to be removed during processing.

The moisture content of the LPL sub-member is estimated to be 0.3 per cent based on analytical testing.

#### **Environmental factors**

Brine waste from the processing operation planned to be disposed into an aquifer approximately 400 metres below the LPL mining horizon.

The solid salt waste from processing will be temporarily stored on the surface in a tailings management area, together with the insoluble fraction of the mineralization.

For personal use only

The estimation of these volumes is based on the resource and subsequent reserve model parameters, and environmental precipitation model. The related Environmental Impact Statement has been submitted to, and approved by, the Saskatchewan Ministry of Environment.

## 11.2 Geological Modelling

Geological modelling techniques employed by BHP rely on the close integration of drill hole data and 3D seismic information, including quantitative interpretation of seismic data.

Drill hole data interpretation is based on drill core and collected downhole geophysical data. Detailed mapping of geology relies on the identification of clay seams and related features and is based on visual core logging, geochemical assay data (BHP Canada and historical drill holes), and geophysical data from BHP Canada drill holes, including high-resolution acoustic televiewer data.

The 3D seismic data is first matched to drill hole data using standard geophysical techniques. This is followed by the mapping of geological horizons throughout the seismic volume and by the identification and mapping of structural geological features.

Quantitative interpretation of the 3D seismic data includes inversion of the seismic data using advanced seismic techniques to generate volumes of physical properties (Acoustic Impedance and Density) that reflect the mineralogical composition of the deposit and surrounding geology.

Mineralization domains are established based on information generated by the quantitative interpretation information. The domains within the LPL Mineral Resources include: the mineralization, areas of extensive no-potash anomalies, carnallite anomalies, and areas with structural features that pose a hazard to mining. The established domains are verified against drill hole data.

The geological model also includes geotechnical features present immediately above the mining horizon.

Drill hole and seismic data interpretations undergo an internal peer review process to ensure accuracy and consistency. Datasets are cross-checked and verified against each other to ensure the consistency of interpretation.

## 11.3 Block Modelling

Due to the horizontally continuous nature of the deposit, lack of structural complexity, and proposed extraction method, the resource is modelled on a 2D grid. The resource is divided into layers, or plies, based on geological factors and mining constraints. The primary and thickest layer contains the bulk of the resource and the highest grade. Additional thinner layers above and below are included to model the resource outside of the main zone. The schematic diagram of the model layering setup is shown in Figure 11-1.



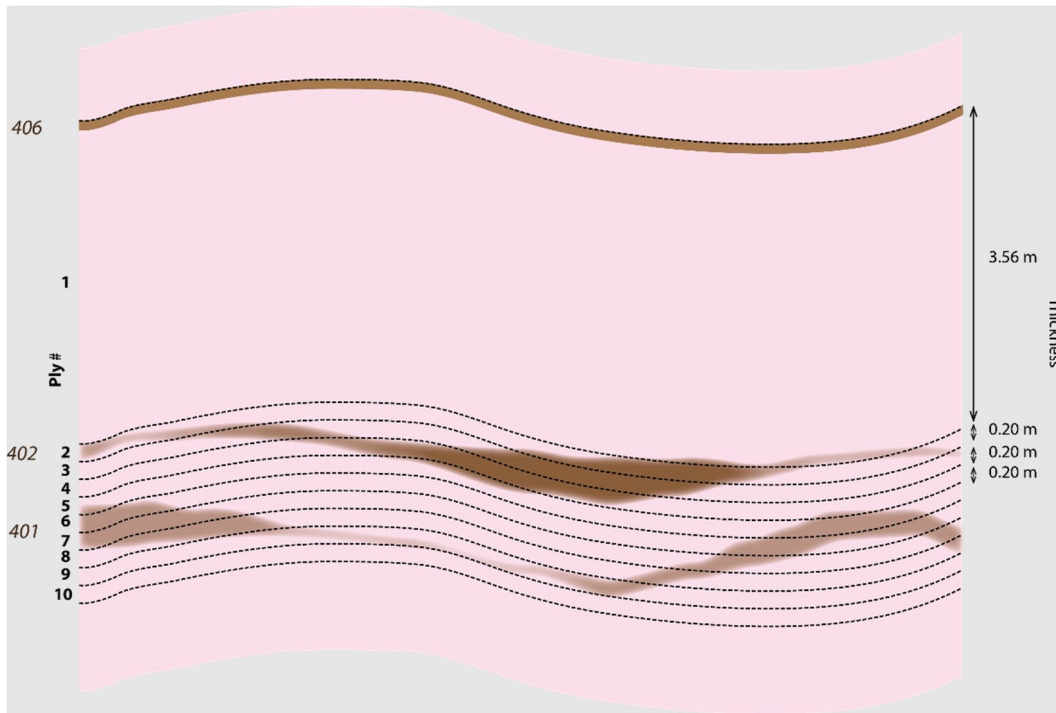

**Figure 11-1: Schematics of the block model set up for resource modelling. The model is referenced from the 406 seam, approximate location of the 402 and 401 seams are also shown for reference.**

Drill hole data preparation for resource modelling starts with identification and recording of clay seam locations, followed by the compositing of geochemical assays and physical property data from well logs over the defined model layers. For example, geochemical data at the wells from the top of the 406 seam down to 3.56 metres was composited by sample length weighted averaging and assigned to Ply#1. Intervals with missing data are automatically excluded from the process. Correlations between physical properties of the resource are established and noted for use during the resource estimation process.

Information from the inverted seismic volume is extracted for the LPL level. This information, together with the composited drill hole data, are used to generate the resource model. The modelling grid spatial dimension is set to 30 metres by 30 metres, which corresponds to the seismic survey bin size. This ensures that the full detail of the geological information, captured by the seismic survey, is used in the resource modelling process.

The estimation of qualities ( $K_2O$ ,  $MgO$ , insoluble) and density was performed using the co-located co-kriging approach, where the hard data are the composited drill hole information, and the soft data are the seismic information. This methodology allows the integration of high-resolution seismic data and sparse drill hole data without the loss of spatial resolution, and an increase in the confidence in the estimate due to integration of all available data.

Parameters for the estimation that describe the spatial continuity of the deposit, variogram range, nugget and sill, were obtained from the physical property map of the inverted seismic data. The sensitivity of the Resource Model to the uncertainty in the estimation parameters was tested and considered in the resource classification. The large and sparse drill hole spacing does not allow the estimation of spatial continuity in a reliable manner. The modelled deposit qualities ( $K_2O$ ,  $MgO$ , insoluble, and density) are estimated in a sequential manner to ensure the observed

For personal use only

correlations among them are preserved. In carnallite domains, the grade and physical property values are assigned to cells due to the limited data availability from drill holes. In no-potash domains the grade is assigned and physical property values co-estimated.

The moisture content of the potash was considered extremely low and showed little variability and was estimated by averaging the analytical results.

Geological features that are important for geotechnical consideration and are not imageable by the seismic methodology, are modelled based on drill hole intersections using geostatistical techniques. The modelling parameters used were established based on the recommendation of internal experienced subject matter experts.

Outside of the 3D seismic area the qualities and tonnages of the resource are estimated based on limited information. In the Qualified Person's opinion, the resource quality of the LPL is consistent over large areas, therefore it is reasonable to expect that the inferred resource quality and thickness is very similar to the measured resource. Hence, the reported qualities of the Measured Resource are assigned to the Inferred Resource. Geological features and anomalies identified on the 2D lines are used to exclude areas without mineralization and estimate the available tonnage based on the remainder area.

The Qualified Person considers that the resource estimation process is adequate to support the Jansen Mineral Resource estimates.

#### 11.4 Validation

Validation of the estimates include:

- visual and diagrams-based validation of models to check ranges, outliers, unexpected model behaviour
- global statistical comparison of volume weighted average cell grades to both raw and de-clustered drill hole grades
- comparison to previous resource estimates
- comparison of resource model predictions to post exploration drilling (Disposal zone testing and monitoring, brine injection) results
- comparison to regional resource information available outside of the Jansen lease

The resource quality data tabulated from different sources (Table 11-1) demonstrate that the estimated resource qualities from the resource model are well aligned with the exploration data. Based on the conducted validations it is the opinion of the Qualified Person that the resource model is appropriate for resource estimation and well supported by the available exploration data.

**Table 11-1: Comparison of drill hole, declustered (area weighted drill hole), and resource model K<sub>2</sub>O values from Ply#1.**

% K <sub>2</sub> O	Min	Max	Mean	Median	Standard deviation	# of data points
Drill hole data	22.3	30.7	26.4	26.3	1.8	38
Area weighted drill hole data	22.3	30.7	26.2	26.1	1.7	38
Resource model	22.3	31.5	26.2	26.3	0.3	805,230
<b>% Insoluble</b>						
Drill hole data	5.1	10.3	7.2	6.8	1.6	23
Area weighted drill hole data	5.1	10.3	7.1	6.6	1.5	23
Resource model	5.1	10.3	7.8	7.8	0.1	805,230

### 11.5 Cut-Off Grades Estimates

The LPL deposit is vertically confined by sharp stratigraphically defined mineralization boundaries and has spatially consistent quality. The material is believed to be economical within the defined boundaries based on pricing developed within the market study section of this report (Section 16). Due to this there is no cut-off grade applied.

### 11.6 Reasonable Prospect for Economic Extraction (RPEE)

The Inferred Mineral Resource extends around the Measured Mineral Resources Figure 11-2.

Key assumptions that support the potential economic extraction of the Inferred Resources include (but are not limited to):

- The resource will be mined with the same methodology as the current Mineral Reserves
- The Inferred Resource will be accessed by extending the current Mine Design
- The qualities of the Inferred Resource are expected to be closely aligned with the qualities of the Measured Resources that have been converted to Probable Reserves. This is supported by the already described consistent nature of the deposit and available, albeit limited in the Inferred Resources area, exploration data, and
- The modifying factors and price assumptions of the current Mineral Reserves are applicable to the Inferred Resources

It is the opinion of the Qualified Person that the major barrier that might hinder the potential extraction of the Inferred Resources are the unmapped anomalous geological features that are present within the Inferred Resource or the features that would prevent access to the Inferred Resource from the current Mine Design. Further exploration work, primarily 3D seismic, will be required in the Inferred Mineral Resource area to upgrade it to Measured category, and potentially to Mineral Reserves.

### 11.7 Resource Classification and Criteria

The classification of Mineral Resources takes in account two main factors:

- exploration data coverage (2D seismic, 3D seismic, and drill hole data)

For personal use only

- estimation uncertainty

There is no industry wide classification available for Saskatchewan potash. The classification below has been developed by BHP Canada.

### **Measured**

The resource estimate is classified as measured when it is based on a resource model that integrates 3D seismic and drill hole information and the estimated uncertainty of predicted tonnage and grade estimates are less than  $\pm 10$  per cent over an approximate annual production area.

### **Indicated**

The resource estimate is classified as indicated when it is based on a resource model that integrates 3D seismic and drill hole information and the estimated uncertainty of predicted tonnage and grade estimates are less than  $\pm 15$  per cent over an approximate annual production area.

### **Inferred**

The resource is classified as Inferred where the presence of the intact Prairie Evaporite Formation is confirmed by 2D seismic data with line spacing no wider than 4,000 metres and a sufficient number of drill hole intersections are available to infer the presence of the LPL sub-member.

The areal extent of the classified Mineral Resources is shown in Figure 11-2.

Zones within the tenure boundary that have not been classified represent areas where no mineralization is present due to the presence of carnallite or no-potash anomalies, areas of hazardous geological features, stand-off around tenure boundaries, or where BHP Canada does not have tenure rights.

For personal use only

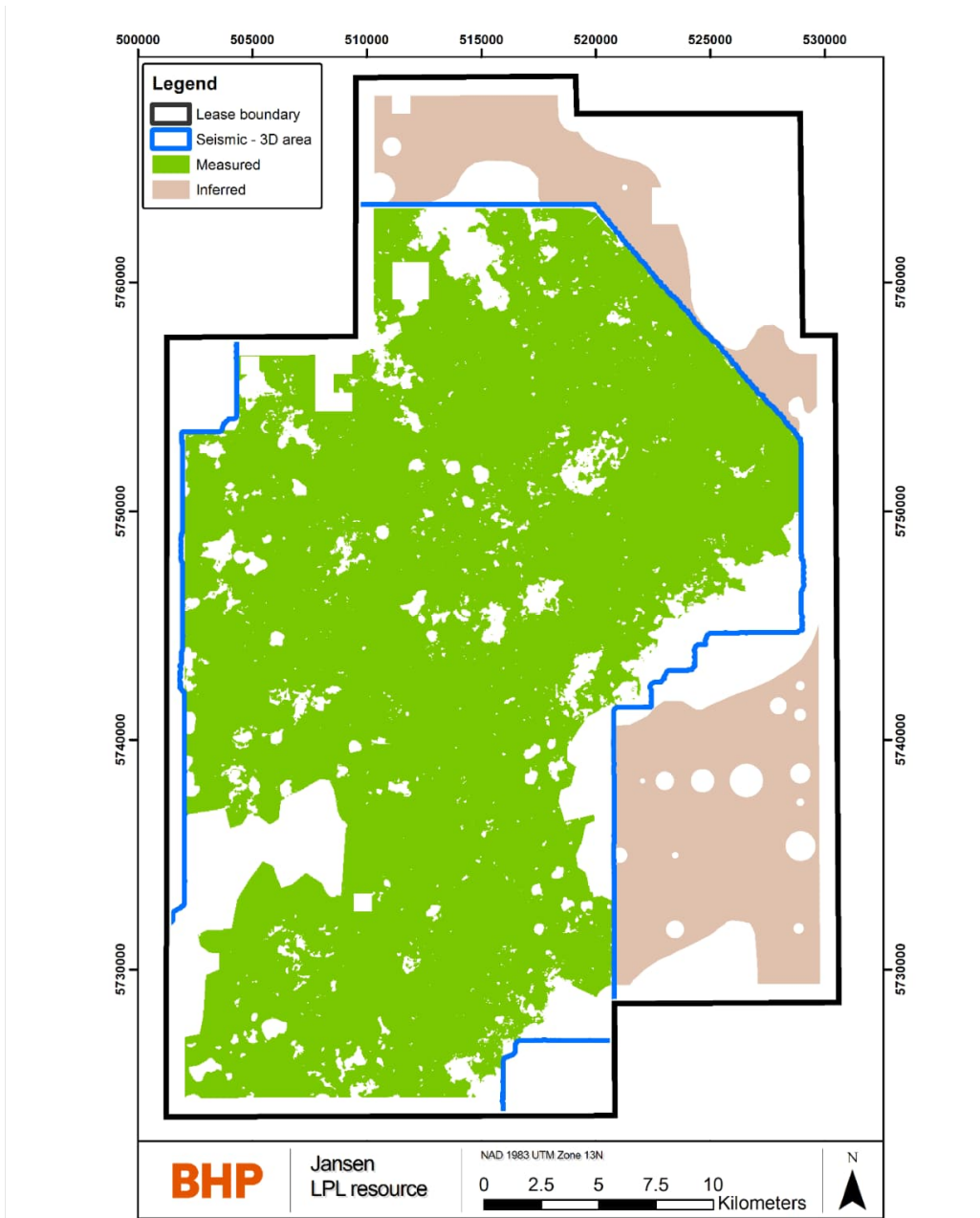

**Figure 11-2: Plan of the Jansen LPL classified Mineral Resource. Note that only Measured Resource has been converted to Mineral Reserves. White areas are not part of the resource.**

### 11.8 Uncertainty

#### Jansen Measured Resource

Uncertainty of the measured resource was assessed using statistical techniques. Models of the measured resource estimate with different probabilities were generated to quantify the uncertainty in resource qualities and geological features relevant for geotechnical considerations. These resource estimates were used to generate uncertainty estimates for the Mineral Reserves. Five measured resource models were generated:

- Minimum case – 99 per cent chance that the actual will equal or exceed the estimate
- Low case – 90 per cent chance that the actual will equal or exceed the estimate

For personal use only

- Mid case – 50 per cent chance that the actual will equal or exceed the estimate. Reported resource qualities are based on this estimate
- High case – 10 per cent chance that the actual will equal or exceed the estimate
- Maximum case – 1 per cent chance that the actual will equal or exceed the estimate

The sources of uncertainty for the measured resource qualities are:

- Finite number of physical samples obtained with drilling
- Relatively small size of the physical samples compared to the nature of the mineralization

The sources of uncertainty of geological features relevant for geotechnical considerations are:

- Finite number of core samples obtained with drilling
- Relatively large distance between drill holes compared to the features size

The outline of geological features identified on the 3D seismic image has uncertainties that are related to the spatial resolution of the seismic data. Uncertainties in these boundaries are not material to the measured resource as they have minimal impact on the reported tonnage. The impact of their uncertainty on mine design is considered in the Mineral Reserves.

#### **Jansen Inferred resource**

The area classified as inferred resource has limited exploration drilling data and only sparsely spaced 2D seismic lines. The inferred resource tonnage has a high degree of uncertainty as the extent and number of anomalous and hazardous geological features are unknown. The Qualified Person's opinion is that this uncertainty is adequately reflected in the inferred classification of the area.

### **11.9 Mineral Resource Statement**

Table 11-2 contains the statement of Mineral Resources for Jansen as at 30 June 2024. A detailed breakdown of the Mineral Resources by individual deposit, classification and material type is presented on an exclusive basis (i.e. exclusive of those Mineral Resources that have been converted to Mineral Reserves).

**Table 11-2: Jansen – Summary of Potash (Exclusive) Mineral Resources (as at 30<sup>th</sup> June 2024)**

Potash <sup>1,2</sup>	Mining method	Measured Mineral Resources				Indicated Mineral Resources				Measured + Indicated Mineral Resources				Inferred Mineral Resources			
		Tonnes	Qualities			Tonnes	Qualities			Tonnes	Qualities			Tonnes	Qualities		
		Mt	%K <sub>2</sub> O	%Insol.	%MgO	Mt	%K <sub>2</sub> O	%Insol.	%MgO	Mt	%K <sub>2</sub> O	%Insol.	%MgO	Mt	%K <sub>2</sub> O	%Insol.	%MgO
<b>Canada</b>																	
Jansen <sup>3,4,5,6,7,8,9,10</sup>																	
	LPL UG	-	-	-	-	-	-	-	-	-	-	-	-	1,280	25.6	7.7	0.08
<b>Total potash</b>		<b>-</b>	<b>-</b>	<b>-</b>	<b>-</b>	<b>-</b>	<b>-</b>	<b>-</b>	<b>-</b>	<b>-</b>	<b>-</b>	<b>-</b>	<b>-</b>	<b>1,280</b>	<b>25.6</b>	<b>7.7</b>	<b>0.08</b>

- (1) Mineral resources are being reported in accordance with S-K 1300 and are presented for the portion attributable to BHP's economic interest. All tonnes and quality information have been rounded, small differences may be present in the totals.
- (2) Mineral resources are presented exclusive of mineral reserves.
- (3) Jansen, in which BHP has a 100% interest, is considered a material property for the purposes of item 1304 of S-K 1300.
- (4) The point of reference for the mineral resources was in situ.
- (5) Mineral resources estimate was based on a potash price of US\$391/t (Real 2024 basis).
- (6) Mineral resources are stated for the Lower Patient Lake (LPL) potash unit and using a seam thickness of 3.96 m from the top of 406 clay seam.
- (7) Mineral resources are based on the expected metallurgical recovery of 88%.
- (8) Potash or sylvite (KCl) content of the deposit is reported in potassium oxide form (K<sub>2</sub>O). The conversion from KCl to K<sub>2</sub>O uses a mineralogical conversion factor of 1.583.
- (9) Mineral resources tonnages are reported on an in situ moisture content basis and was estimated to be 0.3%.
- (10) The sole purpose of the presented information above is to demonstrate the economic viability of the mineral reserves for the purposes of reporting in accordance with S-K 1300 only and should not be used for other purposes. The annual cash flow data was prepared based upon Pre-Feasibility-level studies and the historic average prices and costs described in this Technical Report Summary; it is subject to change as assumptions and inputs are updated. The information presented does not guarantee future financial or operational performance. The presented information contains forward-looking statements. Please refer to "Note Regarding Forward Looking Statements" at the front of this Technical Report Summary.

### 11.10 Discussion of Relative Accuracy/Confidence

Estimates of Inferred Mineral Resources have significant geological uncertainty and it should not be assumed that all or any part of an Inferred Mineral Resource will be converted to Measured or Indicated categories with further work. Mineral Resources that are not Mineral Reserves do not meet the threshold for reserve modifying factors, such as estimated economic viability, that would allow for conversion to mineral reserves.

In the Qualified Person's opinion, the relative accuracy and therefore confidence of the resource estimates is deemed appropriate for their intended purpose of global resource reporting and medium to long-term mine planning studies. The factors influencing the accuracy and confidence as stated in Section 11.7 are taken into consideration during classification of the model and are therefore addressed by the Qualified Person in the attributed resource classification.

## 12 Mineral Reserve Estimates

The Jansen Mineral Reserves are summarized from the approved Life of Asset (LoA) plan for the Jansen mine-was completed in Fiscal Year 2024 (FY24) in accordance with the BHP requirements for Major Capital Projects. The Jansen potash project mineral resource model and mineral resource estimate have been used for the mine planning and conversion to the Mineral Reserves as at 30 June 2024. The LoA plan incorporates:

- Scheduling material movements from designed final mining excavation plans with a set of internal development sequences, based on the results of the resource evaluation process;
- Planned production from scheduled deliveries to processing facilities, considering metallurgical recoveries, and planned processing rates and activities;
- Capital and operating cost estimates for achieving the planned production;
- Assumptions for major commodity prices and other key consumable usage estimates;
- Revenues and cash flow estimates;
- Financial analysis including tax considerations.

Mineral reserves have been evaluated considering the modifying factors for conversion of measured and indicated resource classes into proven and probable reserves. The details of the relevant modifying factors included in the estimation of mineral reserves are discussed in the following section.

### 12.1 Key Assumptions, Parameters and Methods Used

The deposit is relatively two-dimensional (laterally extensive and relatively thin) and is “soft rock” thus amenable to mining using track-mounted boring machines, roof-mounted or floor-mounted conveying systems, and ancillary rubber-tired mining and transport equipment. The primary method of extraction is continuous mining using long room and pillar method within the LPL sub-member.

The mine is designed to reduce the risk of water inflow from overlying aquifers and to provide room stability for safe working conditions and managed through varying the extraction ratio relative to the life of the entry. Production panel mining extraction ratio ranges between 41 per cent and 44 per cent and long term travelways are planned to have a reduced extraction ratio of approximately 10 per cent for stress shielding. Further reduction in extraction ratio occurs with the placement of panels relative to one another to reduce the influence of stress. This is achieved through establishing pillars between active and future zones of mining, which is shown in Figure 12-1. Pillar dimensions are noted in Table 12-1. Production mining room widths are expected to be 12 metres.

The geotechnical parameters have been supported and developed by external consultants and the Jansen Geotechnical Qualified Person. The parameters were developed after empirical and numerical modelling analysis, including benchmarking studies of the deposit assessing; the geological conditions, depth, extraction ratio, extraction rates, and expected useful life of the entries. The pillar widths are based upon the study outcomes and recommendations, and guide the mine design, with depth and overburden type forming the calculation basis of the in situ stress for the Prairie Evaporite. Pillars within the mining horizon are used to enable safe mining of



entries, maintain entry stability throughout their required life, and maintain the integrity of the overlying strata.

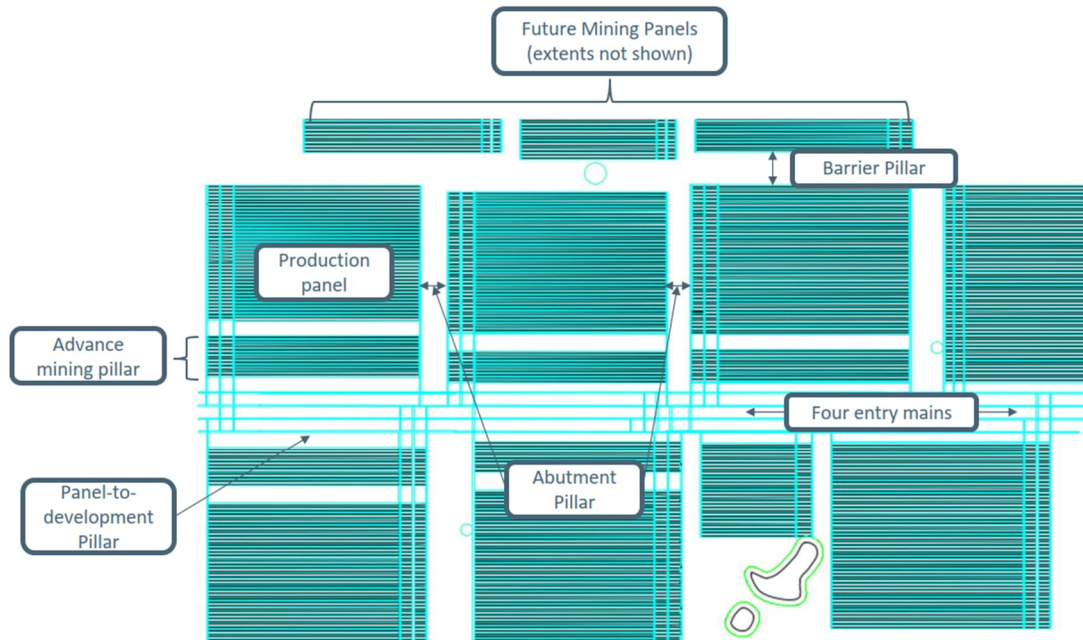

N.T.S.

Figure 12-1: Naming convention and typical arrangement of pillars

Table 12-1: Mine Design Modifying Factors

Modifying factor	Pillar Distance (m)	Note
Shaft (pillar diameter)	4,000	Production mining exclusion zone
Mainline development	100	
Block development	60	
Advance mining	500	Function of distance to end of mining block
Panel to development	150	
Abutment	150	
Barrier	300	
Town limit	500	Standoff from demarked town limit
Collapse Anomaly– (Severity Class 1, 2, 3)	300, 300, 50	Refer to Section 6.4 and Figure 7-22,
Drill Holes – Historic, BHP (pillar diameter)	180, 100	Historical refers to all holes pre 2008
Brine disposal well (pillar diameter)	200	
Production panel pillar	15 to 17	Depth dependent

Mechanically-anchored rock bolts are the planned ground support method for the mine. The support design is based on overlying salt beam thickness and/or a change in material characteristics. The salt beam thickness is the distance from roof to the next overlying clay seam or plane of weakness. When the overlying strata is thinner than the practical limit of rock bolt

For personal use only

ground support, the strata will be excavated and become part of the processing stream as dilution. The design of the mine excavations is not driven by roof beam thickness prediction models. Roof beam thickness thresholds are listed in Table 12-2. The Mineral Reserve estimate is considered to be fully diluted for reporting purposes and a reference point of Run of Mine ore delivered to the Mill for processing.

**Table 12-2: Roof beam thickness thresholds**

Entry Type	Cut	Bolt	Planned Overcut
Production	0 to 30 cm	30 to 50 cm	10 cm
Development	0 to 50 cm	>50 cm	10 cm

The mine design shapes are outlined in two dimensions with their position optimised on a lease wide scale to maximise the conversion of mineral resources, production tonnes to the development required, and capital efficiency of the bulk materials handling system. The mine design shapes are populated with the ply information from the resource model characteristics and the respective roof dilution guided by the aforementioned roof beam thickness thresholds and loaded into the mine planning model. The thickness of the planned overcut from the target roof strata is expected to be 10 centimetres.

Major geological features such as collapse anomalies, carnallite, and large leach areas indicate the areas where mine excavations are to be avoided. Some smaller scale anomalies are included within the mine design and therefore in plant feed. This dilution is unavoidable since no waste handling system exists. The combined dilution tonnage of planned carnallite zones and no-potash anomalies is less than 10 million tonnes.

The excavation sequence (Figure 13-5) is determined within the mine planning model. The mine layout is divided into four districts, with active mining planned in three districts at any given time. Mining will begin in the East, North, and West Districts. The mine schedule does not plan for losses through abandonment of mining rooms. The tonnage and volume based consumables from the mine planning model are used in the calculation of the mine operating expenses, and serve as the trigger for maintenance based outages such as equipment rebuild cycles.

The mine planning model is limited in the breadth of scope, and as a result simplifies the operation of the hoist and processing plant, and excludes all activities further downstream of the processing plant. The Production Volume Estimate (PVE) is a simulation model of the entire Jansen Value Chain; mine face through to ship loading which considers variability and correlation within and between activities. The Expected production rates are a result of the PVE model and represent the most likely production rate of the entire Jansen Value Chain. The mine planning model is explicitly linked to the resource model and generates a deterministic ore grade profile which is used in the Economic Evaluation. The PVE model is not linked to the resource model and therefore cannot produce a corresponding grade profile to the Expected production.

The estimation of the Mineral Reserve does not include the use of Inferred Resources or Indicated Resources.

As described in Section 16, the through-cycle price average is estimated using Nutrien Ltd. (nee Potash Corporation of Saskatchewan Inc.) quarterly published offshore and onshore realised

prices during 2008-2023. A longer duration is considered to establish the through cycle average price, with the upswing average from 2008 to 2013, a downside average from 2014 to 2020, and the emergence of a 'Fourth Wave' of pricing beginning in 2021 as shown in Figure 16-3. An average price calculation method was used to preserve the upswing and downswing pricing in the pricing cycle. After accounting for product type and geographical sales mix to a Jansen operation equivalent, the average price is US\$391/t FOB mine (Saskatoon, Real 2024 basis). Price assumptions are discussed further in Section 16.

In this Qualified Person's opinion, it is appropriate to the commodity to use a through-cycle average price trend to estimate a reasonable reflection of the long-term potash market fundamentals. The drivers of the Potash market are more foundational and largely attributed to population, diet, and soil fertility. Short term pricing swings are largely attributed to weather, government policy, and local farm economics.

The operating cost estimate for Jansen, outlined in Section 18.2, is developed to a pre-feasibility level of accuracy. The estimate includes all costs spanning from the mining face underground to the loading of product to rail at the site. The majority of the direct capital cost estimate is based on engineering designs, and the majority of the direct bulks and equipment supply pricing are based on budget pricing from the market. Operating expenses estimates, sustaining capital, and project capital cost estimates are detailed in Section 19.

## 12.2 Cut-Off Grades Estimates

The orebody gently undulates over large distances, has well defined boundary conditions, and has a reasonably consistent ore grade over the Jansen lease with mining occurring on a single level. The cut-off grade has been estimated at 8.1 %K<sub>2</sub>O and considers mining 1,070 Mt over the life of the mine using the price and cost data outlined in Section 19 - Economic Analysis, and mid case mining parameters shown in Table 12-6. The cut-off grade is a calculated value within the economic analysis model. The economic model intakes the expected production profile shown in Figure 13-4, and sequentially reduces the run of mine ore grade over the life of mine, until the calculated Net Present Value equals zero.

The Minimum range case, shown in Table 12-6, has aggressive overcut conditions with a complete removal of all Shadow band types when present, 20 centimetre overcut in all instances, and a fixed 4 metre production room cut height which cuts low grade material. Achieving a run of mine grade that approaches the calculated cut-off grade is believed to be unlikely and holds the assumption that no mitigating actions to improve grade are taken or successful over the life of mine.

The economic viability of the Mineral Reserve has been tested against a range of commodity prices, with detail available in Section 19. The basis for the price forecast is outlined in Section 16 of this report.

**Table 12-3: Assumptions / Estimates for Cut-off Grade<sup>1</sup>**

Assumption / Estimate	Units	Value	Comment
Potash price	US\$/t	391	2024 Real basis. FOB Mine
Exchange rate CA\$/US\$		1.30	3 year historic average (Jul '20 through Jun '23)
Mill recovery	%	88	
Mining cost	US\$/t	1	
Processing cost	US\$/t	9	
Administration and other cost	US\$/t	23	
Fixed Costs	US\$/t	43	
Sustaining Capital	US\$/t	13	
Total cost	US\$/t	90	
Discount Rate	%	7.0	
Cut-off grade	% K <sub>2</sub> O	8.1	

**Table 12-4: List of Cut-offs Currently in Use**

Area / Deposit	Ore Type	Mineral Reserve Cut-off grade	Comments
Jansen	Potash	8.1 % K <sub>2</sub> O	

Ranging occurred throughout the Jansen Project development, with the latest exercise independently facilitated with a broadened external industry engagement, constraining the timeframe considered to remove the effects of mitigations, and aligned to BHP's Ranging Guidelines. The Key Value Drivers (KVDs) of the project are found in Table 12-5. A mine schedule was developed for the Minimum, Low, High, and Maximum range scenarios, which determined the tonnes and grade per period, and the total minable tonnes. A summary of ranged dilution values and resource grade are shown in Table 12-6.

1 - The sole purpose of the presented information above is to demonstrate the economic viability of the mineral reserves for the purposes of reporting in accordance with S-K 1300 only and should not be used for other purposes. The annual cash flow data was prepared based upon Pre-Feasibility-level studies and the historic average prices and costs described in this Technical Report Summary; it is subject to change as assumptions and inputs are updated. The information presented does not guarantee future financial or operational performance. The presented information contains forward-looking statements. Please refer to "Note Regarding Forward Looking Statements" at the front of this Technical Report Summary.

**Table 12-5: Jansen Project Key Value Drivers**

Area	Key Value Driver	
Mine	Borer Cutting Rate (tph) Borer Failure Rate (%) Extendable Belt System (EBS) Failure Rate (%) Conveyor Failure Rate (%) Shift Change (hrs/day)	Relocation Duration (hrs/event) Turnaround Relocation (hrs/event) Bit Change Duration (hrs/event) EBS Extension Duration (hrs/event)
Hoist	Scheduled Downtime (hrs) Unscheduled Downtime (hrs)	Skip Cycle Time (seconds / cycle)
Processing	Dilution (%K <sub>2</sub> O loss) Scheduled Downtime (hrs) Unscheduled downtime (hrs) Ore feed rate (tph)	Dissolution losses (%) Fines flotation recovery rate (%) Coarse rougher flotation recovery rate (%)
Rail	Overseas – Transit cycle time (hrs)	Overseas – Non-transit cycle time (hrs)
OPEX	Mine Production (# FTE) Mine Maintenance (# FTE) Surface Maintenance (# FTE) Mine Production (\$/FTE) Mine Maintenance (\$/FTE) Surface Maintenance (\$/FTE)	Operations Support (\$/FTE) Indirect labour (\$) Mine Sustaining Capital (\$) Process Sustaining Capital (\$) Export Rail Freight & Fuel (\$)

**Table 12-6: Range cases – Grade summary**

KVD	Min (P99)	Low (P90)	Expected	Mid (basis for Mineral Reserves)	High (P10)	Max (P1)
Shadow band	100% cut	50% cut	N/A	Dev. Cut 0-50cm; Prod. Cut 0-30cm	Cut 0-20cm	Bolt all
Global overcut (cm)	15	15	N/A	10	5	0
Extraction Ratio (%)	30	37	N/A	44	50	70
Inter Panel pillar (metres)	300	150	N/A	100	100	50
Inter block pillar (metres)	300	300	N/A	300	100	50
Panel room length (metres)	400	800	N/A	1,800	2,500	6,000
Resultant Dilution (%K <sub>2</sub> O)	4.0	3.6	1.8	1.2	0.9	0.7
Resource grade (%K <sub>2</sub> O)	25.3	25.7	26.2	26.1	26.7	27.0
Resultant RoM (%K <sub>2</sub> O)	21.3	22.1	24.8	24.9	25.8	26.3

### 12.3 Reserves Classification and Criteria

The Probable Mineral Reserves are comprised of Measured Mineral Resources because the targeted mineralised zone has not been exposed to any significant degree to validate the modifying factors. It is noted that the Mineral Resources are exclusive of Mineral Reserves. At the time of writing, the LPL has been exposed in the wall of each shaft and no LPL lateral development has been completed to date. Given the minimal amount the orebody has been physically revealed, the pillar sizes, pillar recovery, and the overlying roof beam thickness which correlate to the total recoverable tonnes and mining dilution are uncertain.

## 12.4 Mineral Reserve Statement

The Mineral Reserves outlined in Table 12-7 are based upon a Measured Resource noting the Mineral Resources are reported on an exclusive basis from the Mineral Reserve. The Mineral Reserves are acknowledged to be at a Probable level of confidence given the underground development to date is not sufficient to validate the modifying factors.

In the opinion of the Qualified Person it is appropriate to select the lower confidence level of Probable given the limited exposure of the orebody.

**Table 12-7: Jansen – Summary of Potash Mineral Reserves (as at 30<sup>th</sup> June 2024)**

Potash <sup>1</sup>	Mining Method	Proven Mineral Reserves				Probable Mineral Reserves				Total Mineral Reserves			
		Tonnes		Qualities		Tonnes		Qualities		Tonnes		Qualities	
		Mt	%K <sub>2</sub> O	%Insol.	%MgO	Mt	%K <sub>2</sub> O	%Insol.	%MgO	Mt	%K <sub>2</sub> O	%Insol.	%MgO
<b>Canada</b>													
Jansen <sup>2,3,4,5,6,7,8,9</sup>													
LPL	UG	–	–	–	–	1,070	24.9	7.5	0.10	1,070	24.9	7.5	0.10
<b>Total potash</b>		<b>–</b>	<b>–</b>	<b>–</b>	<b>–</b>	<b>1,070</b>	<b>24.9</b>	<b>7.5</b>	<b>0.10</b>	<b>1,070</b>	<b>24.9</b>	<b>7.5</b>	<b>0.10</b>

(1) Mineral reserves are being reported in accordance with S-K 1300 and are presented for the portion attributable to BHP's economic interest. All tonnes and quality information have been rounded, small differences may be present in the totals

(2) Jansen, in which BHP has a 100% interest, is considered a material property for the purposes of item 1304 of S-K 1300.

(3) The point of reference for the mineral reserves was ore as delivered to the mill for processing.

(4) Mineral reserves estimate was based on a potash price of US\$391/t (Real 2024 basis).

(5) Mineral reserves estimates cut-off is a function of mining parameters and seam thickness. The calculated cut-off grade from economic modelling where the mine plan would be break-even is 8.1% K<sub>2</sub>O.

(6) Mineral reserves are based on the expected metallurgical recovery of 88%.

(7) Potash or sylvite (KCl) content of the deposit is reported in potassium oxide form (K<sub>2</sub>O). The conversion from KCl to K<sub>2</sub>O uses a mineralogical conversion factor of 1.583.

(8) Mineral reserves tonnages are reported on an in situ moisture content basis and was estimated to be 0.3%.

(9) The sole purpose of the presented information above is to demonstrate the economic viability of the mineral reserves for the purposes of reporting in accordance with S-K 1300 only and should not be used for other purposes. The annual cash flow data was prepared based upon Pre-Feasibility-level studies and the historic average prices and costs described in this Technical Report Summary; it is subject to change as assumptions and inputs are updated. The information presented does not guarantee future financial or operational performance. The presented information contains forward-looking statements. Please refer to "Note Regarding Forward Looking Statements" at the front of this Technical Report Summary.

## 12.5 Discussion of Relative Accuracy/Confidence

In the opinion of the Qualified Person, areas of uncertainty that may materially affect the Mineral Reserve estimate include (but are not limited to):

- The Jansen mine is not yet producing and has no operational performance data
- Price and other economic assumptions
- Ability to continue sourcing water from the Saskatoon South East Water Supply
- Ability to maintain environmental and social license to operate
- Changes in assumptions related to the mine design evaluation including geotechnical, mining capability, processing capabilities, and metallurgical recoveries
- Potash is the sole commodity type extracted or considered.

The Jansen mine is not yet producing and therefore actual results are uncertain and have not yet been reconciled against the planned performance. A Production Volume Estimate (PVE) model was developed and applied across the entirety of the value chain in an effort to understand the impact of uncertainty. The PVE model is a mine-face-to-market model of the integrated chain for Jansen. Monte Carlo simulations were performed to quantify the uncertainty of value chain inputs on the integrated capacity.

There remains uncertainty with respect to the validation of the production panel pillar sizing. Production panel mining represent approximately 90 per cent of the Mineral Reserve, with development entries comprising the remaining approximate 10 per cent. The pillar sizes have been selected to mimic stress conditions that are successfully managed in the Saskatchewan basin. The geotechnical instrumentation installation, data collection program, and numerical modelling validation plan exists and is planned to begin with lateral development start.

Managing mining face dilution via the roof beam thickness thresholds will evolve with time and ground performance data collection and analysis. Sensitivity ranging has been performed.

The mining recovery is currently planned to be 100 per cent, and includes the mining of advance mining pillars; mining and transport losses are not accounted for. Upon retreat from a mining block, the larger advance pillars will be mined and subject to the abutment pillar sizing. Advance pillar mining represents 15 Mt of the mineral reserve and mining of this type occurs steadily over the mine life. There is a level of uncertainty regarding the mining of the rooms within the advance mining pillars. The pillars have been designed such that the stress conditions are favourable for excavation. The recovery of the advance mining pillars does not have a material impact to the economic viability of the mineral reserve.

The shaft liners have a design life of 70 to 80 years. Planning for and adherence to shaft maintenance is a critical component to extend the life of the shaft liners. Shaft liner monitoring instrumentation exists, and can provide an idea of when additional maintenance may be required. The shaft has been identified as a critical asset.

In the Qualified Person's opinion, the relative accuracy and therefore confidence of the reserve estimates is deemed appropriate for their intended purpose of global Mineral Reserves reporting and short to long-term production planning. The application of modifying factors affecting the accuracy and confidence as stated in Chapter 11 are taken into consideration during classification of the model and are therefore addressed in the Probable Mineral Reserve classification.

### 13 Mining Methods

#### 13.1 Selected Mining Method

At Jansen, the LPL ore zone was selected as the target mining zone. The LPL ore zone offers several advantages over the UPL sub-member and Belle Plain Member. Refer to Figure 6-4. Based on the available information over the Jansen lease, the LPL has a more consistent and greater thickness, a thicker overlying salt beam for long-term stability of the overlying strata and mine workings, and a higher and more consistent grade than the UPL ore zone.

The planned mining method is long room and pillar utilizing continuous mining equipment for excavation. Refer to Figure 13-1. The mining method was selected given the deposit is stratified, generally flat lying, and suitable for mechanical cutting as the means for excavation. The thickness and the grade intervals of the LPL zone in the Jansen lease area do not vary significantly.

The mine is divided into four districts, which contain mining blocks comprised of development entries and production panels. Excavated ore is transported via conveyor network to the shaft for hoisting and subsequent processing. Development mining takes place within the LPL zone. Production room mining is completed in a two pass routine, where pass 1 is excavated from the panel travelway to the turn-around entry while a temporary conveyor system is installed as the mining face advances. Pass 2 follows the excavation wall from pass 1, and reclaims the conveyor as the mining face advances back towards the travelway. This process is repeated until all rooms have been mined in a panel.

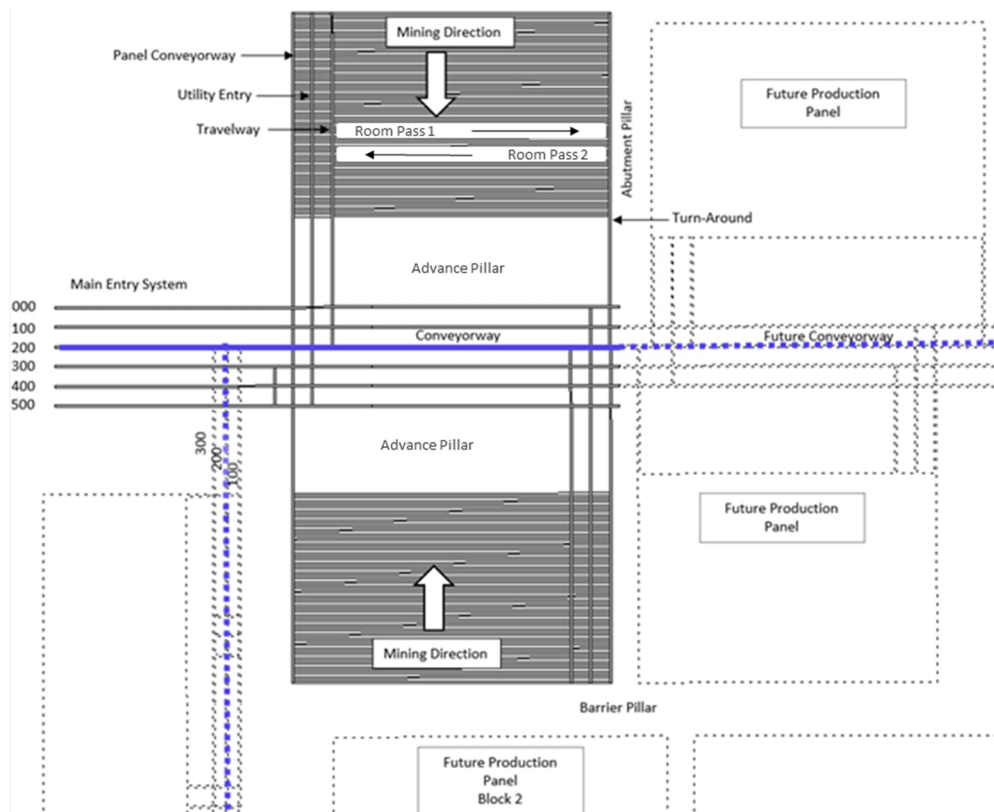

Figure 13-1: General arrangement of development access and production panels

For personal use only



## 13.2 Additional Parameters Relevant to Mine Designs and Plans

As discussed above, the Dawson Bay aquifer is in close proximity to the mining horizon (Figure 7-8). The mine is designed to avoid the occurrence of mine inflow by designing the extraction ratio such that the integrity of the overlying strata remains intact. The Dawson Bay Formation in the Jansen area is expected to have low permeability or relatively low inflow deliverability potential but may pose potential risk of water inflow if hydraulically connected to vertically adjacent aquifers. In an effort to reduce the risk of a mine threatening inflow, the Dawson Bay Formation is treated as though it has a high permeability. The hydrogeological models developed contribute to the risk analysis of water inflow to the mine and mine dewatering design (refer to Section 15.8.4 below).

### 13.2.1 Geotechnical Models

Geotechnical models have been developed to assess the long-term and short-term effects from mining over the life of the entries. Considerations were given to ground stability, management of mine induced inflow and surface subsidence.

Maintaining the integrity of the Second Red Beds, is one consideration for the assessment of long-term stability. Conducting geotechnical model assessments on the Second Red Beds planned mine designs has provided confidence that mining induced damage will likely not occur to the Second Red Beds or Dawson Bay limestones. These model assessments confirm assumptions that with expected local geology, fractures between the mining rooms within the Prairie Evaporite are not created connecting the mining rooms with the overlying aquifers within the Souris River, Duperow and Mannville. Maintaining the integrity of the overlying shale, limestone and halite units act as a protective barrier from risk of brine inflow. An additional control to manage the brine inflow risk, is pillar size which is controlled to reduce impact from subsidence. Zones that have the potential to contain brine, such as water bearing Dawson Bay, are marked as exclusion zones and can be avoided to further reduce the risk of potential brine inflow. Modelling of pillar design is critical to ensure mining induced fracturing of the overlying strata does not occur.

Determining the integrity of the Second Red Beds involves looking at the strength of the member versus the mining induced stresses with time. The factor of safety while mining within the LPL mining horizon, is expected to exceed 2.5. The factor of safety while mining in UPL entries is expected to exceed 1.4 with the difference in factor of safety primarily attributed to proximity of the Second Red Beds from the mined horizon.

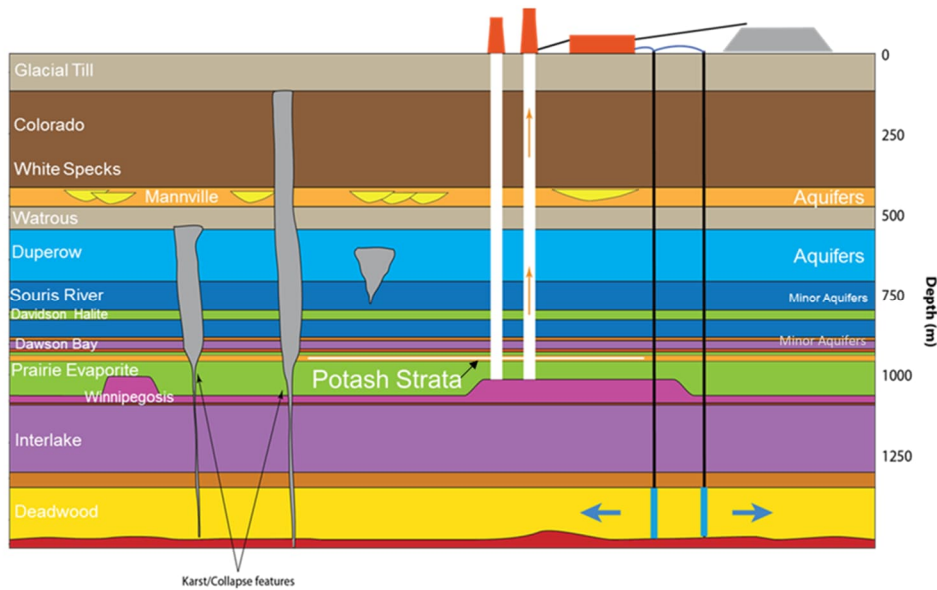

**Figure 13-2: Schematic of Local Geology, Aquifer locations in relation to Potash Strata**

The stability of the mined entries is controlled through room and pillar size and extraction ratio in conjunction with geological and operational considerations. Table 12-1 shows the parameters used to develop the life of mine design, whereas Table 12-2 shows the decisions in response to geological and operational outcomes. The LPL ore zone within the mine design footprint dips relative to surface 130 metres from the northeast down to the southwest (Figure 7-5). Due to increase in overburden weight, the magnitude of stress is expected to also increase in the southwest. The operational response from the increase in in situ stress is to change the pillar size within panels resulting in reduced extraction, this is shown in Figure 13-3. An exception is shown for early mine life panels, where pillar size is planned for 17 metres, to enable early ground calibration in a more conservative design.

For personal use only

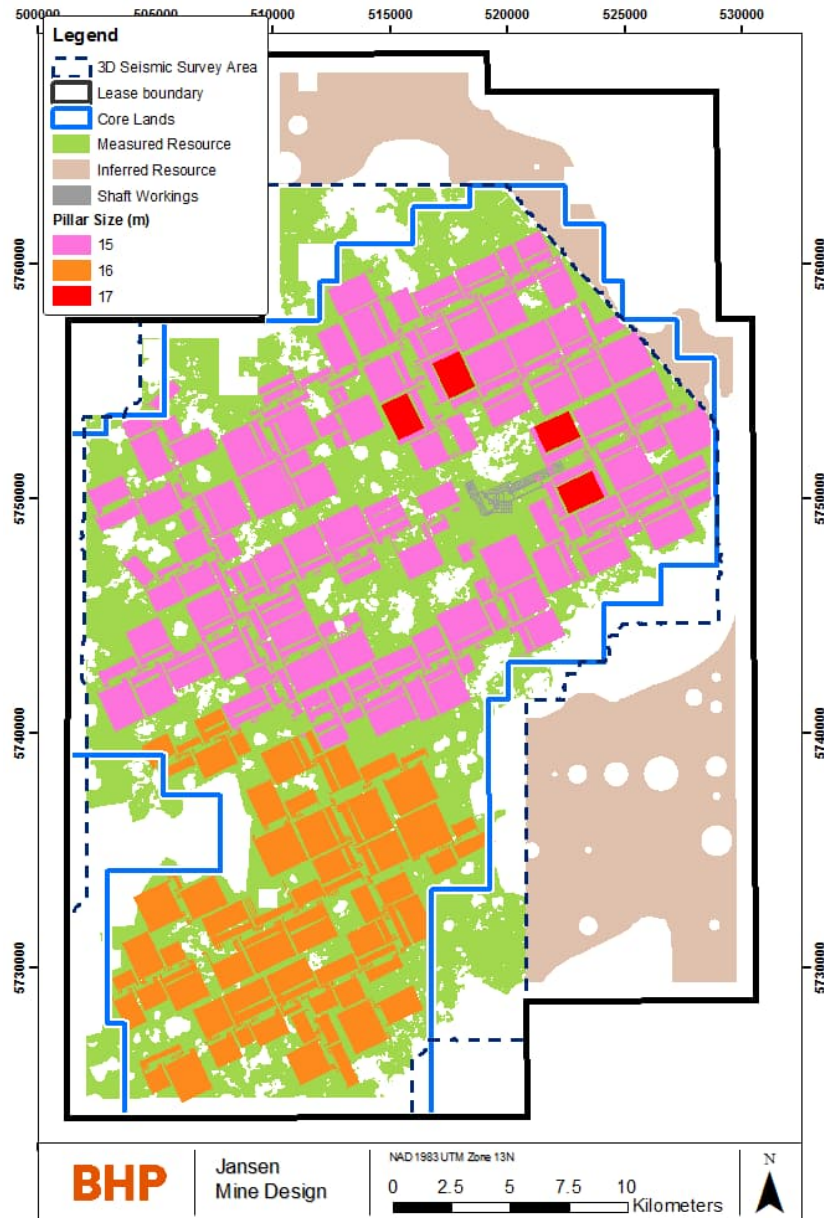

**Figure 13-3: Change in panel extraction with increasing depth**

The geotechnical model consists of analysis completed for all expected designs for the Jansen mine. Jansen specific mine designs that have been evaluated include shaft pillar life of mine entries in the UPL and LPL mining horizons at varying dimensions, raw ore bin, surge bin and ramps. Modelling external to the shaft pillar, was conducted on a variety of production panel and development entry layouts, including various room and pillar sizing.

In the Qualified Person’s opinion, the Jansen mine design is geotechnically feasible. The design is supported through documented similarities with the neighbouring Nutrien Lanigan mine, located approximately 40 kilometres west of the Jansen mine site, which has been in operation since 1968. There are differences between those mines such as the excavated production room height and corresponding pillar sizes. However, both mines share similar area extraction ratios which is a common metric for assessing overall geotechnical conditions for entries. Furthermore, the Jansen design utilizes a narrower room width and with a planned reduced duration in room, exposure to geotechnical risks is expected to be reduced.

For personal use only

There is uncertainty with the geotechnical model, particularly with pillar response, regionally for the Jansen mine as test work in the ore zone was primarily completed for one drill hole. The viscoelastic plastic response was tested on Jansen drill core, including samples from the UPL to Belle Plaine Member. Analysis of representative intervals from the drill hole were tested in relation to proposed mine plan design. Testing from nearby exploration drill holes provide additional confidence in Jansen modelling parameters. To address the uncertainty, a ground monitoring plan for shaft pillar mine development has been developed to build upon the geotechnical database and calibrate against the existing geotechnical model prior to panel development.

### 13.2.2 Hydrogeological Models

The brines in the aquifers adjacent to mine levels are found to be saturated to a varying degree in potash mines. Undersaturated brines may pose substantial risk to potash mining. Even saturated brines may still have the ability to dissolve rock salts causing erosion of the rock and fluid movement resulting in potential mine inundation (i.e., groundwater inflow into a mine). Therefore, inflow is considered a material risk to the Jansen mine.

The Dawson Bay Formation is deemed to pose a potential risk of water inflows into a mine due to its water bearing potential and close proximity to the mining level (Figure 7-2 and Figure 13-2). Porosity and formation water content in the formation are found to be variable across the Jansen mine area despite the stratigraphy being uniform and consistent. The drill hole geophysical logs and seismic data found no high porosity areas in the Dawson Bay carbonate that overlies and is closest to the planned mining zone. If the Dawson Bay Formation is hydraulically connected to other adjacent aquifers through geological structures (such as collapse anomalies), this may pose an additional risk of increased water inflows (Figure 13-2). Collapse anomalies are the post-depositional geological structures, which are the products of complex geological, hydrogeological and hydrogeochemical processes. The processes include fracturing, fluid movements, rock dissolution, and rock failure. The structures are high risk features for mine excavation as they may connect aquifers and can act as a conduit to increase inflows into a mine in a short period of time. 3D seismic technology mapped the size and geometrical extent of these structures (Sections 6.4 and 7.1.4). The mitigation of potential hydraulic connection with the overlying aquifers is discussed in Section 13.2.1.

The hydrogeology of the Dawson Bay Formation was characterized by utilizing the available site-specific data and conceptualized to understand the site scale groundwater flow system. A groundwater model was developed using commercially available industry standard groundwater modelling software FEFLOW. The model was constructed based on the site scale hydrostratigraphical units and geological structures (such as collapse anomalies). Due to the variability of available site-specific hydraulic parameter values of the Dawson Bay Formation, the model considered Min, Mid and Max inflow cases for Base Case inflow scenario (i.e., inflow from the Dawson Bay Formation only) and Special Case inflow scenario (when mine excavation intersects collapse anomalies). The model was built to inform potential inflow risk and provide critical information for decision making in support of mine design and mine dewatering.

In the Qualified Person's opinion, the level of technical details in the study of the Dawson Bay Formation and collapse anomalies is adequate for the assessment of their risks to potential mine inundation at the time of preparation of this report. The model needs to be updated to refine the current prediction of inflows when additional site specific data for the Dawson Bay Formation are

available. The calibration and uncertainty analysis of the model will also be required as mine operation begins and advances.

### 13.3 Production Rates and Mine Life

The estimated annual tonnage and grade profile is shown in Figure 13-4, with values shown in Table 13-1. The production profile is aggregated from the mine schedule which is planned on a monthly basis for the first 10 years, and annually thereafter through to end of mine life. The active mining area progression by period map can be seen in Figure 13-5. Economic testing is performed using the expected production rate and run of mine grade.

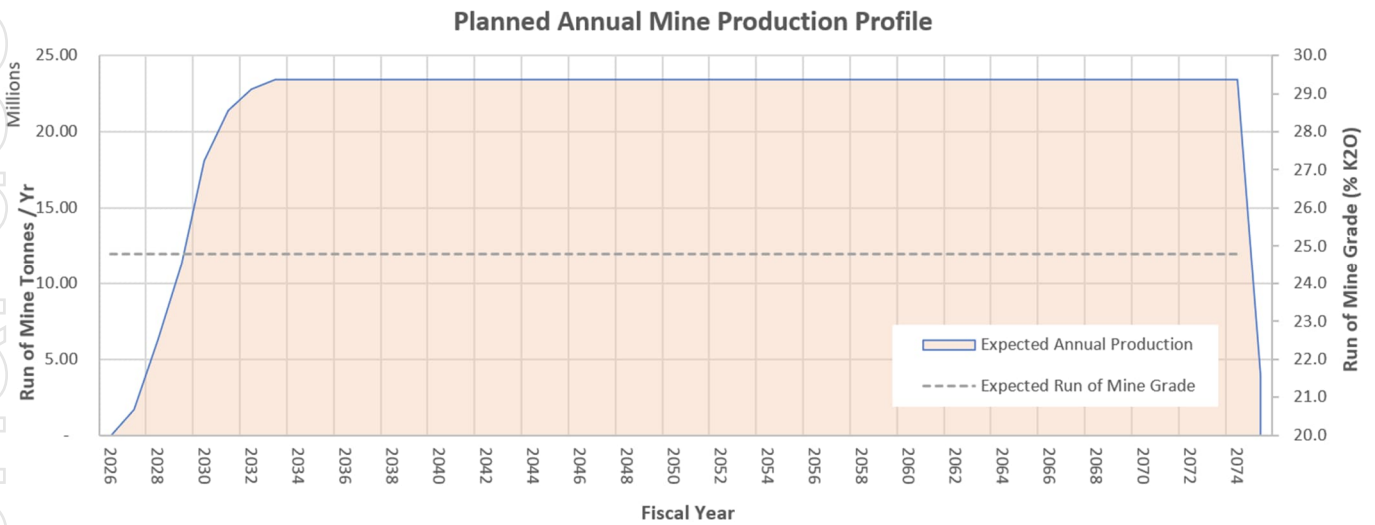

Figure 13-4: Jansen Estimated Production Profile

Table 13-1: Estimated Run of Mine Production (by financial year 1 July – 30 June, based on FY24 LoA)

	Fiscal Year Ending (1 July – 30 June)									
	2027	2028	2029	2030	2031	2032	2033	2034	2035	2036
Expected Tonnes (million)	1.7	6.3	11.2	18.1	21.4	22.8	23.4	23.4	23.4	23.4
Expected Grade (%K <sub>2</sub> O)	24.8	24.8	24.8	24.8	24.8	24.8	24.8	24.8	24.8	24.8

	Per Fiscal Year in Period (1 July – 30 June)				
	2037-2046	2047-2056	2057-2066	2067-2076	2077+
Expected Tonnes (million)	23.4	23.4	23.4	19.2	-
Expected Grade (%K <sub>2</sub> O)	24.8	24.8	24.8	24.8	-

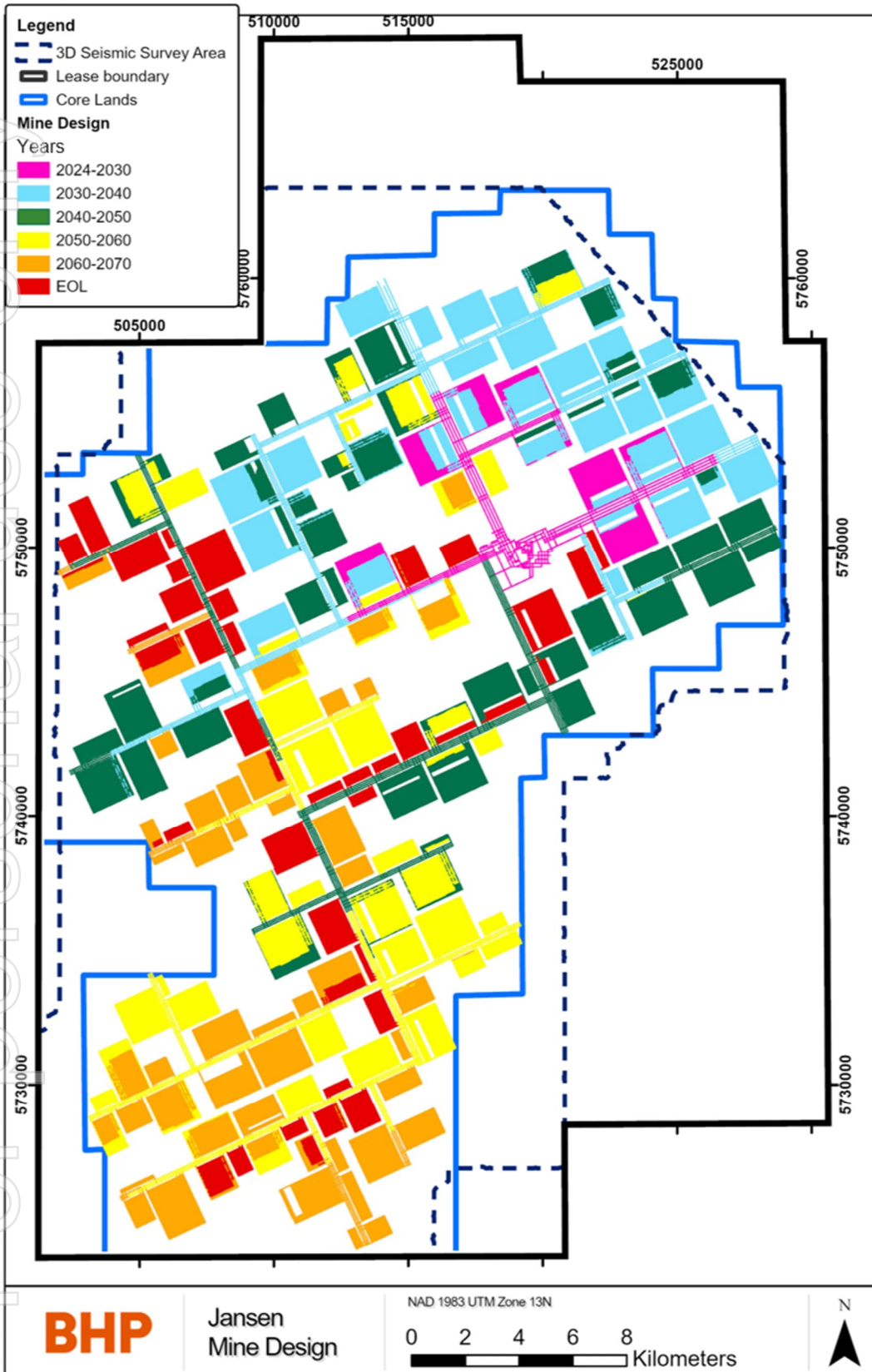

Figure 13-5: Active mining area progression

### 13.4 Mining Unit Dimensions, Mining Dilution and Recovery Factors

The production mining rooms are excavated in two passes, yielding a 12 metre wide opening of varying length. Production panel pillar widths vary with deposit depth between 17 metres and 15

metres. There is no minimum room design length, rather minimum pillar dimensions. In general terms the mine design strives for the longest panel room length, up to a maximum of 1,800 metres. The mine plan strives to assign mining rooms less than 1,000 metres in length to be excavated by a drum miner with batch haulage.

Development mining rooms are subject to the same minimum room sizes, although are excavated larger given the required useful life of the development entry is longer than a production mining room.

Mining height is variable between 3.7 metres and 4.4 metres. A histogram of planned room excavation heights can be found in Figure 13-6. Except for the shaft pillar area, all excavations are expected to occur in the LPL. Each mine design shape undergoes an evaluation of excavation heights to determine the highest ore grade. Determining the planned excavation height is an iteration which first considers the grade of the minimum mining height and the thickness of the overlying dilution material, then compares the grade against a mining height that includes an additional resource model ply. Resource block model ply thicknesses are illustrated in Figure 11-1.

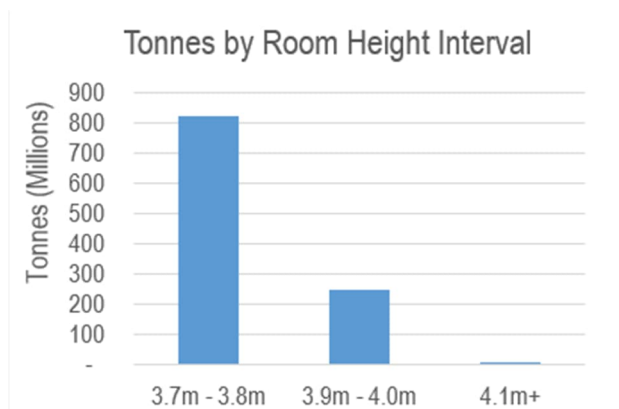

**Figure 13-6: Histogram of mining room design heights**

Mining dilution is captured in the mine plan through the planned overcut of the 406 clay seam and, where required, cutting the overlying halite unit to achieve stable roof conditions. The overlying roof dilution is primarily salt and has a fixed grade of 3 %  $K_2O$  applied. The primary driver for excavating roof dilution is the depth and type of the shadow band (SB). The SB has been interpreted and modelled as a continuous zone of clay bands with categories of alteration. The first category of shadow band are recognised as discrete mud parting planes with varying thickness. The remaining SB do not form a distinct defined parting plane. The SB that form discrete parting planes within the roof beam thickness thresholds discussed in Section 12.1, are planned for excavation. The regional geological deposition is discussed in Section 6.1.

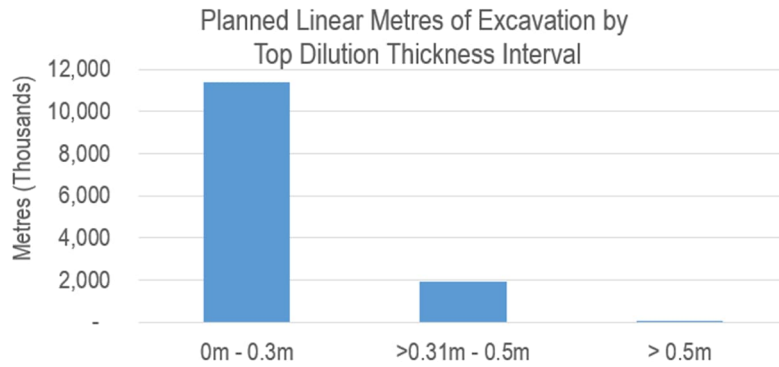

**Figure 13-7: Histogram of planned linear metres to be excavated by top dilution thickness interval**

It is the opinion of the Qualified Person that the mining dilution has been reasonably reflected in the mine plan, and therefore the economic evaluation, through the use of a planned global overcut of 10 centimetres on the targeted roof strata, and the use of roof beam thickness thresholds triggered by the capability of the ground support and a modelled shadow band interpretation. Of noteworthy comparison is the positive economic value shown in the Min range case, Table 12-6, despite an aggressive overcut of 20 centimetres in all instances, and complete removal of all shadow band types for the entirety of the mine life.

As no production has occurred to date, no reconciliation data is available. The mining recovery is estimated to be 100 per cent recoverable. Ore losses from transport between mining face and the ore processing plant have not been considered. The reported mineral reserve grade is considered fully diluted.

### 13.5 Overburden Stripping, Underground Development and Backfilling

The use of backfill at Jansen is not currently planned. Fine and course tailings will be placed in the tailings management area.

Refer to Figure 13-5 for the active mining area progression. Mine development entries will be excavated in the LPL ore zone.

Backfill in the sense of providing geotechnical support is not currently planned at Jansen. However, periodic storage of material will occur due to rehabilitation work that will take place over time. The destination of this material may either be stored in stable old entries or loaded onto the conveyance system to the mill.

### 13.6 Equipment and personnel

According to the mine plan, underground construction and mining activities of the Jansen mine will be supported by a fleet of mobile equipment (Table 13-2). The listed equipment is to be purchased and commissioned through the construction and production ramp up period. The dimensions of the mine design reflects the use of this equipment. Asset management at Jansen is based on fit-for-purpose life-cycle cost analysis and maintenance planning is in alignment to the life of mine plan. The mine plan considers the frequency and duration of maintenance activities in the schedule.

For personal use only



The underground mobile equipment fleet is expected to include all equipment required for:

- Early shaft pillar development and mine construction
- Shaft and mine services, including conveyance system construction and upkeep
- Production panel support, including development of cross-cuts and stubs
- Mains development support
- Ground support and rehabilitation
- Emergency response
- Personnel transport

For personal use only

**Table 13-2: Jansen life of mine mobile equipment list**

Group	Equipment	Quantity
Ground Control	Roof Bolter	17
	Scaler	8
Continuous Drum Miner and Support Fleet	Battery Ore Haulers	23
	Drum Miner	7
	Feeder Breaker	10
Mining System	MF460	8
	PO140 EBS	7
LHD Fleet	LHD – 3 to 18 tonne	25
Transport Fleet	Crew Carrier & Transport- Mine Rescue	4
	Fire Truck – Mine Rescue	1
	Personnel Carrier – Service Truck	27
	Personnel Carrier	66
	Cassette Carrier Truck	14
Multi-Purpose Chassis Fleet	Diesel Fuel Cassette	4
	Lube Cassette	4
	Mechanical Heavy Duty Service Cassette	6
	Scissor Deck Truck	4
	Utility Cassette	4
	Water Collection – Vacuum Cassette	2
	Water Cassette	2
Specialized Fleet	Mobile Crane / Forklift	7
	Mobile Belt Line Clean-up conveyor	2
	Motor Grader	1
	Skid steer or Compact track loader	3
	Tractor	2
	Tractor – UG Large	1
	Diesel Generator	3
Telescopic elevated work platform	2	
Flexible Mobile Conveyor	Flexible Mobile Conveyor	1
Telehandlers	Telehandler – 2.5 to 20 tonne	25
<b>Total</b>		310

The total headcount for the Jansen operation, under the current mine planning assumptions, is expected to be 896 total BHP employees (Table 13-3). Under normal operating conditions Jansen mine will operate 24 hours per day, 7 days per week. The roster options will vary by role and by location. The headcount at Jansen is expected to remain reasonably constant for the life of mine. The headcount includes:

- all operations direct BHP Canada employees working in traditional operational work execution, supervisory and planning functions;

- All Jansen-related business functional support employees including Human Resources, Health, Safety and Environment, Indirect Technology, Finance, Supply, Corporate Affairs, Legal, Marketing, Planning & Technical, and the Asset President;

The headcount excludes the following roles, with the associated costs captured in the Intragroup Service Charges (IGSC):

- All Global functions indirectly supporting Potash, including Strategy and Development, port and rail operations.

**Table 13-3: Jansen Full Time Equivalent personnel at steady state**

	<b>Total FTE</b>
Leadership & Administration	5
Underground & Surface Production	296
Port & Rail	7
Underground & Surface Maintenance	374
Integrated Operations Management	110
Operations Technology & Asset Improvement	78
Engineering	26
<b>TOTAL</b>	<b>896</b>

### 13.7 Final Mine Outline

The LoA mine design is shown in Figure 13-8.

For personal use only

For personal use only

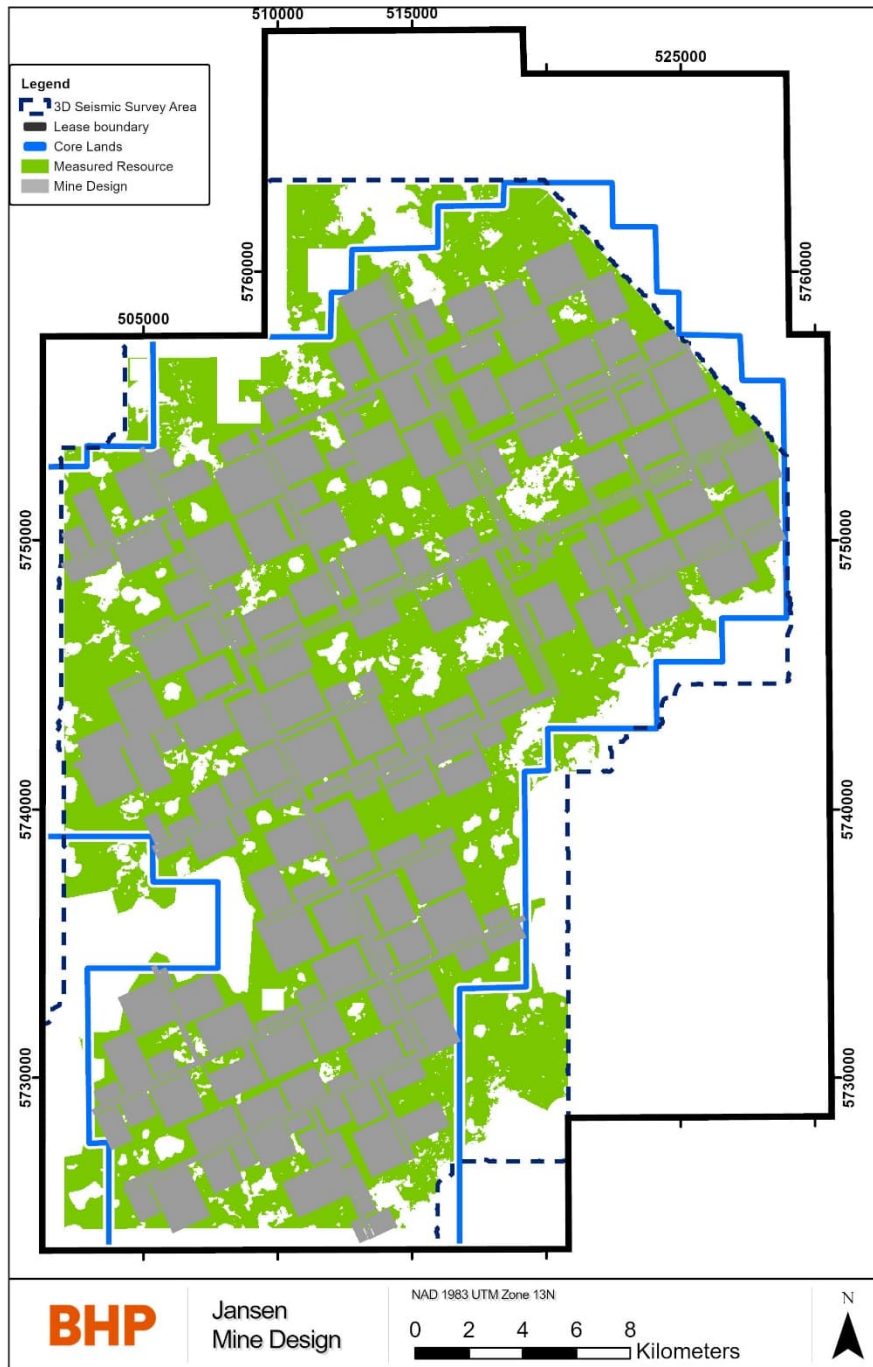

Figure 13-8: Jansen mine design.

## 14 Processing and Recovery Methods

Conveyors will transport raw ore (approximately 40 % KCl salt, 53 % NaCl salt, and 7 % water insoluble) from the service and production shafts to one of two processing plants or the common raw ore storage building. The raw ore enters the processing facilities and is then crushed and screened before being fed to the wet scrubbing circuit, where it will be mixed with brine in the pulping tank. Water insoluble materials are removed from the salts with hydrocyclones, then the salts are pumped to a flotation circuit to form a potash concentrate by separating the potash salts (KCl) from the non-potash salts (NaCl). The concentrate is transferred to centrifuges to remove the brine, forming a concentrate cake. The concentrate cake is dried in a fluid bed dryer before final material screening and sizing. The processing circuit will produce two types of saleable potash; a standard red product and compacted red granular product. The potash products are then stored in a common product storage facility before being loaded into railcars for transport.

The Jansen processing design is conceptually based on selecting equipment of the largest capacity available to achieve the process requirements and installing only minimal redundancy required for optimizing operating reliability. Both processing facilities are designed for a 1,483 tph feed rate, with a minimum 15 per cent design factor on all equipment to handle process variables.

Equipment known to exhibit high reliability based on reliability modelling and industry experience, such as belt conveyors, were selected to be single stream with no redundancy. When multiple pieces of equipment were selected for an individual unit operation (as a result of limited capacity of commercially available equipment or for reasons of reliability), an even number of equipment typically was preferable. This was to enable efficient flow splits between individual streams feeding or exiting the equipment, and keep the building heights and material lift heights to a minimum.

Use of multiple pieces of equipment allows continuation of operation during periods of equipment downtime, albeit at a lower production rate while equipment repair or maintenance is performed. Use of multiple pieces of equipment, where appropriate, also allows predictive and preventative maintenance on equipment as appropriate.

As a result of this philosophy, overall plant uptime will be maximized due to the parallel processing plants, parallel circuits available within each plant, and reduction of single points of failure. An exception to this is equipment that typically exhibits high reliability levels, which would be cost prohibitive to duplicate (e.g. conveyors immediately upstream or downstream of the mill), combined with an optimized maintenance and operating strategy.

The raw ore handling and ore storage portion of the surface processing facilities is designed to be operated by feeding the primary crushing equipment directly from the shafts using belt conveyors. Ore delivered from the hoist in excess of mill feed requirements is diverted, using a splitter gate, to the raw ore storage building to build an inventory of raw ore. Raw ore in the 40,000 tonne storage building is reclaimed as required during hoist down periods. In this way, the raw ore bucket wheel reclaimer is needed to operate less than one quarter of the scheduled mill operating time, reducing operating and maintenance costs as well as allowing raw ore reclaimer servicing as required.

The mill processing systems are largely duplicated, and the designs are based on a high level of automation for process control using on-line measurement, including weigh scales to monitor dry

material flow monitoring, flowmeters for liquid flow monitoring, and potash grade analyzers for reagent control and performance monitoring. All automation signals are monitored and controlled from a remote central control room.

Specific pumps and crushers are installed with variable speed drives for control and to allow metallurgical process variability as required. Various types of crushers are used throughout the processing facilities. Crusher types were individually selected based on the optimal type to serve that particular duty.

Scrubbing and desliming of the ore uses mechanical scrubbing and cyclone desliming, which is typical in the potash industry. Separate coarse and fine flotation circuits allow enhanced recovery of potash due to the modern and proven flotation technologies targeting recovery of specific potash particle size ranges. Separation of ore into coarse and fine streams is accomplished using hydraulic classifiers that provide a separation of coarse and fine particle sizes. Flotation uses column flotation cells that are simple and highly effective in terms of recovery and operating costs.

The tailings process areas are independent and are primarily single circuits due to the high reliability of the equipment selected. Coarse salt tailings circuits are designed with two operating pumps and pipelines as well as one spare pump and pipeline. This configuration allows high mill operating time even when a tailings line may be inoperable due to plugging or pump failure.

Separate scrubbing and flotation brine systems are provided to prevent ore borne contaminants from reaching the flotation circuits and adversely affecting recovery. These systems also maintain reagent-free brine for scrubbing and desliming circuits to maintain process efficiencies in these circuits.

Both processing plants have parallel process circuits in drying and product screening which allow control of the equipment at lower operating rates and to maximize plant operating time. Debrining prior to drying uses latest technology centrifuges that are capable of producing low moisture levels in the dryer feed. Product drying is achieved through conventional horizontal fluid bed dryers.

Dried discharge is screened, and product that meets standard product size requirements is cooled and sent to product storage. Product, that does not conform to standard sizing specifications, is processed in compaction circuits, by 14 installed compactors, to produce granular product, which is subsequently glazed and screened, then dispatched directly to a common 200,000 tonne product storage.

Product reclaim and loading of railcars comprises reclaiming, screening, treating with anti-cake and dedusting reagents, and loading railcars in a unit train of up to 177 railcars within a 12-hour time period. As a result of this loading rate requirement, loading is continuous, using automated product reclaiming and BHP Canada railcars.

The BHP Canada philosophy governing the process design was for a “fit-for-purpose” and expandable facility. That is, a facility that maximizes the project value with acceptable capital costs, while providing a productive, efficient, and safe operating environment for personnel. The Jansen processing facility was designed to use state-of-the-art, proven process control technology to ensure high yields, low cost of production with remote operation capability, and reduction in the amount of field operator support.

## 14.1 Process Plant

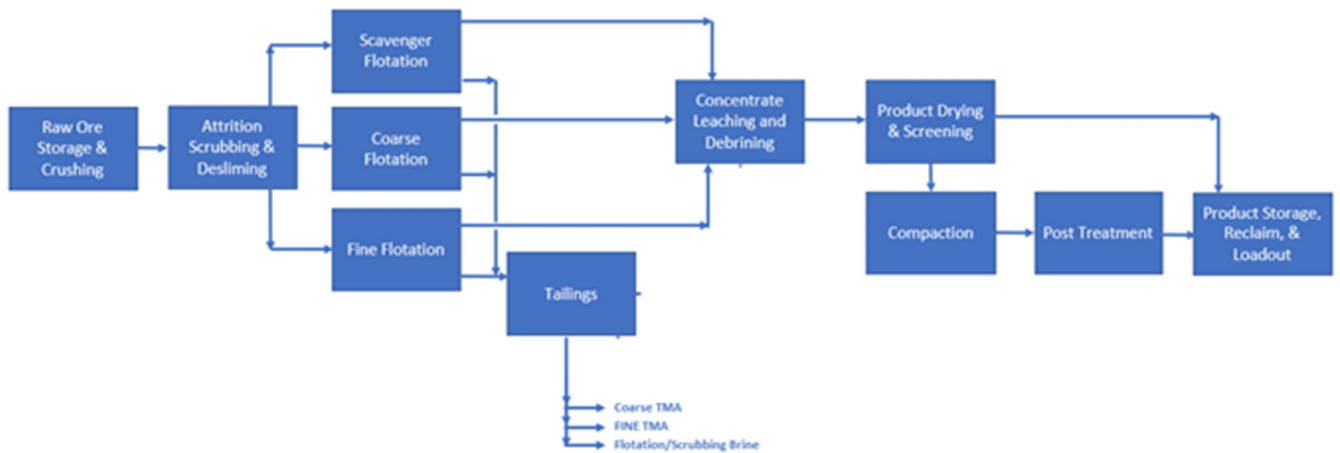

**Figure 14-1: Jansen processing sheet flow**

Raw ore is received from the mine through the service and production shafts skip bins. A moving hole feeder is used to draw raw ore from the bins onto the shafts raw ore belt conveyors. A belt conveyor scale and tramp metal removal magnet are provided for each shaft material handling system. Material from the shafts then report to the storage building or one of the two crushing plants.

The raw ore handling and crushing circuits are to maintain a constant flow of ore to the mills for processing. The conveying and splitting functions source ore in a variety of feed situations and the crushing stages ensure the material is small enough to feed the attrition scrubbers and be hydraulically pumped to the next process steps.

Attrition scrubbing and desliming circuits prepare the ore for downstream flotation separation stages. This involves wet crushing and scrubbing of the ore to liberate insoluble materials, in conjunction with size separation equipment that prepares three size fractions. Coarse, fines, and slimes streams are then sent to three different sets of downstream equipment, chosen for best performance within the selected size range.

The purpose of the coarse flotation and regrind circuit is to recover coarse sylvite minerals using conventional potash flotation technologies. Concentrates generated within this circuit are generally near grade and require minimal leaching. The waste materials are relatively clean halite with some unliberated sylvite.

The fines flotation circuit recovers fine highly liberated sylvite minerals, using conventional flotation technologies. Concentrates generated within this section are generally high grade and require minimal leaching. The particle sizes are relatively fine, so most conventional hard rock flotation equipment is effective. Pneumatic columns are the chosen technology since they achieve high grades and recoveries in potash applications. Waste materials are relatively clean halite with some minimal sylvite losses.

The scavenger cyclone and flotation circuit is used to recover very fine highly liberated sylvite minerals, using conventional flotation technologies. Concentrates generated within this section are generally lower grade than the other circuits due to the higher difficulty in physical separation of very fine materials. The fine particle sizes require higher energy flotation equipment to be

For personal use only

recovery effective. Self-aspirating pneumatic cells are the chosen technology since they achieve acceptable grades and recoveries in potash applications.

Leaching and debrining circuit provide secondary control for concentrate grade control, flotation brine recovery, and preparation of the solids for the drying and screening circuit. The large volume leaching tanks serve a secondary function by acting as buffers between the wet and dry circuits. The individual line tank can buffer 30 minutes of production in the event of a downstream interruption.

The primary purpose of the product drying and screening circuit is to remove residual moisture, heat the product sufficiently to remove residual reagents, and prepare the material for compaction. The production dryer circuit serves a secondary function to produce the KCl-rich brine needed for grade control using its dryer scrubbers. The screening circuit follows the dryers. Standard grade final product goes directly to storage, while the rest of the material flows to the compaction circuit.

Compaction and post treatment circuits ensure the Jansen products meet quality standards and prepares the product for storage prior to shipment. While standard-sized material meets national and international accepted standards, finer and coarser materials produced in the wet mill do not. The compaction process uses high pressures and temperatures to convert these materials into a marketable size fraction. Post-treatment circuits are physically located after compaction and treat both standard and granular products.

For standard production, the standard product (mid-size particles) from the product screens not sent to compaction feed is conveyed to two parallel product coolers. The material is cooled below 80°C using a glycol loop that is integrated into the plant heat recovery system. Cooled product is then weighed as it continues by conveyor to product storage.

For granular production, a multi-step process is employed to increase the product durability and minimize storage lump generation. This consists of a surface hardness and rounding step, a cooling step and then a final size quality circuit. Product from the secondary compaction screening circuit is moistened in the glazing dryer conditioning drum using carefully controlled amounts of process water. Sufficient water, approximately 1 per cent to 2 per cent by mass, is added to dissolve and soften only the surface KCl on each particle. The tumbling action and abrasion in the conditioning drums rounds off the sharp edges of the moistened potash granules. This product is fed into the glazing fluid bed dryer/coolers, which act as an evaporative cooler. When the surface water on the granules evaporates, a harder coating is formed on the surface of each particle, which increases its resistance to degradation during subsequent handling and transport. In addition, water evaporation in the glazing dryer cools the granular product to the target 80°C before it is discharged into the glazing screen feed bucket elevators. Exhaust gases from the compaction glazing dryers and dust collected within the compaction circuits are processed in baghouses.

The primary function of the product storage, reclaim, and loadout circuits is to collect enough product to fill a shipment order and load a full 177-car unit train in under 12 hours with treated quality product. The product storage building holds 200,000 tonnes of combined standard and granular product and uses a portal scraper reclaimer to provide a steady high flow rate. Product loadout screening removes lumps in all products and any fines that may have accumulated in the granular product. The last step is the weigh bin system that loads a continuously moving train.



## 14.2 Plant Throughput and Design, Equipment Characteristics and Specifications

The Jansen mining and processing facilities have been designed for continuous 24-hour operation, with scheduled outages to perform inspections and maintenance. Production operations and maintenance will consist of two 12-hour daily shifts covering 7 days per week. Since the JS1 and JS2 mills are essentially split into two parallel processing trains, maintenance will typically occur in one mill and on one train at a time, using additional contract maintenance workers as necessary to perform the scheduled maintenance and inspection tasks. The entire processing facilities will also be shut down less frequently to provide for maintenance on equipment serving both processing trains.

The Jansen mill operating schedule is intended to closely align with the mine's planned operating schedule. Major raw ore storage facilities on site include:

- Underground ore storage capacity within the shaft pillar consists of three 5,000 tonne bins, a 40,000 tonne remote storage, as well as belt bunkering as the material handling system extends (equivalent to 15 hours of combined hoisting capacity);
- 40,000 tonnes of raw ore storage capacity on the surface to support the two mills, each with a 1,483 tph feed rate (equivalent to 13 hours plant feed).

Underground and surface ore storage enable the mine to stockpile ore to ensure the mill feed remains constant during equipment outages for inspection or maintenance. Surface raw ore storage allows ore processing activities to continue for up to 13 hours at nominal feed rates whenever ore hoisting facilities are unavailable for use or equipment failure occurs upstream from the raw ore storage pile. Regular inspections are expected to include items such as shaft, hoist and rope, and various mine-related maintenance functions that may prevent or reduce the rate of ore delivery to the surface.

The feed throughput range, within which each mill can operate, is 33 per cent to 100 per cent of rated capacity, or 489 tph to 1,483 tph.

In addition, buffers downstream of the mill allow the processing facility to continue operation between train shipments. A 200,000 tonne finished product warehouse will store both standard and granular products and act as a buffer between mine production and the port.

The processing facilities will be controlled and monitored from the Process Control System (PCS). The PCS will provide the control and operator interface for all the areas of the facilities and will be run by a control team in the Integrated Operations Centre (IOC).

The sizing most pieces of process equipment is based on an appropriate design factor on nominal rates. This provides an allowance for cyclical fluctuation in the process. The retention time used for sizing equipment related to scrubbing, storing, mixing, and leaching varies from one piece of equipment to another because the size is based on metallurgical testing recommendations and industry experience.

Key design principles for the Jansen process were that design elements (e.g., equipment, instruments) will be standardized and rationalized to the extent practicable and the use of industry-proven processes and equipment is maximized.

The level of automation will be high and will include automation of normal process control functions, start-up, and shutdown activities. The PCS will be a fully integrated system using a

common control platform across Mining, Process and Non Process Infrastructure. The PCS will provide human-machine interface (HMI), process control, monitoring, alarming, and data archiving for all operating areas of Jansen site. The PCS will also interact with the Advanced Process Control (APC) system benefiting from advanced algorithms that will assist determining the most efficient operating set points to increase throughput, reduce energy cost and reduce reagents consumption.

The process will be controlled from an IOC located off-site in Saskatoon and will be completely centralized with the ability for controlling mine, plant, rail yard, and port control stations. This arrangement provides operators with greater levels of live operating data across the potash operation and fosters collaboration. Trend identification, troubleshooting, and the prevention of potential operating losses can be anticipated and resolved more efficiently compared to traditional decentralized control systems.

### 14.3 Requirements for Energy, Water, Process Materials, and Personnel

#### Raw water

Water is used at the Jansen site for both process and non-process activities. Process water is used for: (among other things)

- Wet scrubbers
- Concentrate leaching
- Process reagent mixing
- Pump gland water and instrumentation flush
- Product centrifuges
- Flotation columns and cells
- Glazing dryer conditioning drum
- Salt tailings flushing

Ore processing activities will use 0.15 m<sup>3</sup> water per tonne of product produced or ~41 per cent of all water consumed on site. Non-process uses (i.e., non-routine water, utilities, and potable water) account for the remaining 59 per cent of water consumption on site, which is equivalent to 0.22 m<sup>3</sup>/t of product. A considerable amount of this water will be used by maintenance, because all equipment must be washed down before being serviced. Spill clean-up and line flushing are other services that will contribute to this amount.

#### Energy

The incoming gas supply battery limit for natural gas is located on the southwest side of the process plant sites, outside the plants, to allow free access by SaskEnergy and TransGas.

An existing metering building is currently constructed and operational at site for gas supply to on-site accommodation, sewage treatment plant, and concrete batch plant. A natural gas connection to the site will be provided for gas supply to the processing plants (i.e., gas metering and pressure reducing station). The natural gas pipeline follows a pre-determined utility corridor to the natural

gas metering station. The interface point between the off-site supply and on-site distribution system is at the flange connection just downstream of the pressure reducing station.

A total of two natural gas supply pipelines will be located downstream of the natural gas metering station. One pipeline feeds the process plants and ancillary buildings. The other feeds on-site accommodation and the concrete batch plant.

Throughout the plant site, the buried natural gas distribution system will be sized to support future production capacity increases. It will consist of medium density polyethylene pipelines. Major line isolation valves will be installed at specific locations to isolate a branch of the gas network. These line isolation valves will be located above ground. Furthermore, each building connection will include a dedicated isolation valve.

Power is supplied by SaskPower's 230 kV overhead lines. The main site 230/35 kV substation and 35, 5, and 1 kV distribution systems are sized to support future expansions. The underground is fed by two 35 kV shaft feeders from the service shaft. In the event of a utility power off the essential loads will be fed from the site's generation facility.

The Jansen natural gas usage is estimated to be 3,231,461 GJ/year. Electricity is estimated to be 1,119,855 MWh/year, and diesel is estimated to be 2,295,564 L/year.

#### **Process Materials**

A variety of reagents are required for operating the flotation circuits, thickener operation, and treating the product for shipping. Process reagents include flotation amine, acid, flotation oil, frother, depressant, and flocculent. Product anti-cake amine combined with dedusting oil is applied in product loadout. These reagents are available in Saskatchewan and are used in existing potash facilities. Sufficient work has been completed to ensure supply and availability to the BHP Canada Jansen site.

#### **Personnel**

See Section 13.6 for Jansen staffing information. See Section 13.6 for Jansen staffing information.

### **14.4 Novel Processing Methods**

The Jansen processing facility is expected to use proven process control technology designed to support high yields, low cost of production with remote operation capability, and reduction in the amount of field operator support. In addition to common process control technology, Jansen is expected to employ additional digital technology to improve recovery, operability, and availability using systems such as advanced process control, digital twin for raw ore pile management, and use of equipment health monitoring for predictive maintenance. No new processing methodologies or commercially unproven methods are expected to be incorporated into the Jansen process plant design.

## 15 Infrastructure

Jansen is currently in construction phase and has completed a significant amount of development in the past several years. The capital invested to date includes construction of the shafts and associated infrastructure, surface building foundation preparation and construction, as well as engineering and procurement activities, and preparation works related to underground infrastructure.

A substantial portion of the site grading, drainage and road network is in place that allows for access to all areas of the site and facilitates water management during spring melt, rain events and ongoing construction.

The site is connected to off-site infrastructure including natural gas, permanent electrical power, communication fibre and non-potable water. These utilities are provided by Crown Corporations and contractual agreements have been reached for service provisions as necessary. The local road network has been upgraded to allow for year-round access for primary weight vehicles to support the movement of equipment and materials as necessary during the construction period.

Additionally, there have been several facilities for both permanent operations and temporary construction purposes that have been successfully installed to date including:

- The Discovery Lodge camp (2,600 beds) for housing the construction workforce;
- A modern water treatment plant and raw water well for provision of potable water;
- A sanitary treatment plant for raw sewage;
- A concrete batch plant;
- Temporary offices, locker rooms and lunchrooms for construction team;
- Service and Production headframes;
- Freeze plant to support shaft sinking and lining;
- Temporary warehousing and maintenance buildings;
- Permanent cold storage warehouse;
- Vehicle wash bay;
- Guard houses and site fencing for access control;
- Laydowns for material storage/staging ;
- Storm water ponds and effluent storage facilities;
- Environmental monitoring equipment for ground water, air quality, noise and vibration levels.

In the subsequent years, BHP Canada plans to erect/construct the following:

- Mill buildings
- Raw ore storage
- Conveyor galleries
- Product storage buildings

- Product loadout building
- Tailings Management Area

Once these facilities are complete, the equipment and building services are scheduled to be installed to support commissioning activities leading to a planned first production and ramp up to full production accordingly.

In the Non Process Infrastructure scope space, the remainder of the Tailings Management Area (including disposal wells) are scheduled to be developed, the rail infrastructure and control systems are scheduled to be installed and a number of permanent facilities are scheduled to be constructed. These facilities are expected to include:

- Admin Building with offices, locker rooms, security and training
- Heated warehousing
- Mechanical and mobile equipment repair shops
- Laboratory
- Mill support facility
- Rail support facility
- Modular Data Centre, electrical houses and substations
- Pump houses, environmental data collection units and/or other small buildings

Figure 15-1 below, shows the design layout of the surface infrastructure of the completed Jansen Project buildings and includes the processing and non-processing facilities, tailings management area (not shown) and the mining headframes with their respective shafts below ground.

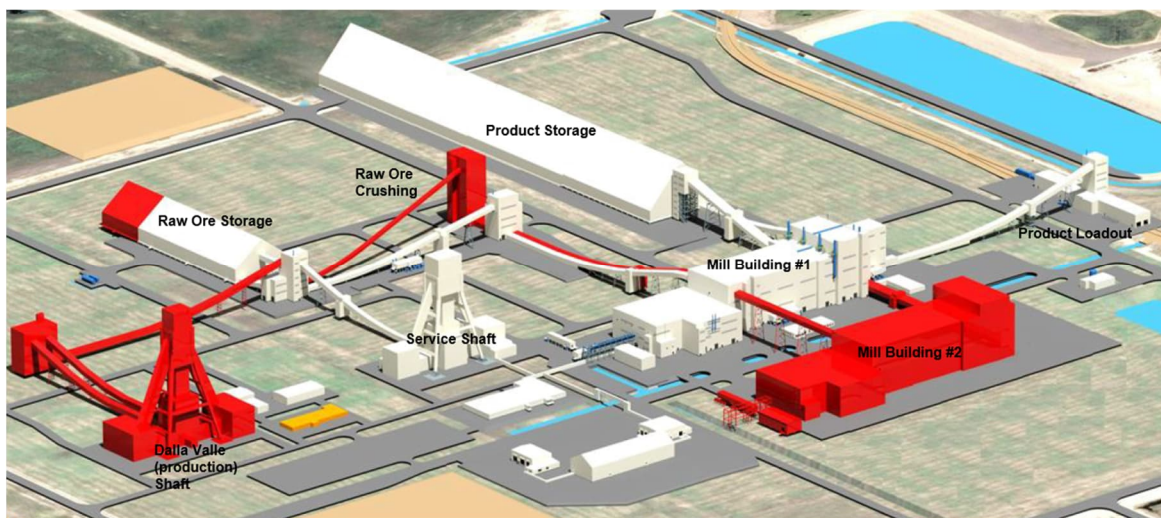
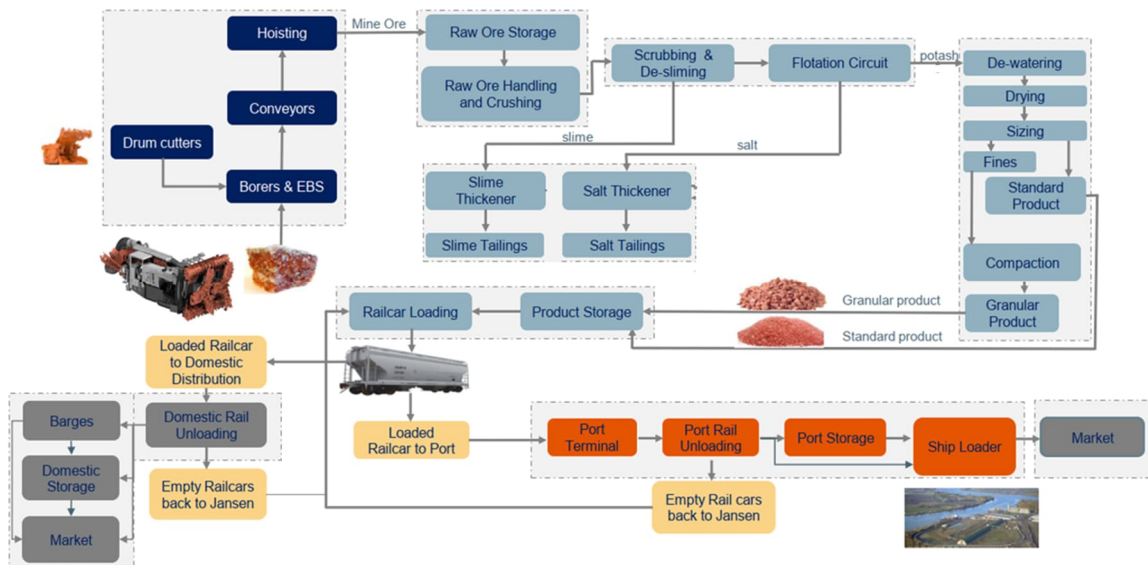

**Figure 15-1: Schematic of Jansen Operations when in production**

The Jansen basic value chain is comprised of a number of major sub-systems and process steps as shown in Figure 15-2.

1. mining, including continuous miners, and conveyors
2. ore hoisting via shaft conveyance
3. mine processing and ore handling plant including crushing and screening

4. mine stacking (stockpiling) into the product types
5. train loading
6. train empty and loaded travel to and from the port facilities
7. port car dumping (train unloading)
8. port direct ship loading (product is taken directly to the vessel, skipping process steps eight to ten)
9. port stacking (stockpiling) into the product types
10. port reclaiming
11. port ship loading



**Figure 15-2: Basic Value Chain**

Underground infrastructure is described in Section 13.

### 15.1 Roads

The road work for the site consists of new roads and upgrading existing roads. All new site roads constructed are expected to be gravel roads with subbase and base course materials. Most of the existing plant site roads have a subbase course and are expected to be upgraded during construction. These existing roads range between 11 metres and 13 metres wide and planned to be topped with a granular base course to a 9.4 metres width. All roads are expected to be crowned with a 3 per cent cross slope to allow storm water drainage.

Many existing roads that form the majority of Jansen site road workings are already in use. Some of these existing roads need to be upgraded with a granular base topping. Some are expected to be demolished because they are located in areas where facilities are to be constructed.

For personal use only

## 15.2 Rail

The on-site railroad, including the Joint Access Spur and Onsite Rail, for the mine site is planned to be constructed during the project execution period. A series of switches (ladder) are located just inside the Jansen property fence line to provide an inbound/outbound yard. This yard terminates at the north end at a double crossover. Beyond the crossover is a loop track through the loadout facility, where empty trains are planned to access the loading area in a clockwise manner.

The off-site railway is planned to connect the on-site railway to both Class I carriers as shown below in Figure 15-3.

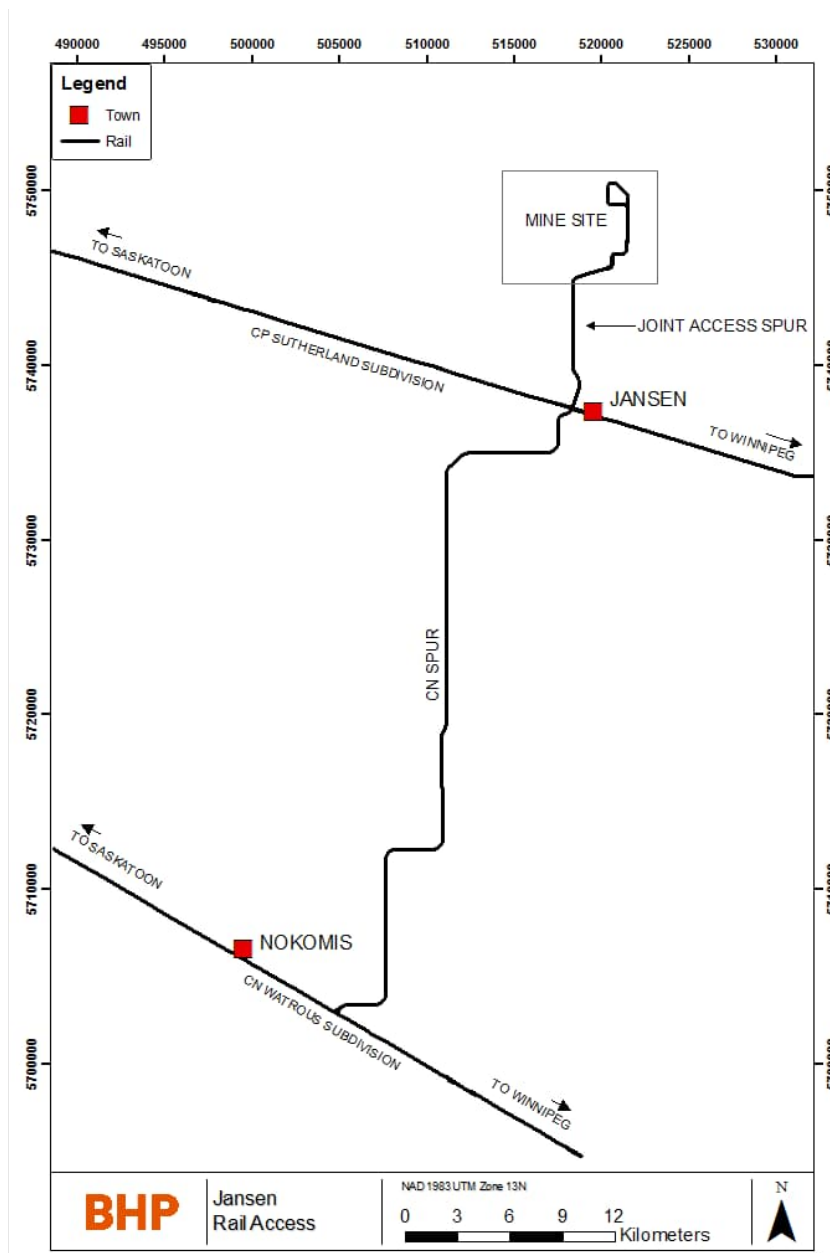

Figure 15-3: Off-site rail connections

### 15.3 Port Facilities

Potash for export is expected to be shipped out of Westshore Terminals Limited Partnership (Westshore). Westshore is an existing coal export terminal operating since 1970 at Roberts Bank, Delta, British Columbia on Vancouver Fraser Port Authority managed federal lands and waters. Currently the terminal handles coal, and with financial support from BHP Canada, Westshore has agreed to convert their facilities from exclusively shipping coal to shipping BHP Canada potash and some third-party coal. All required permits for the facility development have not been issued. BHP Canada currently has a terminal services and development agreement in place with Westshore for this development and shipping services with an initial service term through CY2051. The port facility is sized to handle the total expected product volume from Jansen.

### 15.4 Dams

The perimeter dykes within the Tailings area is expected to be constructed of suitable earthen material with an upstream slope of 2.5H:1V and a downstream slope of 3H:1V. The dyke is anticipated to reach a total length of approximately 20,000 metres and a maximum height of 10 metres. The minimum dyke crest width is 5 metres to accommodate one-way mine traffic. A dyke key is to be constructed at the center of the dyke's base to assist with stability and seepage. Interceptor ditches is expected to be constructed with interior and exterior side slopes of 2.5H:1V and expected to have a minimum bottom width of 2 metres.

To reduce erosion from wave action, rip-rap material is expected to be placed on the interior slopes within the decant pond as well as the coarse and fine tailings areas. Rip-rap is expected to also be placed at locations where continuous concentrated flow is anticipated, such as the outlets of the granular toe drains.

### 15.5 Dumps and Leach Pads

There are no dumps or leach pads required for Jansen mine.

### 15.6 Tailings Disposal

Waste produced from the mill processing is planned to consist of fine tailings (insolubles), coarse salt tailings, and sodium chloride (table salt) brine. The fine tailings are expected to consist of primarily silt and clay-sized particles combined with fine salt crystals. The coarse tailings are expected to be medium to coarse-sized salt crystals. The fine and coarse tailings are expected to be separated in the mill during processing and hydraulically transported (i.e., pumped) to the TMA in brine slurries where they will be deposited in their respective storage areas. The separate fine and coarse tailings areas are expected to be surrounded by perimeter containment dykes. The collective footprint of the TMA is planned to be surrounded by a deep brine seepage interceptor ditch and future slurry wall(s).

Brine storage in the TMA is expected to consist of a brine decant pond within the fine tailings area and a separate tailings-free space within the coarse tailings area. Brine created during operations or generated by salt dissolution during precipitation events is expected to be recycled back to the mill by pumping from a floating barge located in the coarse tailings area. Excess brine is expected to be pumped from the barge to the brine disposal wellfield for injection into the deep Winnipeg-Deadwood Formation. This Formation has historically been used by central Saskatchewan potash



mines for disposal of surplus brine due to its accepting permeability and compatible brackish water chemistry. The number of injection wells is expected to increase over time, as the well field is sized to support the disposal requirements of the mine site.

The on-site water balance is planned to be maintained by using deep formation injection wells to dispose of excess brine. The disposal wells are planned to inject brine created during operations, precipitation events, and closure phase of the project. Brine disposal is expected to be an essential step for reducing the volumes of the coarse and fine tailings piles in accordance with the Jansen Site Closure Plan.

Deep well injection is the regulatory accepted method to dispose of excess brine for all existing potash mines in Saskatchewan. No feasible alternatives to using disposal wells at Jansen are known. The alternatives considered to be unfeasible include evaporation, other desalination methods (which would not allow Jansen to meet its closure objectives), and brine disposal to the environment.

In the Qualified Person's opinion, the central feature of BHP's Jansen potash mine TMA, is the incorporation of measures intended to 1) minimize the footprint required for fine and coarse salt tailings placement, and 2) limit the potential impact of tailings on, and requirement for, groundwater; while working towards sustainable decommissioning.

As part of these measures, it is expected that ongoing refinement of the overall TMA design, including the potential for early inclusion of additional disposal cells, may be required to accommodate changes in the nature, and rate, of fine and coarse tailing deposition, as well as for the associated production, storage, and disposal of brine.

## 15.7 Power, Water and Pipelines

The estimated power consumption is expected to be approximately 1.12M MWh/yr. Power is expected to be supplied by SaskPower using 230 kV overhead lines terminating at the 230 kV main plant substation dead-end structure (the point of common coupling). Main plant electrical services (i.e., 230 kV substation plus 34.5 kV substation and distribution) were sized to support future expansions. The electrical distribution system is expected to be designed for expansion without requiring a significant shutdown of plant equipment.

The Jansen site is located in an area with no access to a major watercourse to support on-site infrastructure. The raw water system consists of the incoming water supply line from SaskWater and groundwater sourced from the existing Raw Water Well 1 (RWW 1). The ultimate capacity of the water supply pipeline is expected to be 7M m<sup>3</sup>/y for the Jansen project.

During construction and operations (all stages), potable water is expected to be supplied to both on-site accommodation (Discovery Lodge) and construction management facilities through a centralized water treatment system located near Discovery Lodge. Potable water is expected to be distributed to the plant site by centrifugal potable water distribution pumps. Three pumps are expected to be provided with two pumps operating and one on standby. Potable water is expected to be distributed by an underground HDPE pipeline network. A single network is expected to be provided for the plant site. The potable water distribution system is expected to ensure a minimum pressure of 415 kPa (60 psi) at the buildings. Connections to future buildings (process plant lines or ancillary buildings) are expected to be installed complete with valves and blind flanges to enable straight tie-ins in future.

Sanitary sewage is expected to be treated by an existing Sewage Treatment Plant (STP) sized to accommodate the anticipated loading from construction activities, including the Discovery Lodge. Sewage is expected to be collected and directed to the STP through a combination of gravity and pressurized systems that collect sewage from both process and non-process buildings. Both the existing and future systems lead to the existing STP. The sanitary sewer lines is expected to have enough capacity to convey the design peak flow as well as infiltration and inflow. The minimum diameter for gravity sanitary lines to be used for single building lateral drains is 150 millimetres. The minimum diameter for gravity sanitary sewer systems is 200 millimetres. All pipes are expected to be polyvinyl chloride (PVC) and are expected to have a minimum slope to achieve self-cleansing velocity.

The incoming gas supply battery limit for natural gas is located on the southwest side of the plant site, outside the main plant, to allow free access by SaskEnergy and TransGas. Throughout the plant site, the buried natural gas distribution system is expected to be sized to support the production capacity up to and including future expansions. It is expected to consist of medium density polyethylene pipelines. Major line isolation valves are expected to be installed at specific locations to isolate a branch of the gas network. These line isolation valves are expected to be located above ground. Furthermore, each building connection is expected to include a dedicated isolation valve.

## 15.8 Underground Infrastructure

### 15.8.1 Mine bulk material handling (BMH) system

The mine conveyor network is designed to transport ore from each mining face to the shaft pillar, where it is transferred to the raw ore storage bin or horizontal remote storage area before being transferred to the surge bin and hoisted to surface for processing. The conveyors are expected to be installed using modularized units, each consisting of a head/drive station, take-up station, belting, and structure. These units are expected to have standard lengths and widths, depending on their duty requirements. Permanent conveyors are rigid frame structures that are suspended from the back (roof) to minimize effects of ground movement. Where the design warrants it and the salt beam in the floor is of suitable thickness some parts of the BMH may be floor mounted. The three main conveyor system configurations are panel, block and mainline conveyors shown in Figure 15-4.

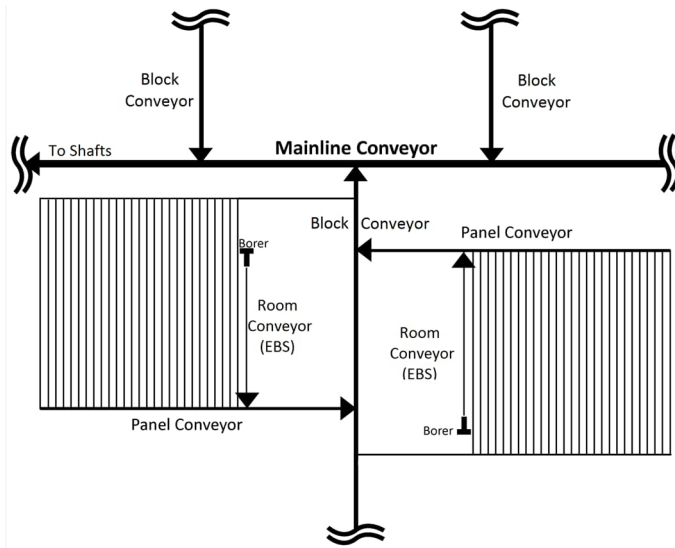

**Figure 15-4: Simplified flow diagram of underground conveyor systems**

### 15.8.2 Underground Electrical Distribution

The Jansen mine is expected to be supplied from the surface 34.5 kV distribution system. The two service shaft feeder circuits are expected to each consist of two 350 MCM cables. They are expected to terminate in a mine substation through which power is expected to be transformed from 34.5 kV down to 13.8 kV for distribution into the mine. Design of the main substation enables complete isolation of any one of the shaft circuits while still maintaining power into the mine. The 13.8 kV distribution voltage is expected to supply all electrical power for the loads within the shaft pillar area as well as out into the mine. A radial distribution is expected to branch out from the main substation with circuits strategically run so that only minimal disruptions are intended to occur with the failure of any one.

Providing a ground path back to earth is a critical safety feature in all electrical distribution systems. Potash rock cannot be used for direct earth grounding. Therefore, the mine distribution system is expected to use three internal bond conductors in each cable. The shaft cables are expected to also have three internal bond conductors working in parallel with separate bonding cables in the shaft. These together are expected to be used to tie the mine bonding network to the surface ground network.

### 15.8.3 Mine ventilation infrastructure

The mine ventilation system is designed to provide adequate airflow to all active areas of the underground mine to ensure the health and safety of workers is maintained throughout development, construction, and steady state production. The ventilation system is expected to control accumulation of heat, gases, dust, and other contaminants within all accessible areas underground by diluting the air to safe concentrations and/or removal of the contaminants.

The ventilation system mechanical components consist of a push-pull arrangement with both surface and underground fans. Under normal operating conditions, the service shaft is the fresh air path and the Production shaft serves as the return air path. Each shaft has a sub collar connection to the ventilation plenum and two surface ventilation fans are expected to be installed, and optionality for a third fan. The intake air is expected to be heated by a natural gas fired heating plant to supply a minimum air temperature of 4°C.

For personal use only

Surface fans are designed to push intake air to just below the shaft collar. The main underground booster fans are designed to draw the intake air down the shaft and distribute it within the shaft pillar and into the mining districts. Each mining district is expected to have a set of booster fans to circulate the air to the working area, with local ventilation fans and ventilation tube to direct air to the working face. Return air is expected to flow from the district conveyors. The main return air underground booster fans are designed to mirror the fresh air arrangement. The return air is expected to exit the mine through the production shaft. The production shaft surface return air fans are expected to be used to bring the return air from just below the shaft collar through to atmosphere.

Controlling risk related to ventilation is composed of several systems and strategies, namely the use of electric vehicles to reduce the exposure to Diesel Particulate Matter, network connect ventilation stations to monitor the flow and air quality at key points in the mine, and proper maintenance of heating and ventilation control systems.

#### 15.8.4 Dewatering

A mine dewatering system is expected to be installed to collect drainage water in the shaft pillar area. Sources of drainage water are expected to include the wash bay water, raw water tank overflow, air condensation from mine ventilation, and shaft drainage from leakage and periodic shaft wash-downs. Jansen intends to limit the use of water underground.

The dewatering system is expected to consist of sumps at the bottom of the service shaft and production shaft as well as in the wash bay. The sumps are expected to be wide enough to allow for slimes removal using an LHD where feasible. Submersible pumps in each of the sumps are expected to pump to a main mud separation storage tank in the mine dewatering station for collection and settling prior to delivery to surface. The mine dewatering station is expected to consist of two dewatering pumps as well as a settling tank. Discharge lines are expected to be installed in each of the shafts with the ability to be drained back into the dewatering tanks when the pumps are not operating.

The planned mine discharge design flow rate up the shafts is 30 L/sec from two 15 L/sec pump skids, with latent pipe capacity in the shaft enabling up to 60 L/sec of extra capacity to be installed as a first response to an inflow event.

#### 15.8.5 Underground maintenance

Areas are expected to be developed in the shaft pillar area to cater for the various underground facilities. All facilities are expected to include suitable power, compressed air, lighting, offices, and other services to complement the planned use of the facility. Adequate parking is expected to be provided for the underground mobile equipment fleet including charging facilities for battery and electric equipment. The shaft pillar facilities are planned to include areas for equipment assembly and rebuild, mobile equipment maintenance shop, electrical shop, wash bay, warehouse and tool crib, fuel and lube storage, refuge chambers, lavatories, raw water storage, and central office space.

## 15.9 Shafts and Hoisting

### 15.9.1 Hoist and headframe

The Jansen Project has two mine shafts, the service shaft and the production shaft. Both shafts have an internal diameter of 7.3 metres and go down to a depth of approximately 1,000 metres. The service and production shafts are required to achieve the expected production volumes.

In the service shaft, the hoist system uses ground mounted Koepe hoists (friction hoists) supplied by ABB and designed by the Hatch Bantrel Joint Venture (HBJV). The hoists are expected to be delivered as per specifications defined by the designer (HBJV). The headframe is a typical A-Frame steel construction. The system comprises a cage and counterweight for personnel and material as well as two skips for ore hauling. The cage and hoist travel through the shaft on a system of rigid steel guides. The system is designed as a Class A guide system to support skips travelling at speeds that could reach 18 m/s. In the opinion of the Qualified Person, the hoisting system is expected to be capable of sustaining the production rate anticipated.

The shaft steel guides are supported by a fully cantilevered Bunton design. The built in flexibility of this design allows to minimize stresses transferred to the shaft liner. This is to promote a longer design life of the liner. The shaft buntons and brackets are built with anticorrosion coatings and will be covered as well by the active cathodic protection system installed for protecting the shaft liner. Coupled to the fully hydrostatic design of the liner, the conditions in the shaft are designed to be dry (meaning no seepage). In the opinion of the Qualified Person, for such conditions, with the corrosion protections put in place, coupled with a good maintenance program, the design life of the shaft steel could be expected to be 50 years.

### 15.9.2 Shaft liner

The Jansen shafts have an internal diameter of 7.3 metres. Both shafts are lined with an integral hydrostatic concrete/steel composite design. From one shaft to the other the geology is similar but shows slight elevation differences. For that reason, although the liner design is the same in both shafts, there are slight variations in the elevations of the liner features from one shaft to the other. The waterproofing is provided by an integral outer welded liner (OWL) from a depth of approximately 835 metres all the way to the surface. The liner base is sealed in the watertight ground formation by a set of redundant water seals at the 835 m depth. The Basis of Design for these liners is for a design life of 70 to 80 years. Considering the performance of other potash mines shafts, coupled with the asset integrity management plan, it is the opinion of the Qualified Person that the design life of these liners could be extended beyond the 70 to 80 years stated in the design basis. By promoting dry shaft conditions, the maintenance requirements should be minimized which in turn supports the higher availability of the hoisting system.

To support better design life of the shaft liner, the service shaft steel guide system was designed with a fully cantilevered configuration. This promotes a reduction of the slamming loads transferred to the liner, hence reducing the cyclic stress levels supported by the liner. In the opinion of the Qualified Person, this design choice will be beneficial to the shaft liner design life as well as the steel design life.

### 15.10 Infrastructure Layout Map

Figure 15-5 below shows the layout of the surface infrastructure for Jansen Project including the processing and non-processing facilities, tailings management area and the mining headframes.

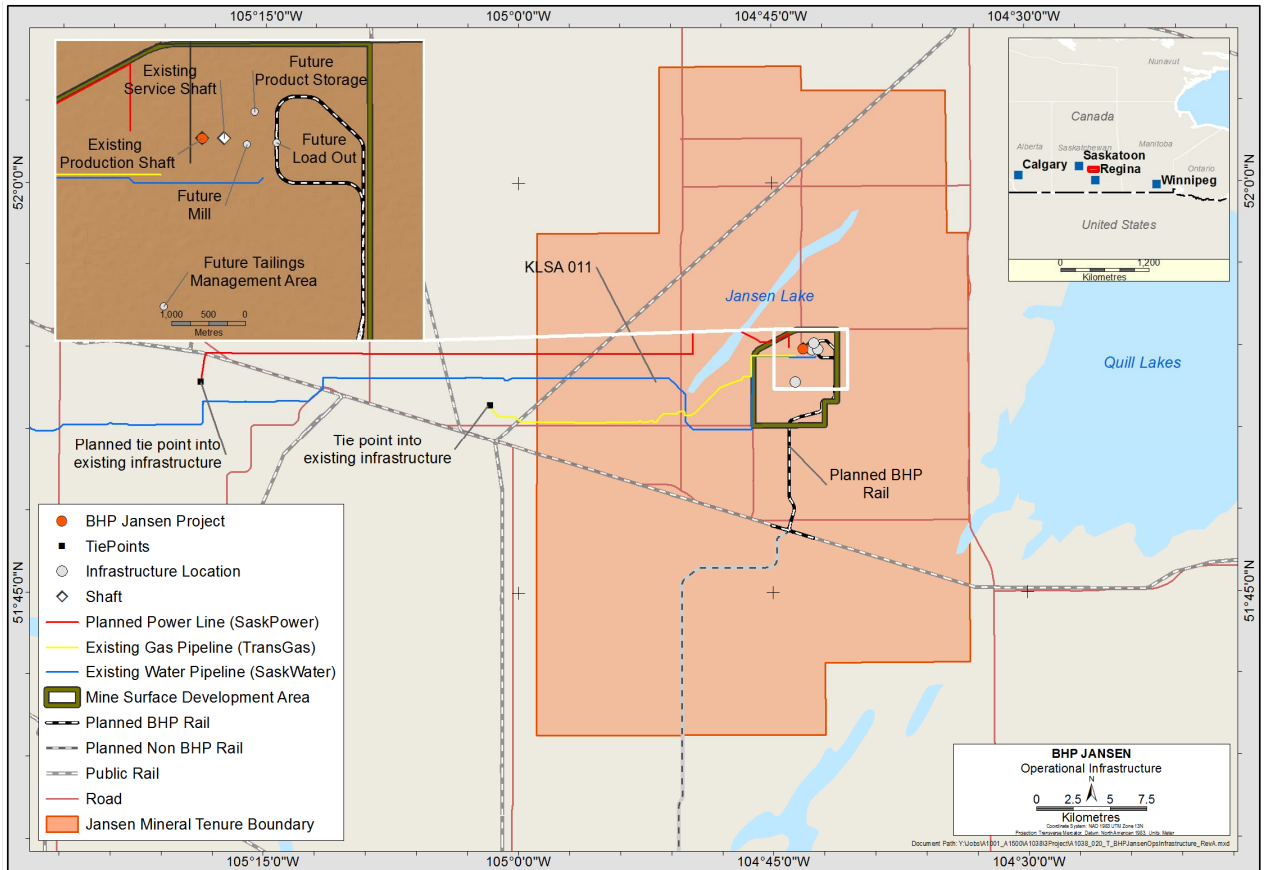

Figure 15-5: Infrastructure Layout Map

For personal use only

## 16 Market Studies

### 16.1 Market Information

Potassium (K) is one of three essential macronutrients that plants need to thrive, along with nitrogen (N) and phosphorus (P). Total potassium uptake of global agriculture is determined by the quantity and mix of crops that is grown.

Potassium nutrient is supplied to crops in three ways:

- through the application of mineral fertilizers
- through organic manures and crop residues
- from the native mineral content of the soil

Native potassium levels vary geographically, and within areas from field to field, and may be depleted over time through intensive cultivation, so farmers commonly provide additional potassium through the application of organic materials (principally, crop residues and animal manures) and/or potash fertilisers to ensure that yields are not limited by inadequate potassium availability.

Potash is the name of a group of potassium compounds. Specifically, it usually refers to potassium chloride (“KCl”), which is by far the most widely used potassium product. Potassium chloride is also known as “MOP”, from the archaic name “muriate of potash”. MOP is consumed principally as fertilizer (92 per cent), although numerous industrial end-uses make up a small minority of the market. As fertilizer, it is most commonly used straight or physically blended with other fertilizers (‘bulk-blends’), but it can also be processed into other forms of potash or Nitrogen-Phosphorous-Potassium (NPK) compound fertilizers.

#### 16.1.1 Product Specifications

Potassium content is commonly measured in units of potassium oxide ( $K_2O$ ), a notional substance, rather than units of K. MOP used in agricultural application is typically ~95 % KCl, which is equivalent to ~60 %  $K_2O$ ; this is in general the threshold required to qualify product in most major agricultural markets.

A large proportion of global market production is chemically/physically similar and produced from similar sylvinitic ore in Canada, Belarus, and Russia, and processed by one of two methods of beneficiation. Most suppliers produce a ‘fine’ or ‘standard’ crystalline powder (primarily used to manufacture compound NPK fertilizer and for direct application by hand) and a larger-sized ‘granular’ grade (used for mechanical application, either straight or bulk-blended with other granular fertilizers), that together comprise the large majority of their sales. These may be red/pink or white (sometimes dyed red) and usually have a guaranteed purity of 60 %  $K_2O$ . Some suppliers also make higher purity grades and/or more sizes that are sold for industrial use, niche agriculture applications or feedstock for derivative fertilizers.

Jansen plans to sell two agricultural potash grades, red standard (~60 %  $K_2O$  equivalent, ~0.5 to 1 millimetres in size) and red granular (~60 %  $K_2O$  equivalent, ~3-4 millimetres in size) potash, to retain simplicity while ensuring sufficient market access.

### 16.1.2 Supply Demand and Pricing

#### Demand

Global demand for potash fertilizers is driven by the need for higher crop production to feed a growing and more affluent, global population. It is also driven by the need to reduce reliance on native soil potassium, which in many places will be unable to support the necessary increase in crop yields. Fundamentally, the relationship between population growth, crop production and potash demand has been extremely reliable and provides a solid basis for projecting future fertiliser needs.

As shown in the two charts below (Figure 16-1), over the last sixty years, crop production has consistently outgrown population while potash has in turn exceeded growth in crop production.

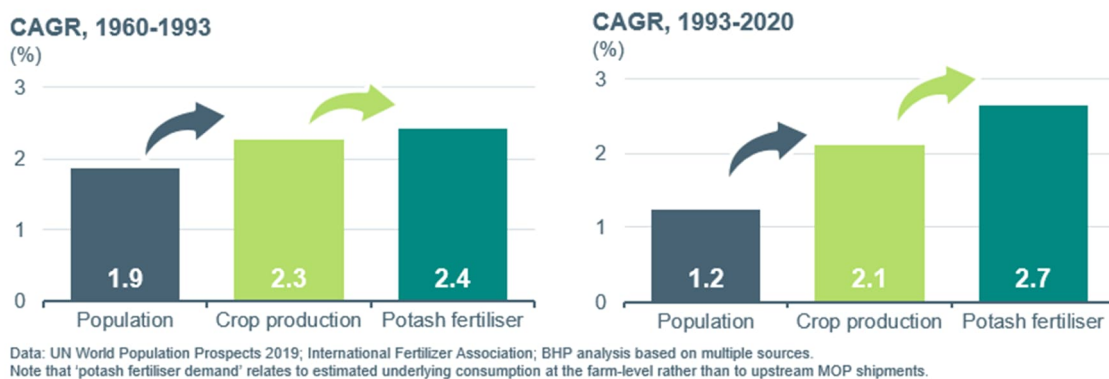

**Figure 16-1: Historical relationship between crop production, population and potash demand**

While the demand trend is reliable over five to 10 year periods, potash demand is at times subject to considerable year-to-year variations due to shifting farm economics, weather, policy and the ability of soils to retain potassium from one season to the next. However, long term demand is underpinned by slow moving, yet very reliable drivers consistent across decadal time spans. This broadly includes the number of mouths to feed, the scale and scope of diets and long run trends in soil fertility and the associated interplay with fertiliser application rates.

Historical growth since 2000 has been 2.7 per cent per annum on average, with the most recent ten-year period coming in around 2.4 per cent. Global potash demand growth over the next decade is estimated in the range of 1-3 per cent.

#### Supply

According to independent market analyst CRU about three-quarters of MOP production comes from underground ores – mainly located in Canada, Russia and Belarus (Figure 16-2). It is simple and established technology, low-cost and energy-efficient. Much of the remainder is extracted from natural brines in China and Dead Sea. Ore is most commonly processed through flotation that yields a product that is pink or red and usually about 95 per cent pure. Jansen is designed to employ the conventional underground mining and flotation route. As of 2023, there are three large-scale solution mines, all of which are located in Canada.

For personal use only



For personal use only

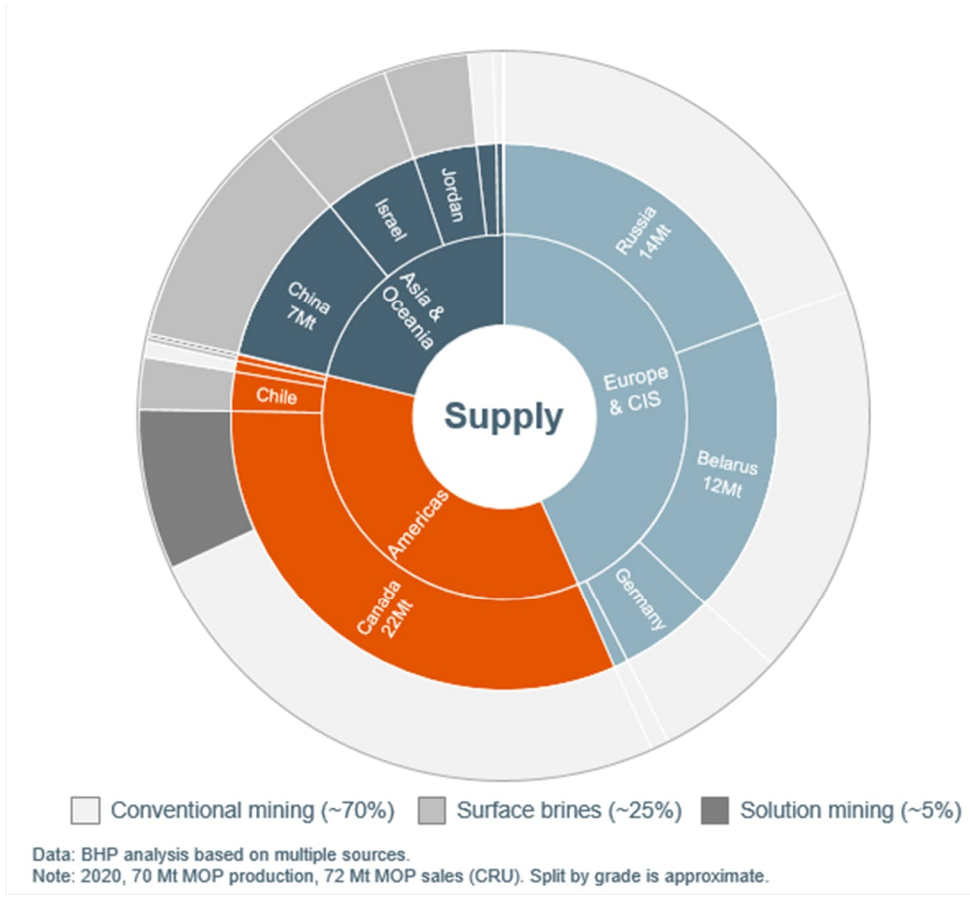

**Figure 16-2: MOP supply by regions (Mt)**

Most potash operations produce between 1 and 4 Mtpa. The mines in Canada mostly date back to a period of rapid development in the 1960s and 1970s, while much of the capacity in Russia and Belarus was built in the Soviet era. The potash industry structure is presently characterized by a small number of large suppliers. In terms of supply concentration, four producers (Nutrien, Mosaic, Uralkali and Belaruskali) accounted for ~65 per cent of global production in 2020. During periods of excess capacity and short term demand volatility, parts of the industry have historically adjusted utilization rates with the objective of “matching supply with demand”. Excess production capacity has been absorbed through curtailed production.

In addition to existing supply capacity, there are ten major MOP mine projects under construction or already ramping-up. Four of these are replacing exhausted reserves and planned to feed existing processing plants. If successfully executed, these projects are expected to add about 10 Mtpa of net incremental supply versus calendar 2020.

**Potash Pricing**

Potash is not an exchange-traded commodity and there is no single benchmark representing global market pricing. Transactions are typically bilateral between seller and buyer. There are specialist publications that journalistically assess transacted prices. Most potash sales are made on a delivered “CFR” basis, like granular MOP CFR Brazil or standard MOP CFR China. Prices are published in ranges to reflect the inherent variation in observed pricing due to various factors.

Published journalistic price assessments do not always neatly reflect the net price the seller receives. To estimate a mine netback from a particular delivered location, a number of factors need to be considered. These could include:

- Regional prices (Brazil CFR, SE Asia CFR and US Free-On-Board “FOB” Midwest) are considered, in addition to annual contract prices in China and India.
- Customary industry discounts and rebates are deducted from the listed price – this information is not publicly available.
- Freight costs are subtracted for CFR (or delivered) sales.
- Port costs and inland freight are subtracted.

### **Pricing assumption for economic analysis**

The potash market has underutilised supply capacity which would need to be absorbed before a structural balance is achieved. The potash price of US\$391/t FOB mine (Saskatoon, Real 2024 basis) is based on a central case for BHP that demand is expected to have “caught-up” by the late 2020s or early 2030s by when new supply is expected to be required.

Before the market reaches a structural balance, we expect prices to cycle at or trend slightly above forward-looking estimates of short run marginal cost (SRMC), which are similar to the average prices seen since 2014. This does not preclude the possibility of price upswings, as witnessed in calendar year 2022. It essentially implies that while excess capacity is present, prices are unlikely to sustain at inducement levels.

Once structural balance is achieved, and with demand expected to continue to increase, new supply would be induced. In a central case for BHP, the estimate of the inducement price for the most likely consistent source of Greenfield supply (identified as a large “bench” of Canadian resource suitable for solution mining), is similar to the average through cycle price realised over the last dozen years. In short, the forward looking long run marginal cost (LRMC) is broadly in line with through-cycle averages, which is considerably above SRMC experience of the last few years.

To estimate this through-cycle average, Nutrien’s published (quarterly) offshore and onshore realised prices during 2008-2023 were considered and with quality (standard/granular) and geographical sales mix adjustments to suit future expected sales from the Jansen operation, as exhibited in our current plans. Nutrien’s realised prices are net of discount/rebates/freight, reported on FOB mine basis. After accounting for above adjustments, the average price is estimated at US\$391/t FOB mine (Saskatoon, Real 2024 basis). For the economics analysis covered in Chapter 19, the FOB mine price is used as defined above. It is noted that the Mineral Reserves are declared as delivered to the process plant. Refer to Figure 16-3.

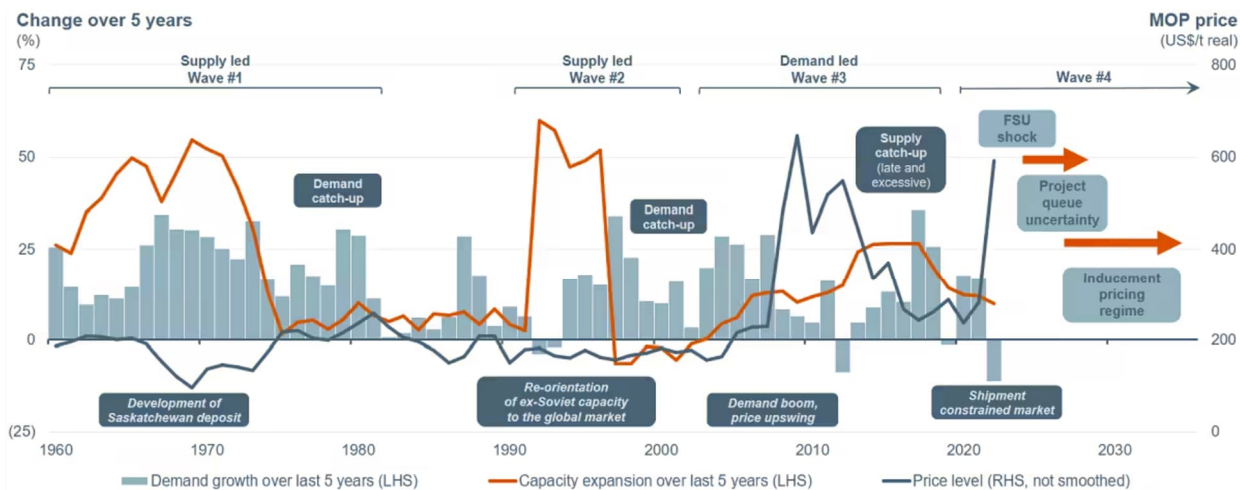

Data: BHP analysis based on multiple sources. Latest datapoint in 2022. FOB Vancouver prices have averaged US\$480/t in 2023 to date, with our latest spot estimate around \$400/t. Note: New supply from FSU is shown in 1990s when existing supply was re-directed from domestic and Eastern Bloc markets after local demand collapsed. Eastern Bloc demand excluded until 1992. 2009 demand excluded.

Figure 16-3: Historical MOP pricing (US\$/t annual average)<sup>2</sup>

### 16.1.3 Competitors

Existing producers collectively sell the vast majority of their MOP on a CFR basis, typically as standalone product, directly to independent bulk buyers, utilizing regional offices, and sometimes agents. Producers typically sell to well over a hundred buyers that collectively form a diverse and competitive demand pool. MOP producers’ geo diverse sales help to balance regional offtake variation that occurs due to local weather conditions, seasons, and crop economics.

Post CFR logistics span from discharge port to 100s of millions of farms around the world. In-market supply chains can be complex. For the most part, in-market distribution is disaggregated and managed by many independent downstream entities. Barriers to entry are often low and margins are often smaller than those captured further upstream.

Where producers choose to sell a portion of their production via their own distribution, manufacturing or retail assets, it is usually done when they want to capture downstream synergy from selling other fertilizers, agricultural products, and/or services. Even in regions where potash producers are particularly active downstream, such as the US and Brazil, the majority of the in-market supply chain remains independently owned.

Competitors currently produce between two and ~fifteen grades of Potash. Product characteristics are principally due to the ‘natural’ result of variation of the mill feed and choice of beneficiation method, but also to suit customers’ needs and preferences. Below is a summary of key potash producers<sup>3</sup>.

2 - The sole purpose of the presented information above is to demonstrate the economic viability of the mineral reserves for the purposes of reporting in accordance with S-K 1300 only and should not be used for other purposes. The information presented does not guarantee future financial or operational performance. The presented information contains forward-looking statements. Please refer to "Note Regarding Forward Looking Statements" at the front of this Technical Report Summary.

3 - Competitor information sourced from each competitor’s corporate website

## **Nutrien**

Nutrien is a member of Canpotex, an export association of Canadian potash producers through which they sell their Canadian potash outside the US and Canada. Nutrien was formed through a merger between Potash Corporation of Saskatchewan and Agrium. The merger officially closed on 01 January 2018 and formed the world's largest provider of crop inputs and fertilizers. Nutrien is the world's largest potash producer with over 20 million tonnes of potash capacity at six potash mines in Saskatchewan. Nutrien sells nine MOP products including speciality products such as soluble grade, turf grade, chiclets, animal feed, micro-nutrients, and pharmaceutical grade.

## **Mosaic**

Mosaic is a member of Canpotex, an export association of Canadian potash producers through which they sell their Canadian potash outside the US and Canada. Mosaic has approximately 10 million tonnes of operational potash capacity. Mosaic sells eight different MOP products including red/white granular and standard products, and crystal turf.

Every year, Canpotex sells a little less than 20 per cent of global MOP sales from Canada, outside North America. These sales are handled on behalf of Nutrien and Mosaic.

## **Uralkali**

Uralkali is one of the leading global producers of potash. The Company accounts for a large share of global potash production. They sell eight different MOP products including: red granular and standard, white fine and standard and potassium chloride pellets.

## **Belaruskali**

Belaruskali is one of the largest state-owned companies of Belarus and one of the largest producers of potash fertilizers in the world, accounting for 20 per cent global supply as of 2019. Belaruskali sells four MOP products including white/red standard and fine MOP.

## **K+S**

K+S Potash Canada is part of the K+S Group, a German-based company that has been mining and processing potash and salt for over 125 years. K+S Potash Canada extracts potash crude salt which is further processed into three types of potassium chloride. K+S is the largest potash producer in Europe. K+S sell four products including pharmaceutical grade MOP.

## **EuroChem**

EuroChem owns and operates plants in Russia, Belgium, Lithuania and China and produces both standard and enhanced nitrogen, phosphate, two potash products, complex fertilizers as well as several industrial product lines.

### **16.1.4 Market Entry Strategies**

The marketing plans are ultimately under the control of the registrant. As such, the Qualified Person has relied upon BHP for this information. In the Qualified Person's opinion and based on industry experience to date, the marketing plans provided by BHP appear to be reasonable in this context.

BHP expects to market directly to major customers via a network of regional offices, leveraging BHP's existing footprint and capabilities.

From a logistics perspective, like other established sellers, BHP intends to focus on upstream cost and freight (CFR) sales. Jansen expects to also benefit from being able to direct-rail to North American customers. Jansen has logistics optionality and flexible granular processing capacity that means it could shift sales between export regions and North America, depending on the market. By staying upstream, Jansen can focus on the highest margin part of the value chain and leverage BHP's experience in exporting bulk commodity marketing and sea-freight.

BHP plans to target dozens of large buyers across growth regions in the Americas, Asia, and the rest of the world, by example Africa, noting Jansen will be under-weight in regions such as China given their historical product preferences. BHP plans to also sell some volumes into the US and other smaller established regions. Geographic and customer diversity is expected to provide competitive global access and average out regional demand variation and price netbacks. Actual sales splits are currently uncertain and depend upon various factors (including regional netback prices, logistics costs, reliability, and the need for location diversity) and vary over time.

BHP is new to potash and intends to become in time one (of only a few) established sellers. Entry risk is present during the ramp up of the mine to the expected production volume. Market conditions at the time of entry are uncertain, and therefore any entry strategy must be fit for purpose under different conditions.

## 16.2 Contracts and Status

All material contracts required for the development of Jansen Potash project are listed below in Table 16-1. The Jansen Project does not intend to have agreements with affiliated parties and plans to create direct purchase engagements.

**Table 16-1: Awarded and pending packages**

Mine Area	Package Description	Stage 1 Awarded	Stage 2 Awarded	Pending Award
General	Cables	X		X
	Communications Equipment	X		X
	E-Houses	X		X
	Filters	X		
	Instrumentation	X		
	Integrated Operations Centre			X
	Mine Load Centres	X		
	Rail Car Loadout System	X		
	Raw Ore/Product Handling Area	X		
	Switchgear	X		X
	Transformers	X		X
	VFDs			X
Mining	Bins	X		X
	Communications Equipment	X		X
	Conveyance	X		X
	Dust Collection	X		X
	Foundations	X		X

Mine Area	Package Description	Stage 1 Awarded	Stage 2 Awarded	Pending Award
Mining	Headframe	X		X
	Headframe Changeover	X	X	
	Hoists	X		X
	Mining Equipment	X		X
	Mobile Equipment	X	X	X
	Power Management System	X		
	Pulleys & Idlers	X		
	Scales and Sensors	X		X
	Underground Development			X
	Underground Equipment	X		
	Ventilation	X		X
Processing	Agitator	X		
	Centrifuges	X	X	
	Compactors	X		X
	Conveyance	X		X
	Coolers	X		X
	Crushers	X		X
	Dry Mill Area	X		X
	Dryers	X	X	
	Ducts			X
	Dust Collection			X
	Flotation	X		X
	Foundations	X		X
	Heat Exchangers (Shell	X		
	Hydrocyclones	X		X
	Maintenance Equipment			X
	Piping	X		X
	Pumps	X		X
	Rail Car Loadout System	X		
	Raw Ore/Product Handling Area			X
	Screens	X		X
	Scrubbers	X		X
	Separators	X		X
	Structural Steel	X		X
Tanks	X			
Thickeners	X		X	
Wet Mill Area	X		X	
Non-Process Infrastructure	Civil Works	X		
	Disposal Wells	X		X
	Earthworks	X		X

For personal use only

Mine Area	Package Description	Stage 1 Awarded	Stage 2 Awarded	Pending Award
Non-Process Infrastructure	Integrated Operations Centre	X		
	Onsite Rail	X		X
	Substation	X		X
	Tailings	X		
Services	Aggregate	X		X
	Camp Management	X		
	Civil Works	X		X
	Concrete Batch Plant	X		X
	Emergency Response	X		X
	Medical Services	X		X
	Site Security	X		X
	Site Services	X		X

In anticipation of Jansen production coming to market, BHP established a dedicated potash marketing team in 2016 to build a practical understanding of how the potash market works. This team has recruited and consulted with many industry experts who collectively have extensive first-hand experience marketing and distributing potash. BHP has spoken with potential potash buyers and developed working relationships with major potash buyers and has non-binding Memorandums of Understanding (MOUs) in place with key strategic buyers. The marketing team is intended to be expanded to bring in more specific regional sales experience as considered to be appropriate. The Qualified Person notes that no potash sales contracts are in place and considers there to be reasonable time to secure sales contracts prior to first production.

## 17 Environmental Studies, Permitting, Plans and Agreements

Operational controls for environmental management are guided by BHP's Charter Values. The Charter Values outline a commitment to develop, implement and maintain management systems for sustainable development that drive continual improvement and set and achieve targets that promote efficient use of resources. The Charter is reinforced by a series Global Standards (GS) documents that have been developed, including *Environment GS*. These enterprise-level documents set out minimum performance requirements to everyone in BHP that must be met to ensure the strategy is delivered, legal obligations are met, defined risks are management and productivity is improved. The Environment GS applies to environment-related risks and potential impacts on the physical environment: air, water, land, biodiversity, communities and their interrelationships.

### 17.1 Environmental Studies and Impact Assessments

The Jansen Project was considered a development subject to the Saskatchewan *Environmental Assessment Act* and required the submission of an Environmental Impact Assessment (EIA). EIAs are used to assess the effect a proposed project may have on the environment by gathering information about the receiving environment and assessing the consequences that planned actions may have on the environment. EIAs help determine the necessary mitigations and other management or remedial measures that may be required for the project to proceed. EIAs define the receiving environment, identify any potential adverse impacts, and propose measures to reduce or prevent these impacts. Controls to manage significant impacts are conditioned in the relevant approval issued by the MOE.

The EIA also determines if any actual or reasonably foreseeable activities conflict with the following conditions, which are outside BHP's appetite for risk and listed in Environment GS, including:

- Do not explore or extract resources within the boundaries of World Heritage listed properties
- Do not explore, extract resources or operate where there is a risk of direct impacts to ecosystems which could result in the extinction of an International Union for Conservation of Nature (IUCN) Red List Threatened Species in the wild.
- Do not dispose of mined waste rock or tailings into a river, surface water body or marine environment. Do not use aqueous film forming foams (AFFF) containing per and poly-fluoroalkyl substances (PFAS) at operated Assets, replace with fluorine free foam products.
- Unless approval is granted:
  - Do not explore or extract resources adjacent to World Heritage listed properties. Approval may be granted only if the proposed activity is demonstrated to be compatible with the outstanding universal values for which the World Heritage property is listed.
  - Do not explore, extract resources or operate within or adjacent to the boundaries of International Union for Conservation of Nature (IUCN) Protected Areas Categories I to IV. If approval is granted, implement a plan that considers



stakeholder and partner (including Indigenous Peoples) expectations and contributes to the values for which the protected area is listed.

In November 2008, BHP Canada submitted a Project Proposal to the Environmental Assessment Branch. After a 30 day public comment period, the Environmental Assessment Branch issued its Project-specific Guidelines, which defined the type of information BHP Canada would need to submit in the Environmental Impact Statement (EIS). The Project Proposal was also sent to the Canadian Federal Government for review in accordance with the Canada-Saskatchewan Agreement on Environmental Assessment Cooperation. Subsequently, the relevant federal agencies determined that there were no triggers for a federal assessment.

BHP Canada completed numerous environmental and socio-economic baselines surveys in 2008 and 2009 to support the EIS, inform environmental permit applications and provide information for management decision making. The survey scopes consist of air, noise, surface and groundwater, soils, wildlife and vegetation and heritage baseline and targeted surveys across BHP Canada's Jansen Project tenure.

Initial public feedback to support the scoping of the baseline surveys and submission of the EIS started in 2009. During the engagement process, a broad range of interested parties were engaged at the federal, provincial, regional and local levels. These included, local communities, Indigenous communities, non-governmental organizations, local business, Crown corporations and government agencies. Within the local communities, potash mining and its effects are generally familiar and well understood and the project received strong overall community and stakeholder support.

In December 2010, BHP Canada submitted the Jansen Project Environmental Impact Statement (EIS) to the Saskatchewan Ministry of Environment (MOE). The EIS and governments technical review were made available to the public for comment. The EIS received Ministerial Approval on 29 June 2011.

Since the EIS approval, further engineering and project optimization was completed that resulted in changes to the mine plan, site layout, and schedule. To maintain Ministerial Approval, two submissions were made in November 2017 to the MOE Environment Assessment and Stewardship Branch under Section 16 of *The Environmental Assessment Act*. The proposed changes included:

- change in ownership of the 7.98 kilometres (km) joint access rail spur connecting the on-site rail to the Canadian Pacific (CP) Railways mainline from CP to BHP Canada;
- increased potash production from 8 to 8.6 million tonnes per annum (Mtpa); and
- expansion of the TMA from 388 to 450 hectares (ha).

Approval was received for both submissions on 19 April 2018. To address a potential increase in production rate, the Project Optimization and EIS Review Summary was submitted and approved on 19 July 2023.

The Jansen Project EIS identified several Valued Ecosystem Components, which were drawn from government requirements, public input, applicable legislation and guidelines, results of baseline studies, the Jansen Project description and the professional judgement of environmental

and social scientists. The Jansen Project Valued Ecosystem Components are listed in the table below (Table 17-1), including mitigation measures.

**Table 17-1: Jansen Project Valued Ecosystem Components and Mitigation Measures**

Valued Ecosystem Components	Mitigation Measures
Air	Use diesel particulate filters, dust suppression, maintaining on-site unpaved roads, air quality will meet government standards for protection of people and the environment
Greenhouse Gas	Subject to Government of Saskatchewan mitigation regulations
Noise	Installation of noise reduction equipment, noise monitoring program to track noise, use best practises with mining equipment to minimize Project-related noise
Soils	Safe disposal of soil contaminants, re-vegetating soil surfaces to prevent wind and water erosion, designing refuelling stations and maintenance facilities to minimize and control spills, usage of seepage interceptor ditches to prevent brine migration
Groundwater	Ongoing monitoring program, control of brine (perimeter dykes and ditches, slurry walls, pile drainage system)
Ground Subsidence	Ongoing monitoring of ground elevation
Plants and Wetlands	Cleaning off-road equipment coming on to site for the first time, limiting soil disturbances, promptly re-vegetating disturbed areas, monitoring invasive plant populations
Wildlife	Habitat Compensation Plan, deterring birds from the brine area as appropriate, no-hunting policy on BHP controlled land, Canadian toad salvage program, avoiding clearing sensitive areas of vegetation during animal breeding seasons, minimizing light on tall site structures
Archaeology and Heritage	Avoid heritage and archaeology sites during construction and mining activities

The Jansen Project EIS found no significant effects on the Valued Ecosystem Components listed above after the proposed mitigation measures.

In accordance with the commitments and conditions in the EIS, long-term environmental monitoring programs were established to monitor for potential environmental effects arising from site operations. A network of monitoring stations was established in 2013 around the boundary of the Project. The monitoring programs include air quality, meteorology, noise, groundwater, wetlands, soils, and wildlife.

BHP Canada committed to developing a habitat compensation program to ensure no net loss of wetlands and associated habitat as a result of the Project. This program started in 2014.

BHP Canada committed to implementing an environmental management program for the Project that follows the framework outlined in the EIS. The Jansen Construction Environment Management Plan (CEMP) describes site specific requirements that have been established for the Project to minimize environmental impacts during construction and future operations. The CEMP incorporates internal BHP environmental standards, federal and provincial environmental standards, and Project regulatory approval requirements.

## 17.2 Waste and tailings disposal

BHP’s commitment to safe tailings management, the Global Industry Standard on Tailings Management (GISTM) and our ambition to achieve zero harm from tailings is outlined in the BHP Tailings Storage Facilities (TSF) Policy Statement available on bhp.com (see downloads section) as approved by the BHP Board in June 2023.

The BHP Tailings Policy outlines our approach to TSF management including:

For personal use only

- governance and risk management;
- Transparency and disclosure; and
- Emergency preparedness and response and mechanisms for recovery.

Mandatory minimum performance requirements for TSFs govern how we manage TSF failure risks across BHP and are aligned with the GISTM (and outlined applicable processes and associated internal guidance). This is publicly available as the Tailings and Water Storage Facilities GS (see link to external GS above).

BHP has developed short-, medium- and long-term tailings management strategies.

- Our short-term strategy continues to focus on improving Key Risk Indicator performance in line with defined targets.
- Our medium- and long-term strategies focus on complex risk reduction projects and the identification and use of improved tailings management and storage solutions.

### 17.2.1 Waste and Tailings Disposal

The waste produced from the mill will consist primarily of fine tailings (insoluble), coarse salt tailings, and sodium chloride brine. All tailings will be stored within the TMA. Separate coarse and fine tailings cells will store the respective waste products. A brine recycling system connected to the coarse tailings cell will provide brine management for reuse by the mill. Excess brine from operations or resulting from precipitation events will be pumped from the coarse tailings cell to the disposal wellfield for injection into the deep Winnipeg-Deadwood Formation.

A combination of dykes, drains and interceptor ditches are intended to be used to contain the tailings and brine. The coarse tailings facility consists of a tailings and brine storage area surrounded by perimeter earthen dykes. The facility is designed to store the Environmental Design Flood (EDF) while maintaining minimum freeboard requirements. The EDF is equal to a 1:100-year precipitation event occurring over a 24-hour period. Additional flood storage will be available for precipitation events exceeding the EDF up to the Inflow Design Flood (IDF). This will be done by utilizing overflow spillways constructed into the crest of the coarse tailings area dykes. The overflow spillways will allow for brine transfer into the interceptor ditches for temporary storage. The IDF used for design is 300 millimetres in 24 hours, which is slightly greater than the calculated IDF for high Canadian Dam Association (CDA) consequence dam of 1/3 m between 1:1,000-year and the rational Probable Maximum Precipitation (PMP). As the coarse tailings volume increases with production, a phased expansion of additional cells will be incorporated to maintain coarse tailings and flood storage capacity.

The fine tailings facility will consist of a tailings storage, filter dyke, brine decant pond, and tailings underdrainage system, surrounded by perimeter earthen dykes. This facility is designed to store the fine tailings produced during operations and clarify the associated brine through surface transport and filtration through the filter dyke. The fine tailings cell is designed to contain the IDF within a 24-hour period, while maintaining the minimum freeboard requirements. As fine tailings volumes increase with production, a perimeter downstream dyke raise and phased expansion of additional cells will be incorporated to maintain fine tailings and flood storage capacity.

A network of interceptor ditches will surround the TMA. These ditches are designed to intercept lateral brine migration under the perimeter dykes. These ditches are also designed to collect brine from the toe drains, located on the downstream side of the dykes. The base of the interceptor ditches will be keyed into the underlying low permeability unoxidized till. Brine collected in these ditches will be directed to a sloped collection point, where it will be pumped back into the TMA.

Slurry walls will be constructed as required in the future to mitigate migration of brine in the Upper and Lower Floral Aquifers from the area underlying the TMA. The timing of the slurry wall installations will be based on the results of regular monitoring of groundwater wells installed in these aquifer units.

### 17.2.2 Site Monitoring

Visual inspections of the TMA dykes and ditches will be completed on an annual basis by an independent geotechnical engineer. A comprehensive annual visual dyke inspection (AVDI) will be conducted to visually examine the containment structures and qualitatively evaluate the stability of the structures based on the observed appearance. The emphasis of the AVDI will be to identify any observable danger signs associated with failure mechanisms of the structures. The findings will be provided to the MOE.

Geotechnical monitoring instrumentation will consist of slope inclinometers, vibrating wire piezometers and standpipe piezometers installed to varying depths within the dyke, coarse tailings pile, and foundation soils to monitor pore water pressures and stability conditions. Geotechnical monitoring instrumentation are to be installed in the dykes and pile foundation soils shortly after construction, with a continuous growing network of instrumentation installed in the tailings pile as it grows to facilitate management of the facility.

The minimum calculated Factor of Safety (FOS) equal to 1.5 is presently required for containment dykes, as per the Saskatchewan Potash Industry Brine Pond Freeboard Guidelines and Reporting Requirements (MOE, 2018). The calculated FOS is modelled assuming the brine pond levels at the maximum flood storage level with all modelled dyke cross-sections exceeding the minimum FOS of 1.5. A minimum calculated FOS equal to 1.3 is required for all segments of the coarse tailings pile.

Site monitoring of environmental risks including brine migration outside of the TMA footprint will be completed predominantly through groundwater and surface water monitoring programs. A long-term groundwater monitoring plan was established for the Project in 2012. The objectives of the environmental monitoring are to detect and estimate the rate of lateral brine migration from the TMA and the extent and magnitude of drawdown due to groundwater extraction. Throughout operations, groundwater levels, surface water and groundwater water chemistry, and electromagnetic survey data will be collected and analysed in accordance with the Site's Approval to Operate.

### 17.2.3 Water Management

In accordance with the Water Management GS, the Project maintains a quantitative water balance. The water balance provides a summary of the meteorological data, camp occupancy, pond levels, and inputs and outputs.

In production, the raw water system will consist of the incoming water supply line from SaskWater, raw water pond, and main pump house. This area will provide raw water to the plant, for fire protection and to the operating facilities. The onsite storm water pond was designed for zero discharge; however, design changes have resulted in a requirement for construction phase discharge from the pond. Permits are issued by provincial regulatory agencies to discharge annually. During construction and operation, potable water will be supplied through the operating and permitted centralized water treatment system.

## 17.3 Project Permitting and Approvals

### Construction and Operation Environmental Permits

Following the Approval of the EIS, the Jansen Project required federal, provincial and municipal permits and approval for construction and operation. BHP Canada has received all permits that have been applied for to-date and do not anticipate any risks to obtaining the required construction and operation permits for the Project.

The Project maintains an electronic permit register that lists all permits for the Project, which contains the permit details, requirements, and expiration dates. An internal notification system alerts the applicable parties when permits are up for renewal.

### Decommissioning and Reclamation Plan

A Decommissioning and Reclamation (D&R) Plan has been developed in accordance with the Saskatchewan *Mineral Industry Environmental Protection Regulations*, Jansen EIS Commitments and EIS Approval. Provincial regulations also require that financial assurance be provided for the mining operations to ensure there are sufficient funds available for the necessary D&R activities. The D&R Plan was developed to provide information and costs on the concepts that would be implemented in the event the Jansen Project was to close in December 2021 and discusses the safety and security of the site, the decommission and reclamation concepts and addresses the residual risks of the Project through monitoring programs. In accordance with the *Mineral Industry Environmental Protection Regulations*, BHP Canada is required to submit and review the D&R Plan and financial assurance every five years. BHP Canada submitted and received approval for the first D&R Plan in 2016 and submitted a revised D&R Plan in 2021 and received approval in 2022. The next D&R Plan will be submitted in 2026.

### Heritage

In 2009, a Heritage Resource Impact Assessment (HRIA) was completed to support the submission of the Jansen Environmental Impact Statement (EIS). The HRIA involved pedestrian surveys, documentation of existing heritage features and informal interviews. Three heritage sites were identified, one prehistoric archaeological site and two historic built heritage sites. The Heritage Conservation Branch (HCB) determined that no further work was required at the two historic built heritage sites. With respect to the third site, a Heritage Resource Impact Assessment (HRIA) was completed in May 2021. The assessment was submitted and the Saskatchewan Heritage Conservation Branch determined all HRIA regulatory requirements had been satisfactorily completed, and there are no concerns with the project proceeding as planned.

## 17.4 Social Plans and Agreements

In the case of Jansen, no aboriginal rights were impacted by the project, the Duty to Consult with Indigenous groups was not triggered. However, during the development of the Jansen project, BHP Canada negotiated voluntary agreements with six local Indigenous communities to provide a basis for collaboration and for effective ongoing communication. As part of the agreements, commitments to capacity building initiatives on education, training and labour force development and addresses sharing of information important to environmental management practices. The agreements are planned to be refreshed every five years.

## 17.5 Closure Planning

### Conceptual Closure Plan and Associated Costs

A Conceptual Closure Plan has been developed with the Jansen Project which considers up to four stages of expansion. The main areas include the mine site, raw ore handling and storage, process plant, tailings and brine disposal, product storage and loadout, non-process infrastructure and onsite rail, joint access spurs and wyes. The objective of the closure activities is to achieve the conditions for physical and chemical stability of the mine site, similar to its pre-development condition and land use, to ensure public safety and environmental protection. Specific stakeholder consultation relating to closure has not been conducted to date but will be undertaken based on the stakeholder engagement strategy for the Project.

Progressive reclamation is the reclamation of areas no longer required for operations and provides a potential means to enable a cost-effective, timely closure. It is anticipated that the majority of the Project site will be actively utilized while the mine is operational and therefore opportunities for progressive reclamation may be limited.

Site decommissioning will be staged, first with the mine site, then process facilities and finally the TMA. All buildings and associated infrastructure will be decommissioned and demolished once no longer required for long-term closure activities. All waste will be classified as either hazardous or non-hazardous and disposed accordingly.

The TMA at closure will consist of the fine and coarse TMAs. The fine tailings are expected to consolidate to enable access for equipment to cover with granular fill, soil and re-vegetate. The coarse TMA will be closed and reclaimed through either natural or enhanced dissolution. The current conceptual closure plan for coarse tailings involves long-term natural dissolution by precipitation, and the collection and disposal of the resulting brine through brine disposal wells into the Winnipeg-Deadwood Formation, which are highly saline aquifers below the mining horizon. Enhanced dissolution involves the water sources identified in natural dissolution as well as utilizing poor quality water (unusable for consumption or irrigation) from an aquifer.

The end uses for the rehabilitated site are currently identified as a mix of agricultural and wetland/upland habitat, but will be subject to future stakeholder discussions.

An environmental monitoring and maintenance program will be conducted to assess the physical, chemical, and biological stability of the rehabilitated mine, where necessary, proactively identify areas where maintenance is required. The intention of this program is to confirm whether the site closure criteria have been achieved, and to ensure the closure activities are progressing successfully towards meeting these criteria and attaining the close out status.

The conceptual closure cost model is made up of a detailed direct cost estimate for each of the reclamation activities identified for each project component. Despite the detailed estimation of the closure costs, there is a vast amount of time before the closure plan is to be executed, and consequently limits the accuracy of the cost, with the current conceptual closure plan representing one of many possible closure options. BHP Canada continues to work with the relevant provincial ministries to maintain an appropriate level of financial security for mine closure requirements.

The conceptual closure costs are represented in the economic evaluation as a lump sum one year after active mining stops, with primary closure of the mine site buildings, processing plant, and non-process infrastructure occurring approximately within the first five years of closure. An annual cost of CA\$2.7M, exclusive of indirect costs and contingency, is captured in the economic evaluation for the duration of the post closure monitoring, maintenance, and the reclamation of coarse tailings, accomplished through long-term dissolution by precipitation, collection, and disposal of the resulting brine through disposal wells, and the reclamation of said disposal wells. The closure cost estimate is CA\$2.4B, excluding contingency and indirect costs.

## 17.6 Local procurement and hiring

BHP works in partnership with Indigenous peoples around the world. The success of these relationships is critical to our success as a company.

BHP is committed to supporting the communities in which we operate through the delivery of local industry participation benefits.

### **Local and Indigenous Procurement**

The Jansen Project brings significant potential for involving Indigenous and local contractors and suppliers with a focus on First Nation organizations. BHP Canada has signed voluntary Opportunity Agreements (OAs) with communities near the Jansen Project as follows: Kawacatoose First Nation, Day Star First Nation, Muskowekwan First Nation, Beardy's and Okemasis' Cree Nation, Fishing Lake First Nation, and George Gordon First Nation. The purpose of the OAs is to enable a collaborative working relationship between the First Nations and BHP Canada by providing business and economic, employment, training and community development opportunities. This, in addition to the introduction of 7-day payment terms for all small, local and Indigenous owned businesses, which took effect in June 2021.

### **Local and Indigenous Hiring**

During Jansen mine operations, BHP Canada has publicly stated our intent is that our Indigenous workforce reflects the underlying demographic of the region. For more on Indigenous hiring, please see Section 17.4 on social value and agreements.

Additionally, BHP Canada is expected to implement processes designed to increase Indigenous and female participation in employment opportunities independent of the apprenticeship program.

## 17.7 Discussion of Relative Accuracy/Confidence

In the Qualified Persons opinion, the risks associated with environmental compliance and permitting, water management and cultural heritage are well understood and managed in accordance with BHP's Global Standards for *Health, Environment, Community and Indigenous*

*Peoples, Closure and Legacy Management* and regulatory requirements. BHP's approach to social investment and commitment to the local communities has resulted in long-term relationships that will continue for the life of the project.

In the opinion of the Qualified Person, there is a high likelihood that changes to the closure plan and cost will occur as it progresses from conceptual design to detailed design. The closure management plans should be regularly reviewed to reflect updated asset planning and include current knowledge from on-site experience, regionally, across other BHP businesses, and globally in the mining industry.

For personal use only



## 18 Capital and Operating Costs

### 18.1 Operating Cost

#### 18.1.1 Operating Cost Estimate

The operating cost estimate for Jansen were developed to capture costs defined as mine gate. This includes all costs spanning from the mining face underground to the loading of product to rail at the site.

The operating cost estimate includes all personnel and activities within the battery limits of the scope, and includes operational and statutory management, administration, and support personnel associated with the operation. Specifically, the operating cost estimate captures all costs related to:

- Mining operations and maintenance
- Processing operations and maintenance
- Non-process infrastructure operations and maintenance
- Indirect costs including:
  - costs associated with the Saskatoon Integrated Operations Centre (IOC)
  - Marketing and selling costs
  - Intra-Group Service Charges (IGSC's) and share & executive awards
- Carbon costs and applicable sales tax
- Sustaining capital associated with any of the items identified

There are tax-related expenses that will be incurred by Jansen that are not covered in the operating cost estimate and are instead captured within the economic analysis separately. These include:

- Royalties (including Crown royalties and Saskatchewan resource surcharge)
- Business income taxes including potash production taxes, federal income taxes and provincial income taxes)

The operating cost inputs and drivers have been primarily sourced from bottom-up estimates, operational experience and benchmarking, budget quotes from potential vendors, design specifications, and currently contracted rates where applicable. The operating cost estimate for Jansen Project is developed to an accuracy level within a +/-25% range. The estimate includes costs from all areas from the mine face up to and including the load out operations. Table 18-1 reflects the operating cost in US\$ equivalent with breakout between variable and fixed costs. The aggregated operating cost is derived by adding the product variable costs to the result of dividing the fixed costs and sustaining capital by the expected 8.5 Mt of saleable product per annum, yielding US\$/t KCl.

**Table 18-1: Major Components of Operating Costs for Jansen Mine<sup>4</sup>**

<b>Cost Category (Real 2024)</b>	<b>Cost Sub Category</b>	<b>US\$/t KCI</b>
<b>Product Variable Costs</b>	Mine Operating Costs	1
	Processing Operating Costs	9
	Non-Process Infrastructure (NPI)	1
	Other Variable Costs	23
		<b>US\$M</b>
<b>Fixed Costs</b>	Mine Operating Costs	124
	Processing Operating Costs	86
	Indirect	49
	Non-Process Infrastructure (NPI)	15
	Other Fixed Costs	91
<b>Sustaining Capital</b>		<b>108</b>

Variable costs in each of the areas referenced in Table 18-1 include production consumables, utilities (power, natural gas, diesel, and water), as well as processing reagents as the primary drivers. These costs will be incurred with the start of saleable product being produced. All consumption values per tonne were estimated considering the Jansen engineering design and benchmarked estimates from our Potash SME team. The unit costs used in the variable cost calculations were sourced from budget quotes from local vendors as well as publicly available information where possible.

Fixed costs within each area consist of labour and maintenance as the primary drivers. Fixed costs are displayed as an annual basis and are applied over the life of mine. Labour costs unit rates referenced locally benchmarked labour rates in the region with total headcount estimated utilizing the Jansen mining and processing design. Maintenance costs utilized benchmarked annual costs for known equipment types multiplied with the known asset counts from within the design. Indirect costs were developed reviewing the current BHP benchmarked costs from other assets while considering the Potash specific work requirements.

Sustaining capital costs take into account the continued development of the mine and need to install additional material handling infrastructure. Other main drivers within sustaining capital are major maintenance programs, asset replacement, and tailings area expansions throughout the life of the mine. Sustaining capital is treated as and embedded with the operating expenses.

<sup>4</sup> - The sole purpose of the presented information above is to demonstrate the economic viability of the mineral reserves for the purposes of reporting in accordance with S-K 1300 only and should not be used for other purposes. The annual cash flow data was prepared based upon Pre-Feasibility-level studies and the historic average prices and costs described in this Technical Report Summary; it is subject to change as assumptions and inputs are updated. The information presented does not guarantee future financial or operational performance. The presented information contains forward-looking statements. Please refer to "Note Regarding Forward Looking Statements" at the front of this Technical Report Summary.

### 18.1.2 Basis and Accuracy Level for Cost Estimates

The cost estimation procedure and the uncertainty analysis for the operating cost of the project has been reviewed and analysed by an independent 3<sup>rd</sup> party team to remove potential bias from the process. The uncertainty analysis was facilitated by the 3<sup>rd</sup> party team and utilized external subject matter experts. All outputs of the estimated process have been reviewed and approved as accurate in the opinion of the qualified person and are within level of accuracy stated at the time that they were developed. At the conclusion of the process the mid case estimate outlined within this document was acknowledged as within the range of accuracy with limited changes suggested.

The results of the ranging exercises determined the contingency for mine gate, on site rail, and sustaining capital fall within the 15% allowable contingency in a prefeasibility study. Contingency is developed for the Operating Cost estimate and applied within the economic analysis and economic evaluation modelling.

The culmination of the ranging exercises resulted in contingencies appropriate to prefeasibility accuracy, which were developed for the Operating Cost estimate and applied within the economic analysis, decision evaluation modelling.

The final resulting estimate that was utilized in the cost analysis was reviewed and endorsed by the operating cost estimate owner and deemed suitable for use in the opinion of the qualified person within the accuracy stated within this document.

## 18.2 Capital Cost

### 18.2.1 Capital Cost Estimate

The Jansen Project Capital Cost Estimate (Capex) was developed by BHP Canada, its consultants and engineering service providers. Communications, power, water, and natural gas are provided by provincial crown corporations. Connections to the water and natural gas infrastructure are complete. The scope for Jansen Project is comprised of:

- A fully lined service shaft with permanent hoists capable of 1,750 tph, equipped with steel guides and loading/unloading to accommodate two 50-tonne skips and a 90-person service cage;
- A fully lined production shaft. The existing sinking arrangement will undergo a hoist and headframe changeover to accommodate the interim hoisting requirements for the lateral connection of the two shafts and subsequent shaft pillar development. The interim arrangement of the production shaft will be changed over to a permanent arrangement equipped with steel guides and loading/unloading to accommodate two 75-tonne skips capable of 2,200 tph to 2,700 tph of hoisting, noting engineering is ongoing.
- A shaft pillar area with skip loading facilities, conveyor networks, raw ore storage bin (vertical), remote storage area (horizontal), refuge stations, workshops, materials management areas, offices, principal refuge chambers, mobile equipment battery charging stations, and parking areas.

- Establishment of three mining districts that host the production mining panels and supporting development units, and are connected to the shaft infrastructure through conveyor networks.
- Production and development mining equipment, including MF460 borers, extendable belt systems, continuous miners, batch haulage, and supporting fleet of underground personnel and service vehicles;
- Two 1,483 tph ore processing plants including:
  - Raw ore handling, storage, and crushing
  - Process mill building wet area comprising attrition scrubbing, desliming, flotation, and debrining
  - Process mill building dry area comprising drying, screening, compaction, and glazing
  - Tailings processing and reagents
  - Product handling, storage, screening, and loadout

Non-process infrastructure, including a tailings management area, administration building, warehousing, workshops, utilities, on-site rail, and financial support for port facility conversion to ship product to overseas markets.

The majority of the direct cost estimate is based on engineering designs which include design drawings, 3D models, equipment, and instrument lists based on process flow diagrams and piping and instrumentation diagrams, and other engineered quantities. The capex estimate includes quantities for common indirects, implementation contractor services (EPCM), owner's team that are based on personnel requirements for the duration of the project. Provincial sales taxes are calculated based on Saskatchewan tax regulations. Escalation estimates during execution are calculated based on IHS Markit indexes for various commodities and labour types.

The majority of the direct bulks and equipment supply pricing is based on budget pricing from the market. Some of the packages were at very advanced stages of development thus had been awarded to the vendors at the time of study completion. The majority of the direct trade labour rates are based on input from the tier 1 construction contractors as well as the negotiated project labour agreement with the trade unions. In the opinion of the Qualified Person, based on the engineering, execution schedule, project execution plan, market pricing and labour pricing information available at the time of study, the capex estimate includes all required elements of cost to cover the defined scope and is appropriate for the project.

Total Jansen Mine capex summary is as follows (Table 18-2). Sunk costs are exclusive; economic evaluation is performed using go forward costing.

For personal use only

**Table 18-2: Jansen Capex by Area, US\$B (Real 2024)<sup>5</sup>**

Description	Total Sunk Projected at end of FY24	Total to go FY25 Onwards	Grand Total Capex
Mining	0.9	2.7	3.6
Surface	1.5	3.9	5.4
<b>Total</b>	<b>2.4</b>	<b>6.6</b>	<b>9.0</b>

All costs in Table 18-2 exclude escalation and inflation. Capital expenditure is aligned with mine gate prices and therefore exclude all port and off-site rail.

### 18.2.2 Basis and Accuracy Level for Cost Estimates

The majority of the quantities are developed from design drawings, 3D models, equipment, and instrument lists based on process flow diagrams, piping and instrumentation diagrams, and other engineered quantities. The majority of the pricing of bulks and plant equipment is sourced from the market.

The uncertainty and risk analysis for capex has been facilitated by a 3<sup>rd</sup> party team to remove potential bias from the ranging process, however BHP Canada led the effort for model and results. In the opinion of the Qualified Person, the process undertaken for ranging is appropriate and based on the project information available at the time of study, covers for all the uncertainties and risks that the project may be subject to during execution. The team that ranged the risks and uncertainties consisted of both internal and external subject matter experts while applying the ranging methodology as described below:

- Estimate roll-up of cost and schedule
- Solicitation of ranges from various internal and external subject matter experts
- Range modelling and analysis
- Incorporating Jansen Independent Peer Review recommendations
- Final results and reporting

Uncertainties and risks are quantified by the following ranging categories:

- Scope of work

<sup>5</sup> - The sole purpose of the presented information above is to demonstrate the economic viability of the mineral reserves for the purposes of reporting in accordance with S-K 1300 only and should not be used for other purposes. The annual cash flow data was prepared based upon Pre-Feasibility-level studies and the historic average prices and costs described in this Technical Report Summary; it is subject to change as assumptions and inputs are updated. The information presented does not guarantee future financial or operational performance. The presented information contains forward-looking statements. Please refer to "Note Regarding Forward Looking Statements" at the front of this Technical Report Summary.

- Labour or service rates
- Labour productivity
- Supply rates of equipment and bulks
- Discrete project risks

The culmination of the ranging inputs available at the time of risks and uncertainties assessment has the economic testing completed with a total installed cost (TIC) of Real US\$9.0 billion. This represents an expected contingency of up to but not exceeding 15 per cent of the total installed cost. The accuracy range around the expected overall capex is +/-25 per cent. In the opinion of the Qualified Person, based on the technical information available and associated ranging on this information at the time, resulting contingency and ranges are appropriate for the project to cover for uncertainties and risks during execution.

## 19 Economic Analysis

### 19.1 Key assumptions, parameters and methods used

The economic analysis presented in this section is based on annual cash flow projections including sales revenue (sales point FOB Mine), operating and closure costs, capital expenditures, royalties, income and production taxes.

#### 19.1.1 Mine Plan Physicals

The mine production is modelled on an expected basis. The expected value is considered to be the most likely outcome when considering a range and likelihood of possible scenarios. The Expected run-of-mine (RoM) production is 23.4 Mtpa, life of mine grade of 24.8 per cent K<sub>2</sub>O, recovery of 88 per cent and a concentrate of 60.4 per cent K<sub>2</sub>O resulting in a life of mine average of 8.5 Mt of saleable product per annum. The development of the reserves generated is available in Section 12 and the mining profile is presented in Sections 13 and 14. Jansen expected annual run-of-mine production and expected run-of-mine grade is presented in Figure 13-4.

#### 19.1.2 Potash Price

The sales point is assumed as mine gate with annual revenue determined by applying the through cycle historic average price of US\$391/t FOB mine (Saskatoon, Real 2024 basis) to the annual life of mine production. The development of the historic average pricing is outlined in Section 16 of this document.

#### 19.1.3 Foreign Exchange Rate

Inputs into the economic analysis are primarily in Canadian dollars with some United States dollars inputs. An average foreign exchange rate for the preceding three financial years (July 2020 to June 2023) of 1.30 CA\$/US\$ was provided by the registrant to convert and present cash flows in US dollars.

#### 19.1.4 Capital and Operating Costs

Capital costs (refer Section 18.2) prior to FY2024 have been treated as sunk costs and are not included in the analysis. Capital expenditure is aligned with mine gate prices and therefore exclude all port capital requirements.

Sustaining capital and average operating cost over the life of mine is illustrated in Section 18.1, Table 18-1. Operating costs are aligned with mine gate prices and therefore exclude all port cost.

#### 19.1.5 Closure Costs

Closure and rehabilitation costs are included in the economic analysis following the end of mine life (refer Section 17.5 Closure Planning).

#### 19.1.6 Royalties and Taxes

BHP Canada's potash mining operations will be subject to the following royalties and taxes in Canada:

Saskatchewan Crown Royalties: Royalties of 3 per cent of the value of potash produced based on the average price realized by the producer in the year as determined by revenues and sales under The Potash Production Tax Regulations.

Saskatchewan Resource Surcharge: The Resource Surcharge is a corporate capital tax levied at a rate of 3 per cent of the value of sales of potash in Saskatchewan.

Saskatchewan Municipal and School Taxes: Saskatchewan property taxes are levied by municipal councils and school boards to support local infrastructure and school programs.

Saskatchewan Potash Production Tax: The Government of Saskatchewan imposes a Potash Production Tax comprising two components, a Base Payment and a Profit Tax.

Corporate Income Taxes: The Government of Canada and the Government of Saskatchewan charge corporate income tax at rates of 15 per cent and 12 per cent, respectively, for a combined rate of 27 per cent of taxable income for the year. Saskatchewan Crown Royalties, Resource Surcharge, Municipal and School taxes, and Potash Production Tax are deductible for Corporate Income Tax purposes.

#### 19.1.7 Valuation Assumptions

Discounted annual cash flows are calculated using a 7.0 per cent real, post-tax discount rate at a valuation date of 2024. The discount rate has been provided by the registrant for utilisation in the economic analysis and is based on the average of weighted average cost of capital disclosures by brokers, adjusted where required for inflation of 2.0 per cent per annum.

For personal use only



## 19.2 Results of Economic Analysis

Results of the economic analysis based on the LoA production schedule of Jansen project mineral reserves is summarised in Figure 19-1.

Total cash flow forecast of US\$64.3 billion, discounted to June 2024 at 7.0 per cent results in a net present value (NPV) of US\$11.2 billion. Refer to Table 19-1.<sup>6</sup>

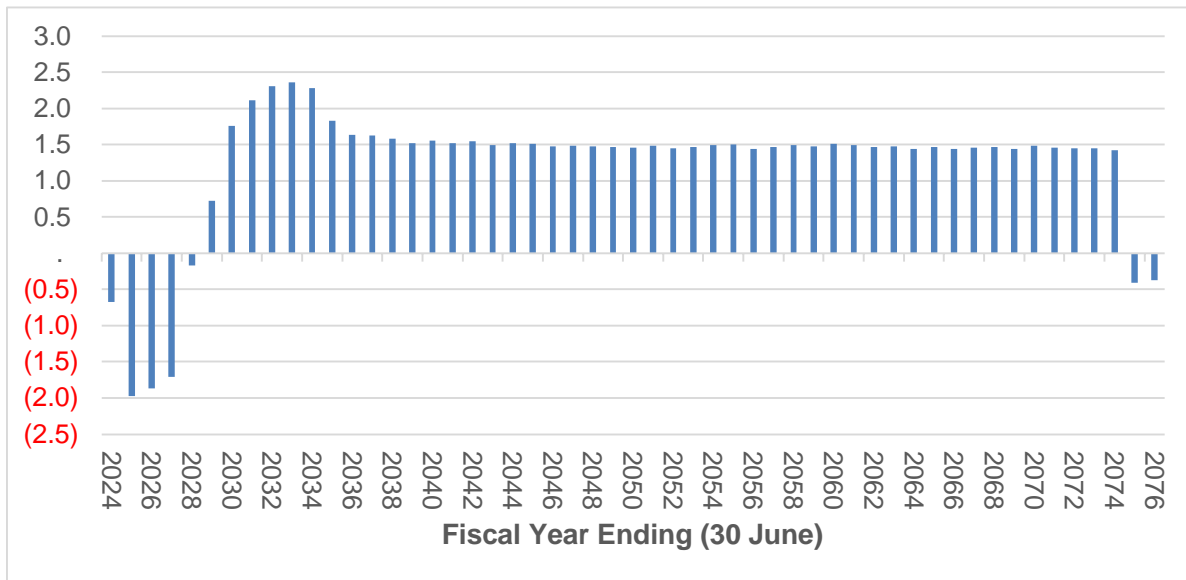

**Figure 19-1: Annual Cash Flow (US\$B Real 2024)**

The cash flow summary on an annual basis is provided in Table 19-1 below. The annual cash flow is presented with the inputs grouped in time periods where the annual inputs for each year are substantially the same throughout the relevant grouped period.

<sup>6</sup> - The sole purpose of the presented information above is to demonstrate the economic viability of the mineral reserves for the purposes of reporting in accordance with S-K 1300 only and should not be used for other purposes. The annual cash flow data was prepared based upon Pre-Feasibility-level studies and the historic average prices and costs described in this Technical Report Summary; it is subject to change as assumptions and inputs are updated. The information presented does not guarantee future financial or operational performance. The presented information contains forward-looking statements. Please refer to "Note Regarding Forward Looking Statements" at the front of this Technical Report Summary.

**Table 19-1: Annual Cash Flow and Summary<sup>7</sup>**

Mineral Reserves Economic Viability		Average per financial year ending 30 June					
		Total	2024-2026	2027-2031	2032-2073	2074-2075	2076+
Material movement including waste	Mt	1,070	-	11.7	23.4	12.2	-
Revenue	US\$ billion	151.1	-	1.6	3.3	1.7	-
Operating costs	US\$ billion	(30.9)	(0.0)	(0.4)	(0.7)	(0.6)	-
Capital Expenditures (includes Sustaining)	US\$ billion	(12.6)	(1.5)	(0.6)	(0.1)	(0.1)	-
Closure & rehabilitation	US\$ billion	(0.4)	-	0.0	0.0	0.0	(0.4)
Royalties and taxes <sup>8</sup>	US\$ billion	(42.8)	-	(0.1)	(1.0)	(0.5)	-
After-tax cash flow	US\$ billion	64.3	(1.5)	0.5	1.6	0.5	(0.4) <sup>9</sup>
Discount cash flow	US\$ billion	11.2	(1.3)	0.3	0.3	0.0	(0.0)

The annual projected cash flow presented in Figure 19-1 and Table 19-1 includes all closure and rehabilitation related annual cash flows summed after the final year of mineral reserve production.

The internal rate of return (IRR) is 18.3 per cent and the payback period is 8 years following first production. It is the Qualified Person's opinion that extraction of the mineral reserve is economically viable.

### 19.3 Sensitivity Analysis

Economic sensitivity analysis results are presented in Table 19-2 are based on variations in significant input parameters and assumptions. It is noted that the top three influencing factors in the economic testing are the sale price of the product, process throughput connected to the uncertainty of the production mining system performance, and process recovery. The tested scenarios all yielded a positive return.

<sup>7</sup> - The sole purpose of the presented information above is to demonstrate the economic viability of the mineral reserves for the purposes of reporting in accordance with S-K 1300 only and should not be used for other purposes. The annual cash flow data was prepared based upon Pre-Feasibility-level studies and the historic average prices and costs described in this Technical Report Summary; it is subject to change as assumptions and inputs are updated. The information presented does not guarantee future financial or operational performance. The presented information contains forward-looking statements. Please refer to "Note Regarding Forward Looking Statements" at the front of this Technical Report Summary.

<sup>8</sup> - Taxes includes royalties

<sup>9</sup> - Includes the terminal value of C\$2.7M in annual post closure monitoring costs

**Table 19-2: Results of sensitivity analysis (Unrisked NPV US\$B)**<sup>10</sup>

	-20%	-10%	Reference	+10%	+20%
Potash price (FOB mine)	7.1	9.2	11.2	13.2	15.2
Throughput	7.3	9.3	11.2	13.1	15.0
Grade	7.8	9.5	11.2	12.8	14.3
Recovery	7.3	9.3	11.2	13.1	13.7
Exchange Rate	9.6	10.5	11.2	11.7	12.2
Capital expenditure (Execution)	11.6	11.4	11.2	10.8	9.8
Operating costs	11.8	11.5	11.2	10.9	10.4

<sup>10</sup> - The sole purpose of the presented information above is to demonstrate the economic viability of the mineral reserves for the purposes of reporting in accordance with S-K 1300 only and should not be used for other purposes. The annual cash flow data was prepared based upon Pre-Feasibility-level studies and the historic average prices and costs described in this Technical Report Summary; it is subject to change as assumptions and inputs are updated. The information presented does not guarantee future financial or operational performance. The presented information contains forward-looking statements. Please refer to "Note Regarding Forward Looking Statements" at the front of this Technical Report Summary.

## 20 Adjacent Properties

Figure 20-1 shows the properties and their owners adjacent to the Jansen project. BHP Canada owns additional potash dispositions north, south, and south-east of Jansen. Exploration on the KL 218, KL 211 (Burr) and on KL 205, KL 206, KL 207 (Boulder) properties includes 2D seismic surveys followed by some 3D seismic surveys and limited drilling.

West of Jansen is Nutrien's Lanigan operation (KLSA 001). Publicly available NI 43-101 reports indicate that the Lanigan operation has extracted potash from the same LPL sub-member as Jansen is planning to mine since production began in 1968. Since 2007 the Lanigan operation has also expanded mining to the UPL sub-member. Lanigan currently operates three disposal wells that inject waste brine into the Winnipeg and Deadwood formations.

Based on the Saskatchewan Ministry of Energy and resources information the KL 282 Potash disposition north, north-east of Jansen is owned by Canada Golden Fortune Potash Corp. a wholly owned Canadian subsidiary of the Shanghai Jingdi Investment Ltd. company based in Shanghai, China. The company's website indicates that exploration activities at the property were limited to 2D seismic surveys.

The Qualified Person states that they have been unable to verify the information available from the adjacent properties and that the available information is not necessarily indicative of the quality and nature of mineralization present at the Jansen property.

For personal use only

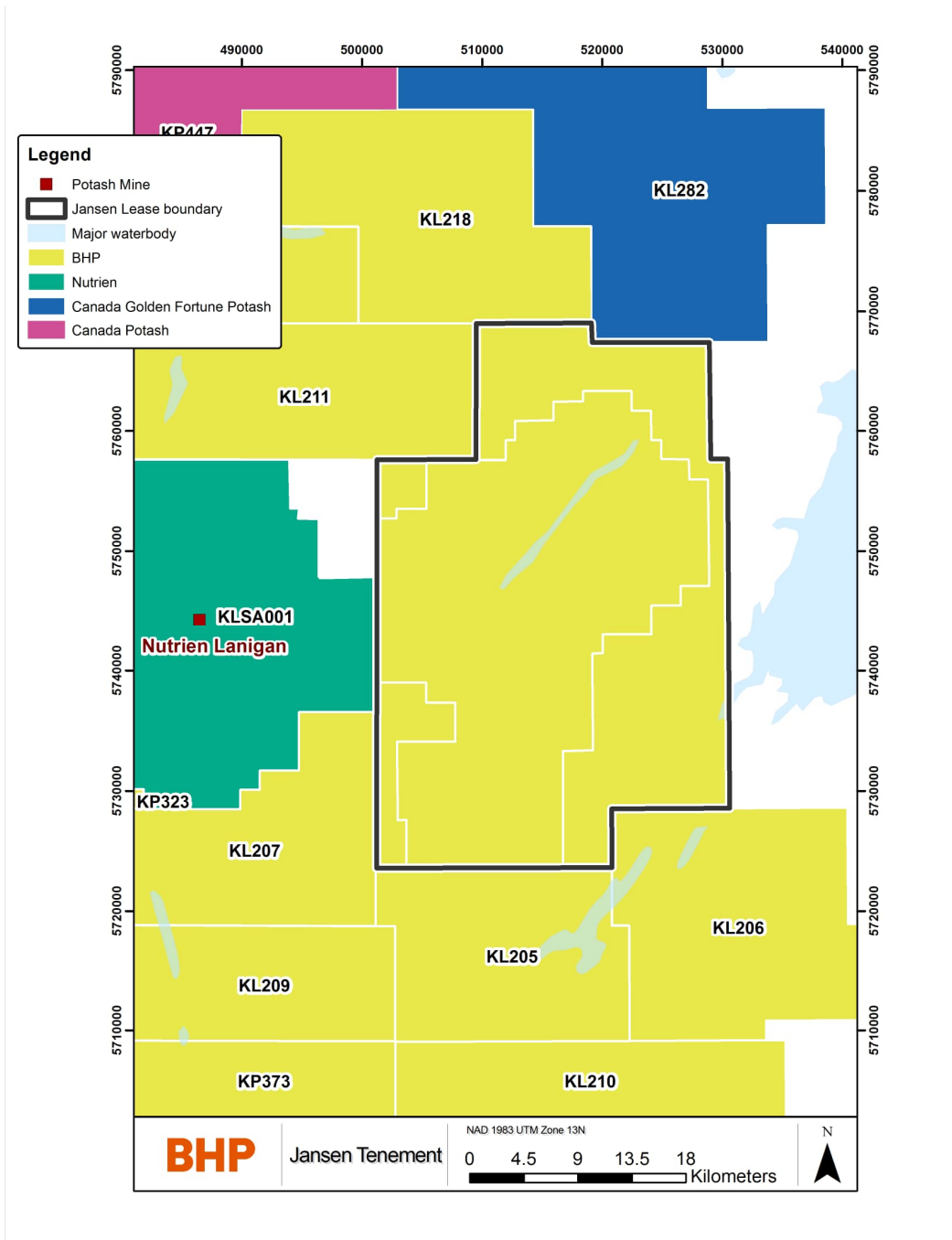

Figure 20-1: Jansen lease and neighbouring potash dispositions and properties.

For personal use only

## 21 Other Relevant Data and Information

Annual Risk Reviews are conducted jointly by Assets and the BHP Resource Centre of Excellence to ensure significant and material risks to Tenure, Mineral Resources and Mineral Reserves are adequately managed. The Risk Review process identifies key reporting changes regarding the annual declaration of Mineral Resources and Mineral Reserves and agreed actions requiring completion prior to BHP's annual reporting. Issues and opportunities identified during the Risk Reviews inform the Annual Assurance Plan and scopes for potential Controls Effectiveness Collaborative Assessment reviews and identify good practice that can be shared across BHP.

For personal use only

## 22 Interpretation and Conclusions

### 22.1 Mineral Resources

The Jansen Mineral Resources are based on available historical data and on an extensive exploration program conducted by BHP Canada at the Jansen project. Knowledge gained by exploration in adjacent properties and other areas of the basin, from publicly available historical data, and from publicly available mining history also contributed to the assessment and classification of the Jansen resource. The limited number of drill hole intersections, core sample sizes, horizontal and vertical resolution of the seismic data are factors that introduce uncertainty into the Mineral Resources estimates. The impact of these were carefully considered during the estimation process and in the classification of the resource areas. It is the opinion of the Qualified Person, that based on the available data, the known limitations of the data, interpretations, and methodologies the Jansen Mineral Resources estimate is considered fit for purpose in supporting and for forming the basis of a Mineral Reserves estimate.

### 22.2 Mineral Reserves

Uncertainties that affect the reliability or confidence in the Mineral Reserve estimate include but are not limited to:

- Future macro-economic environment, including product prices and foreign exchange rate;
- Changes to operating cost assumptions, including labour costs;
- Ability to continue sourcing water from the Saskatoon South East Water Supply;
- Ability to preserve ongoing reliable power supply;
- Changes to mining, hydrogeological, geotechnical parameters and assumptions reflected in mining recovery;
- Ability to maintain environmental and social license to operate;
- Integrity of the shaft liner beyond the design life of 70 to 80 years.

Confidence in the Mineral Reserve is reflected in the applied reserve classifications in accordance with the US SEC S-K 1300 with factors influencing classification including but not limited to mining methods, processing methods, economic assessment and other life of asset and closure assessments.

In the opinion of the Qualified Person, the positive project NPV provides confidence in the Mineral Reserve estimate and the supporting mine plan, under the set of assumptions and parameters used in which they were developed. The Probable Mineral Reserve classification considers the Measured classification of the Mineral Resources classification and the uncertainty of the mining factors.

## 23 Recommendations

The Jansen Stage 1 project is currently in Execution phase. First saleable product is expected in 2026. Jansen Stage 2 is also in Execution with first saleable product expected in 2028. There are no current work plan recommendations for the next financial year outside of the planned Project execution.

For personal use only



## 24 References

The list of the references cited in this report is given below.

BHP (2021) Press Release. BHP approves investment in Jansen Stage 1 potash project. 17 August 2021.

BHP (2023) Press Release. BHP approves US\$4.9 billion investment in stage two of Jansen potash project. 31 October 2023

Fuzesy, A. (1982). *Potash in Saskatchewan, Saskatchewan Industry and Resource Report 181*

Halabura, S. P., Gebhardt, E. and Kuchling, K. (2005). *Technical Report for Subsurface mineral permit KP 286, Jansen Area, Saskatchewan. Anglo Minerals Ltd. SEDAR.*

Halabura, S. P. and Gebhardt, E. (2006). *Technical Report concerning estimation of mineral resource for Upper Belle Plaine sub-member, subsurface mineral permits KP285, KP286, and KP290, Jansen Area, Saskatchewan. Anglo Minerals Ltd. SEDAR*

Mackintosh, A. D. and McVittie, G. A. (1983). *Geological anomalies observed at the Cominco Ltd. Saskatchewan potash mine; in McKercher, R.M. (ed.), Potash 83 Potash Technology – Mining, Processing, Maintenance, Transportation, Occupational Health and Safety, Environment, Pergamon Press Toronto, pp.59-64.*

Ministry of Environment (2018). *Saskatchewan Potash Industry Brine Pond Freeboard Guidelines and Reporting Requirement.*

*The Oil and Gas Conservation Regulations, (1985)*

*The Environment Assessment Act. Saskatchewan*

*Mineral Industry Environmental Protection Regulations, Saskatchewan*

Potash Production Tax and Crown Royalty:

<https://publications.saskatchewan.ca/api/v1/products/112630/formats/126664/download>

## 25 Reliance on Information Provided by the Registrant

The Qualified Persons have relied on information provided by BHP in preparing its findings and conclusions regarding certain aspects of modifying factors, which are listed in Table 25-1.

**Table 25-1: Reliance on Information Provided by the Registrant**

Category	Report Item/ Portion	Portion of Technical Report Summary	Disclose Why the Qualified Person Considers it Reasonable to Rely upon the Registrant
Marketing Plans	Section 16.1	Market Information and Market Entry Strategies	Based on industry experience to date, the marketing plans provided by BHP appear to be reasonable for a new market entrant.
Marketing Information	Section 16.1	Information concerning markets	Information maintained by BHP through a specialist Market Analysis and Economics team.
Marketing	Section 16.2	Contracts required to develop the property	Information maintained by a dedicated Supply team within BHP.
Environmental matters	Section 17.1 Section 17.3	Environmental Studies and Impact Assessments Project Permitting Requirements	Matters related to environmental studies and permitting are undertaken by professional teams within BHP.
Environmental matters	Section 17.5	Closure Planning	Matters related to environmental studies are undertaken by professional teams within BHP. The closure cost estimate represents future costs based on current conceptual expectations of site future conditions. Closure management plans are regularly reviewed and updated to ensure relevancy in current context.
Plans for local groups	Section 17.4 Section 17.7	Social Plans and Agreements with Local groups, Local procurement and Hiring	Matters related to social plans, agreements with local groups, local procurement and hiring are managed by dedicated professional teams within BHP.
Macro-economic Assumptions	Section 19	Foreign Exchange rates (FX) and discount rates	Matters related to discount rate, FX rates, and interest rates are maintained by financial professionals within BHP and the accounting practices are externally audited annually. The discount and FX rates appear appropriate and in line with current market conditions.
Governmental factors	Section 19.1	Royalty and taxation	These are external factors that BHP has to comply with and data is maintained by financial professionals within BHP

**BHP**

**Malus and Clawback Policy**

**October 2021**

(Updated by the People and Remuneration Committee on 1 November 2023)

## Overview

This Malus and Clawback Policy applies to BHP's Incentive Plans. For the avoidance of doubt, these Incentive Plans include (but are not limited to) awards made under the following arrangements:

- Cash and Deferred Plan (CDP)
- Long Term Incentive Plan (LTIP)
- Management Award Plan (MAP)

It should be noted that this Policy is not a substitute for careful reading of the applicable malus and clawback provisions in the relevant Incentive Plan rules or related equity grant, or Incentive Plan participation documentation.

### Mandatory trigger events

BHP is listed on the New York Stock Exchange and as a consequence BHP must apply a Mandatory Clawback Policy to certain officers' incentive based compensation if an accounting 'Restatement' is required. This Mandatory Clawback Policy applies to BHP's Incentive Plans and is attached as an addendum to this policy.

### Discretionary trigger events

The People and Remuneration Committee of the Board has discretion to determine whether any other trigger event has occurred. The following is summary guidance of the types of events that may trigger a pay adjustment in relation to Incentive Plan awards or payments:

1. An error in the Group's financial statements which requires a material downward restatement or is otherwise material or where information has emerged since the award date which would have affected the cash amount or number of shares in respect of which the award was granted or vested (noting that in certain circumstances mandatory clawback may apply under the Mandatory Clawback Policy).
2. Where the People and Remuneration Committee determines that the personal performance of a participant, of their product group or of the Group does not justify vesting or where the participant's conduct or performance has been in breach of their employment contract, any laws, rules, codes of conduct or policies applicable to them or the standards reasonably expected of a person in their position.
3. The performance of the company, business or undertaking in which a participant worked or works, or for which a participant was or is directly or indirectly responsible, is found to have been misstated or based upon any material misrepresentation and which resulted in the award being granted and/or vesting over a greater cash amount or number of shares than would otherwise have been the case.
4. Where any team, business area, member of the Group or profit centre in which the participant works or worked has been found guilty in connection with any regulatory investigation or has been in breach of any laws, rules, codes of conduct or policies applicable to it or the standards reasonably expected of it.
5. An event which has had, may have or, in the opinion of the People and Remuneration Committee, would have if made public, a material adverse effect on the value or reputation of any member of the Group (excluding an event or events which have a material adverse effect on global macroeconomic conditions).
6. Where the People and Remuneration Committee determines that there has been material damage to the Group's social licence to operate.
7. A catastrophic health, safety, environment or community event or events occurring in any part of the Group.

8. An act, omission or event occurs which in the opinion of the People and Remuneration Committee constitutes a material failure of risk management or of other operational systems and controls for which a participant was directly or indirectly responsible or which occurred in any part of the Group's business in which the participant performs a role or for which the participant has direct or indirect responsibility.
9. A participant is found to have contributed to circumstances which give rise to a material loss for any Group Company.

All participants are expected to be vigilant and to draw to the attention of their line managers the occurrence of a possible trigger event. Any identified trigger event shall then be discussed by the Board and / or People and Remuneration Committee at its next meeting to consider the following (without limitation):

- The type of event (e.g. type of risk incurred, timing, assessment of implications for the Company).
- The materiality of the event.
- The identity of the participant(s) involved.
- Action taken to rectify the event (including suspension recommendations – see below).

For events considered material enough to warrant further action, the Practice Leader Executive Remuneration will prepare initial recommendations for any payment adjustment or payment suspension and submit these to the People and Remuneration Committee. The People and Remuneration Committee shall then review and determine the extent to which any adjustment or suspension should be made, and the People and Remuneration Committee's reasons shall be recorded. The Practice Leader Executive Remuneration shall then notify the affected participant and offer the right to appeal, if appropriate.

#### **Suspension of vesting/payment**

Where there is an on-going internal or external investigation the Practice Leader Executive Remuneration shall make suspension recommendations (i.e. delay vesting and /or payment) where:

1. There is prima facie evidence of potential wrongdoing in respect of a participant under investigation such that there is a case for the participant to answer.
2. There is prima facie evidence of an awareness of potential wrongdoing in respect of a participant under investigation that has not been acted on appropriately, such that there is a case for the participant to answer.
3. There are reasonable grounds to suppose that, by reason of a participant's immediate line management responsibilities, a participant could be deemed indirectly responsible or accountable for the potential wrongdoing of a direct report who falls into category 1 or 2 above.

In addition to categories 1 and 2 above, there may be additional circumstances in which the People and Remuneration Committee (or a duly-authorized sub-committee or panel) may consider a suspensive action at its discretion and acting in good faith.

The vesting and / or payment of all affected incentive awards relevant to any participant affected by an internal or external investigation and which could ultimately result in a pay adjustment shall be delayed until such an investigation has concluded and the Company has made a decision and communicated it to the affected participant.

#### **People and Remuneration Committee decision-making**

In reaching a decision about whether to apply a remuneration adjustment, the People and Remuneration Committee will be required to exercise its discretion. The exercise of any discretion is always a question of fact and degree and therefore when applying its discretion, the People and Remuneration Committee should (without limitation):

- Seek to review all relevant information and ask the correct questions.

- Direct itself correctly in law, e.g. adopt a correct construction of the Incentive Plan rules and associated documentation.
- Not arrive at a perverse decision, i.e. a decision at which no reasonable remuneration committee would have arrived at. Discretion must not be exercised in an arbitrary, capricious or irrational way.
- Take into account all relevant factors and disregard all irrelevant factors.

Relevant factors would include (without limitation):

- The type, size and scope of the event.
- The role, level of seniority and responsibilities of the affected participant and the extent to which they have failed to discharge their responsibilities and duties.
- The extent to which an participant has failed to take reasonable measures to promptly identify, assess, report, escalate or address the event in question.
- The value of any remuneration adjustment.

The People and Remuneration Committee's decision and the decision-making process should be clearly recorded and documented.

#### **Participant appeal**

Where a payment adjustment or payment suspension is approved, the relevant participant has the right to request an appeal of the payment adjustment/suspension, e.g. to provide supporting evidence which might justify any actions during an appeal period not exceeding 14 days from the date that the participant was first notified of the potential payment adjustment/suspension.

Any evidence provided from the affected participant shall be provided to the Chief People Officer who shall then make a final recommendation on the payment adjustment and / or suspension, for approval by the People and Remuneration Committee.

#### **Administration**

Nothing in this Policy shall operate to limit or modify the Mandatory Clawback Policy. In reaching a decision about whether to apply a remuneration adjustment, a relevant factor considered by the People and Remuneration Committee would include the value of any remuneration recovered pursuant to the Mandatory Clawback Policy.

**ADDENDUM**  
**Mandatory Clawback Policy**

**I. BACKGROUND**

BHP Group Limited (“BHP”) has adopted this policy (this “Mandatory Clawback Policy”) to provide for the recovery or “clawback” of certain incentive compensation in the event of a Restatement. This Mandatory Clawback Policy is intended to comply with, and will be interpreted to be consistent with, the requirements of Section 303A.14 of the New York Stock Exchange (the “NYSE”) Listed Company Manual. Certain terms used in this Mandatory Clawback Policy are defined in Section VIII below.

**II. STATEMENT OF POLICY**

BHP shall recover reasonably promptly the amount of erroneously awarded Incentive-Based Compensation in the event that BHP is required to prepare an accounting restatement due to the material noncompliance of BHP with any financial reporting requirement under the securities laws, including any required accounting restatement to correct an error in previously issued financial statements that is material to the previously issued financial statements, or that would result in a material misstatement if the error were corrected in the current period or left uncorrected in the current period (a “Restatement”).

BHP shall recover erroneously awarded Incentive-Based Compensation in compliance with this Mandatory Clawback Policy except to the extent provided under Section V below.

**III. SCOPE OF POLICY**

**A. Covered Persons and Recovery Period.** This Mandatory Clawback Policy applies to Incentive-Based Compensation received by a person:

- after beginning service as an Executive Officer,
- who served as an Executive Officer at any time during the performance period for that Incentive-Based Compensation,
- while BHP has a class of securities listed on a national securities exchange in the United States, and
- during the three completed fiscal years immediately preceding the date that BHP is required to prepare a Restatement (the “Recovery Period”).

Notwithstanding this look-back requirement, BHP is required to apply this Mandatory Clawback Policy only to Incentive-Based Compensation received on or after October 2, 2023.

For purposes of this Mandatory Clawback Policy, Incentive-Based Compensation shall be deemed “received” in BHP’s fiscal period during which the Financial Reporting Measure (as defined herein) specified in the Incentive-Based Compensation award is attained, even if the payment or grant of the Incentive-Based Compensation occurs after the end of that period.

**B. Transition Period.** In addition to the Recovery Period, this Mandatory Clawback Policy applies to any transition period (that results from a change in BHP’s fiscal year) within or immediately following the Recovery Period (a “Transition Period”), provided that a Transition Period between the last day of BHP’s previous fiscal year end and the first day of BHP’s new fiscal year that comprises a period of nine to 12 months will be deemed a completed fiscal year.

**C. Determining Recovery Period.** For purposes of determining the relevant Recovery Period, the date that BHP is required to prepare the Restatement is the earlier to occur of:

- the date the board of directors of BHP (the “Board”), a committee of the Board, or the officer or officers of BHP authorized to take such action if Board action is not required, concludes, or reasonably should have concluded, that BHP is required to prepare a Restatement, and

- the date a court, regulator, or other legally authorized body directs BHP to prepare a Restatement.

For clarity, BHP's obligation to recover erroneously awarded Incentive-Based Compensation under this Mandatory Clawback Policy is not dependent on if or when a Restatement is filed.

**D. Method of Recovery.** The People and Remuneration Committee of the Board (the "Committee") will have discretion in determining how to accomplish recovery of erroneously awarded Incentive-Based Compensation under this Mandatory Clawback Policy, recognizing that different means of recovery may be appropriate in different circumstances.

#### IV. AMOUNT SUBJECT TO RECOVERY

**A. Recoverable Amount.** The amount of Incentive-Based Compensation subject to recovery under this Mandatory Clawback Policy is the amount of Incentive-Based Compensation received that exceeds the amount of Incentive-Based Compensation that otherwise would have been received had it been determined based on the restated amounts, computed without regard to any taxes paid.

**B. Covered Compensation Based on Stock Price or TSR.** For Incentive-Based Compensation based on stock price or total shareholder return ("TSR"), where the amount of erroneously awarded Incentive-Based Compensation is not subject to mathematical recalculation directly from the information in a Restatement, the recoverable amount shall be determined by the Committee based on a reasonable estimate of the effect of the Restatement on the stock price or TSR upon which the Incentive-Based Compensation was received. In such event, BHP shall maintain documentation of the determination of that reasonable estimate and provide such documentation to the NYSE.

#### V. EXCEPTIONS

BHP shall recover erroneously awarded Incentive-Based Compensation in compliance with this Mandatory Clawback Policy except to the extent that the conditions set out below are met and the committee of independent directors responsible for executive compensation decisions has made a determination that recovery would be impracticable:

**A. Direct Expense Exceeds Recoverable Amount.** The direct expense paid to a third party to assist in enforcing this Mandatory Clawback Policy would exceed the amount to be recovered; provided, however, that before concluding it would be impracticable to recover any amount of erroneously awarded Incentive-Based Compensation based on expense of enforcement, BHP shall make a reasonable attempt to recover such erroneously awarded Incentive-Based Compensation, document such reasonable attempt(s) to recover, and provide that documentation to the NYSE.

**B. Violation of Home Country Law.** Recovery would violate the laws of the Commonwealth of Australia where that law was adopted prior to November 28, 2022; provided, however, that before concluding it would be impracticable to recover any amount of erroneously awarded Incentive-Based Compensation based on violation of the laws of the Commonwealth of Australia, BHP shall obtain an opinion of Australian counsel, acceptable to the NYSE, that recovery would result in such a violation, and shall provide such opinion to the NYSE.

**C. Recovery from Certain Tax-Qualified Retirement Plans.** Recovery would likely cause an otherwise tax-qualified retirement plan, under which benefits are broadly available to employees of BHP, to fail to meet the requirements of 26 U.S.C. 401(a)(13) or 26 U.S.C. 411(a) and regulations thereunder.

#### VI. PROHIBITION AGAINST INDEMNIFICATION

Notwithstanding the terms of any indemnification arrangement or insurance policy with any individual covered by this Mandatory Clawback Policy, BHP shall not indemnify any Executive Officer or former Executive Officer against the loss of erroneously awarded Incentive-Based Compensation, including any payment or reimbursement for the cost of insurance obtained by any such covered individual to fund amounts recoverable under this Mandatory Clawback Policy.



## **VII. DISCLOSURE**

BHP shall file all disclosures with respect to this Mandatory Clawback Policy and recoveries under this Mandatory Clawback Policy in accordance with the requirements of the U.S. federal securities laws, including the disclosure required by the applicable U.S. Securities and Exchange Commission (“SEC”) filings.

## **VIII. DEFINITIONS**

Unless the context otherwise requires, the following definitions apply for purposes of this Mandatory Clawback Policy:

“Executive Officer” means BHP’s president, principal financial officer, principal accounting officer (or if there is no such accounting officer, the controller), any vice-president of BHP in charge of a principal business unit, division, or function (such as sales, administration, or finance), any other officer who performs a policy-making function, or any other person who performs similar policymaking functions for BHP. Executive officers of BHP’s subsidiaries, as applicable, are deemed Executive Officers of BHP if they perform such policy making functions for BHP. Policy-making function is not intended to include policymaking functions that are not significant. Identification of an Executive Officer for purposes of this Mandatory Clawback Policy will include at a minimum executive officers identified pursuant to 17 CFR 229.401(b).

“Financial Reporting Measures” means any of the following: (i) measures that are determined and presented in accordance with the accounting principles used in preparing BHP’s financial statements, and any measures that are derived wholly or in part from such measures, (ii) stock price and (iii) TSR. A Financial Reporting Measure need not be presented within BHP’s financial statements or included in a filing with the SEC.

“Incentive-Based Compensation” means any compensation that is granted, earned, or vested based wholly or in part upon the attainment of a Financial Reporting Measure.

## **IX. ADMINISTRATION; AMENDMENT; TERMINATION.**

All determinations under this Mandatory Clawback Policy will be made by the Committee, including determinations regarding how any recovery under this Mandatory Clawback Policy is effected. Any determinations of the Committee will be final, binding and conclusive and need not be uniform with respect to each individual covered by this Mandatory Clawback Policy.

The Committee may amend this Mandatory Clawback Policy from time to time and may terminate this Mandatory Clawback Policy at any time, in each case in its sole discretion.

## **X. EFFECTIVENESS; OTHER RECOUPMENT RIGHTS**

This Mandatory Clawback Policy shall be effective as of December 1, 2023. Any right of recoupment under this Mandatory Clawback Policy is in addition to, and not in lieu of, any other remedies or rights of recoupment that may be available to BHP and its subsidiaries and affiliates under applicable law or pursuant to the terms of any similar policy or similar provision in any employment agreement, equity award agreement or similar agreement.